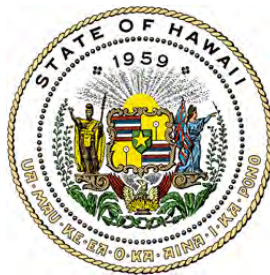


HAWAII GEOTHERMAL  
DRILLING GUIDE

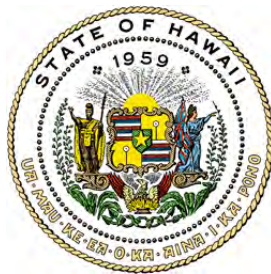
Circular C-126

Prepared by  
GeothermEx, Inc.  
A Schlumberger Company  
Richmond, California



State of Hawaii  
DEPARTMENT OF LAND AND NATURAL RESOURCES  
Engineering Division  
Honolulu, Hawaii

September 2014



NEIL ABERCROMBIE  
Governor

BOARD OF LAND AND NATURAL RESOURCE

WILLIAM J. AILA, JR., Chairperson  
VERNON CHAR, Member at Large  
ULALIA WOODSIDE, Oahu Member  
CHRISTOPHER YUEN, Member at Large  
JAMES A. GOMES, Maui Member  
STANLEY ROEHRIG, Hawaii Member  
THOMAS Oi, Kauai Member

DEPARTMENT OF LAND AND NATURAL RESOURCES

WILLIAM J. AILA, JR., Chairperson  
JESSE K. SOUKI, First Deputy  
WILLIAM M. TAM, Deputy Director - Water  
CARTY S. CHANG, Chief Engineer

## ACKNOWLEDGEMENT

This document was prepared by GeothermEx, Inc. of Richmond, California, for the Hawaii Department of Land and Natural Resources. The work was performed primarily by Amber Falconer, Eduardo Granados, Christopher Klein, and James Lovekin. We wish to gratefully acknowledge the assistance of the staff of the Engineering Division under the direction of Carty Chang, and the valuable suggestions and assistance of all those that discussed the project with us.

Development of this Guide would not have been possible without the cooperation of many professionals in the geothermal industry, national laboratories, and academic intuitions. The authors wish to acknowledge the help of all those who have provided input. Their accumulated knowledge has made our job easier.

## Revision History

Rev. No.	Effective Date	Description	Prepared by	Reviewed by	Approved by
0	5/2/2014	First draft	ADF, EEG	JWL	JWL
1	9/15/2014	Second draft	ADF, CWK	JWL	JWL

## Disclaimer

Any interpretation, research, analysis, data, results, estimates, or recommendation furnished with the services or otherwise communicated by GeothermEx to its customers at any time in connection with the services are opinions based on inferences from measurements, empirical relationships and/or assumptions. These inferences, empirical relationships and/or assumptions are not infallible, and professionals in the industry may differ with respect to such inferences, empirical relationships and/or assumptions. Accordingly, GeothermEx cannot and does not warrant the accuracy, correctness or completeness of any such interpretation, research, analysis, data, results, estimates or recommendation.

Customer acknowledges that it is accepting the services "as is," that GeothermEx makes no representation or warranty, express or implied, of any kind or description in respect thereto. Specifically, Customer acknowledges that GeothermEx does not warrant that any interpretation, research, analysis, data, results, estimates, or recommendation is fit for a particular purpose, including but not limited to compliance with any government request or regulatory requirement. Customer further acknowledges that such services are delivered with the explicit understanding and agreement that any action taken based on the services received shall be at its own risk and responsibility, and no claim shall be made against GeothermEx as a consequence thereof.

# CONTENTS

1. INTRODUCTION .....	1-1
1.1 The Volcanic Domain in Hawaii .....	1-2
1.2 Geothermal Development History .....	1-3
<i>Hawaii (Big Island)</i> .....	1-3
<i>Maui</i> .....	1-6
<i>Statewide</i> .....	1-7
1.3 Geothermal Resource Concept .....	1-7
1.4 Subsurface Conditions .....	1-8
1.5 Transmission and Infrastructure .....	1-9
1.6 Reserves Estimates .....	1-10
1.7 Summary .....	1-10
2. RULES AND REGULATIONS .....	2-1
SUMMARY .....	2-1
2.1 Leasing .....	2-2
2.1.1 Process .....	2-2
<i>State Lands</i> .....	2-3
<i>Reserved Lands</i> .....	2-3
2.2 Permitting .....	2-4
2.2.1 Agency Stakeholders .....	2-5
<i>Federal</i> .....	2-5
<i>State</i> .....	2-5
<i>County</i> .....	2-6
<i>State Agency Responsibilities (DLNR, DBEDT, DOH)</i> .....	2-6
2.2.2 Permit Categories .....	2-7
<i>Land Use (Zoning)</i> .....	2-7
<i>Environmental</i> .....	2-7
<i>Utility</i> .....	2-8
<i>Construction and Operation</i> .....	2-8
2.2.3 Geothermal Operations Permits .....	2-8
<i>Geothermal Exploration Permit (GEP)</i> .....	2-8
<i>Geothermal Drilling Permit (Production and Injection)</i> .....	2-9

	<i>Well Abandonment</i> .....	2-10
2.2.4	Bond Requirements .....	2-10
2.2.5	Streamlining Efforts.....	2-10
2.2.6	Recent Legislative Changes .....	2-12
	<i>Non-invasive Testing</i> .....	2-12
	<i>Night-time Drilling</i> .....	2-12
	<i>Geothermal Resource Subzones</i> .....	2-12
2.3	Environmental Considerations .....	2-13
2.3.1	Land Use.....	2-13
2.3.2	Visibility .....	2-14
2.3.3	Noise .....	2-14
	<i>PGV Operations</i> .....	2-16
2.3.4	Air Quality .....	2-16
	<i>PGV Operations</i> .....	2-18
2.3.5	Water Quality.....	2-18
	<i>PGV Operations</i> .....	2-18
2.3.6	Other Hazards .....	2-19
2.3.7	Benefits .....	2-19
3.	DRILLING.....	3-1
	SUMMARY .....	3-1
3.1	Requirements .....	3-2
	<i>Qualified Personnel</i> .....	3-2
	<i>Logistics and Equipment</i> .....	3-2
3.2	Well Planning .....	3-5
	<i>Objectives</i> .....	3-5
3.2.1	Well Design .....	3-5
	<i>Expected Reservoir Conditions</i> .....	3-6
	<i>Targets</i> .....	3-6
3.2.2	Geothermal Well Types .....	3-7
	<i>Temperature-Gradient Holes (TG Holes)</i> .....	3-7
	<i>Slim Holes</i> .....	3-7
	<i>Full Diameter Wells</i> .....	3-8
3.3	Drilling Programs .....	3-9
	<i>Program Content</i> .....	3-10

	<i>Casing and Cementing Programs</i> .....	3-11
3.4	Drilling Fluids .....	3-12
	<i>Introduction</i> .....	3-12
3.5	Drilling Monitoring .....	3-13
3.6	Special Considerations.....	3-14
3.6.1	Cost .....	3-14
	<i>Slim-Hole Drilling and the Scientific Observation Hole (SOH) Program</i> .....	3-14
3.6.2	Formation Fluids Chemistry .....	3-14
	<i>Scaling</i> .....	3-15
	<i>Corrosion</i> .....	3-15
	<i>Choice of Casing Materials</i> .....	3-15
3.6.3	Equipment .....	3-15
	<i>Deep Slim-Hole Drilling Operations</i> .....	3-15
	<i>Transportation from Outside Hawaii</i> .....	3-17
3.6.4	Tolerance on Vertical Wells .....	3-17
3.6.5	Natural Hazards .....	3-17
	<i>Volcanic Eruptions</i> .....	3-17
	<i>Earthquakes</i> .....	3-18
4.	CASING AND CEMENTING.....	4-1
	SUMMARY .....	4-1
4.1	Introduction .....	4-2
4.2	Regulations .....	4-3
4.3	Casing and Cementing Programs .....	4-3
	<i>Useful References</i> .....	4-3
	<i>Casing Program Factors</i> .....	4-4
	<i>Cementing Program Factors</i> .....	4-5
4.3.1	Casing .....	4-6
	<i>Casing Profiles (Casing Intervals)</i> .....	4-6
	<i>Casing Materials</i> .....	4-7
	<i>Casing-Depth Regulations and Recommendations</i> .....	4-9
	<i>Special Considerations</i> .....	4-11
4.3.2	Cementing.....	4-12
	<i>Introduction to Procedures</i> .....	4-12
	<i>Mud Displacement</i> .....	4-12

<i>Free Water</i> .....	4-13
<i>Pumping Methods</i> .....	4-13
<i>Slurry Components and Characteristics</i> .....	4-16
<i>CaP and SSAS Cements</i> .....	4-17
<i>Foamed Cement</i> .....	4-18
<i>Latex Cement</i> .....	4-18
<i>Additives</i> .....	4-19
4.4 Other Special Considerations .....	4-20
4.4.1 Lost-Circulation Zones (LCZs) .....	4-20
4.4.2 Top Jobs and Backfills .....	4-20
4.4.3 Sacrificial Liners .....	4-21
4.4.4 Strength at High Temperatures .....	4-21
4.4.5 Casing Availability .....	4-22
4.4.6 Fluid Chemistry .....	4-22
<i>Casing Corrosion Resistance</i> .....	4-22
<i>Scaling</i> .....	4-22
5. BLOWOUT PREVENTION .....	5-1
SUMMARY .....	5-1
5.1 Introduction .....	5-3
5.2 Blowout Classification .....	5-4
5.2.1 Surface Blowouts .....	5-4
<i>Casing-Contained</i> .....	5-4
<i>Externally Vented</i> .....	5-5
5.2.2 Underground Blowouts .....	5-5
<i>Internal Wellbore Flow</i> .....	5-5
<i>Outflow at the Casing Shoe</i> .....	5-5
5.3 BOP Equipment .....	5-5
5.3.1 Definitions, Functions, and Planning Design .....	5-6
<i>Definitions</i> .....	5-6
<i>Functions</i> .....	5-6
<i>Planning Design and Component Specifications</i> .....	5-7
5.3.2 BOP Classification .....	5-9
5.3.3 BOP Installation in Hawaii .....	5-9
<i>Surface Casing BOP</i> .....	5-10



		<i>Intermediate Casing BOP</i> .....	5-10
5.3.4		Equipment Testing and Inspection .....	5-10
5.3.5		Special Considerations for Hawaii .....	5-11
		<i>High Wellhead Temperatures</i> .....	5-11
		<i>BOP Anchoring Criteria</i> .....	5-12
		<i>Unpredictable Subsurface Conditions</i> .....	5-12
5.4		Blowout Incident Procedures .....	5-12
5.4.1		Kick Identification .....	5-13
5.4.2		Kick Control .....	5-14
		<i>Shut-in (Kill) Procedures</i> .....	5-14
5.4.3		Post-Completion Blowout Prevention .....	5-15
		<i>Risks in Hawaii</i> .....	5-15
5.4.4		Blowout Prevention in Slim Holes .....	5-16
5.5		Drilling Fluids and Geothermal Well Control .....	5-16
5.6		Drilling Monitoring.....	5-17
5.6.1		Monitoring Rationale in Hawaii .....	5-18
5.6.2		Categories of Monitoring Data .....	5-19
5.6.3		Monitoring for Blowout Prevention .....	5-20
		<i>Bottom-Hole Temperature Variation</i> .....	5-20
		<i>Rate of Penetration</i> .....	5-20
		<i>Drilling Fluid Condition and Circulation</i> .....	5-21
		<i>Tripping the Drill String</i> .....	5-21
		<i>Formation Fluid Entry</i> .....	5-22
		<i>Secondary Mineralization</i> .....	5-22
		<i>Drilling with Air, Aerated Liquids, or Foam</i> .....	5-22
		<i>Summary</i> .....	5-23
5.7		Supervision and Training .....	5-23
		<i>Supervisory Experience</i> .....	5-23
		<i>Drilling Team Training and Drills</i> .....	5-24
6.		WELL COMPLETION & TESTING .....	6-1
		SUMMARY .....	6-1
6.1		Testing Objectives .....	6-2
6.2		Testing Modes.....	6-3
6.3		Testing Duration .....	6-4

6.4	Testing Techniques .....	6-6
	<i>Wireline and Geophysical Logging</i> .....	6-6
	<i>Flow Tests to Atmosphere</i> .....	6-6
	<i>Injection Tests</i> .....	6-7
	<i>Pressure-Transient Tests</i> .....	6-7
	<i>Tracer-Dilution Tests</i> .....	6-8
	<i>Inter-well (Reservoir) Tracer Tests</i> .....	6-8
7.	MONITORING AND REPORTING .....	7-1
	SUMMARY .....	7-1
7.1	Monitoring of Well Integrity and System Performance.....	7-2
7.2	Well and Surface Equipment Maintenance.....	7-5
	<i>Hawaiian Regulations</i> .....	7-5
	<i>Wells Down-hole</i> .....	7-5
	<i>Wellheads and Surface Pipelines</i> .....	7-6
	<i>Plant Equipment</i> .....	7-7
7.3	Well Records and Reporting .....	7-7
	<i>Hawaiian Regulations</i> .....	7-7
	<i>Types of Reports</i> .....	7-8
8.	WORKOVERS, PLUGGING, AND ABANDONMENT .....	8-1
	SUMMARY .....	8-1
8.1	Workovers.....	8-2
8.1.1	Typical Well Issues Requiring Workover Operations .....	8-2
	<i>Brine Chemistry</i> .....	8-2
	<i>Mechanical Failure</i> .....	8-3
	<i>Generation Capacity Decline</i> .....	8-3
8.1.2	Permitting for Workover Operations in Hawaii.....	8-3
8.2	Plugging and Abandonment.....	8-3
8.2.1	Permitting for Operations in Hawaii.....	8-4
8.2.2	Procedures Required by Hawaiian Regulations.....	8-5
9.	EMERGING TECHNOLOGY .....	9-1
	SUMMARY .....	9-1
9.1	Drill Bits .....	9-2

	<i>PDC Bits</i> .....	9-2
	<i>High-Temperature Roller Cone Bits</i> .....	9-3
	<i>Hybrid Drill Bits</i> .....	9-4
	<i>High-Temperature Elastomer Seals</i> .....	9-4
9.2	Drilling Tools and Techniques.....	9-5
	<i>BHA Motors</i> .....	9-5
	<i>Explosive Tools</i> .....	9-5
	<i>Well-Course Maintenance (Measurement While Drilling)</i> .....	9-6
9.3	Rotary Steerable System (RSS) .....	9-6
9.4	Casing While Drilling.....	9-6
9.5	Coiled-Tubing Drilling .....	9-8
9.6	Mono-Diameter Wells .....	9-9
9.7	High-Temperature Cements .....	9-9
	<i>Foamed CaP Cement</i> .....	9-9
9.8	Aerated Mud .....	9-10
9.9	Lost-Circulation Material .....	9-12
9.10	Logging Tools .....	9-12
	<i>Optical Fiber</i> .....	9-12
	<i>Gamma Logs</i> .....	9-13
	<i>Borehole Televiewers</i> .....	9-13
	<i>High-Temperature Components</i> .....	9-14
9.11	Fluid Sampling .....	9-14
9.12	Power-Plant Technology .....	9-15
	<i>Dispatchability</i> .....	9-15
9.13	Trained Personnel and Detailed Procedures .....	9-15
	<i>Stuck Pipe in Hawaii</i> .....	9-15
9.14	Other Advanced Techniques Under Development .....	9-16
	<i>Reinjection of H<sub>2</sub>S</i> .....	9-16
	<i>Drilling-Rig Innovation</i> .....	9-16

# ILLUSTRATIONS

## Tables

- 1.1 Kilauea East Rift Zone - Geothermal Wells Drilled Since 1975
- 1.2 Summary of Reserve Estimates for Hawaiian Geothermal Areas
- 2.1 Composition of Noncondensable Gas in Geothermal Steam
- 3.1 Comparison of Conventional and Unconventional Rigs for Geothermal Applications
- 3.2 Typical Rig Sizes
- 3.3 Examples of Geothermal Brine Chemistry
- 3.4 Comparison of Slim-Hole Drilling vs. Conventional Rotary Drilling
- 3.5 Properties of Drilling Mud
- 3.6 Template for Drilling-Mud Program
- 4.1 Casing Properties under Various Temperatures
- 4.2 Tensile Requirements of Casing Manufactured in Accordance with API specification 5CT
- 4.3 Expected Down-hole Conditions vs. Actual Down-hole Conditions of Well KS-11
- 4.4 Properties of Geothermal Cements
- 5.1 Pressure-Temperature Ratings for Steel Parts
- 9.1 Comparison of Costs of Drilling Bits
- 9.2 Consumables Used in Aerated-Mud Program at KS-14
- 9.3 Components of Drilling Muds for High-Temperature Wells
- 9.4 InnovaRig Specifications

## Figures

- 1.1 Hottest geothermal regions worldwide
- 1.2 Geothermal resources of Hawaii County
- 1.3 Geothermal resources of Maui County
- 1.4 Flow chart for geothermal project development
- 1.5 Map of the Pacific Basin showing the location of the Hawaiian Ridge and Emperor Seamount Chain
- 1.6 Cross-section view of the Hawaiian Ridge showing mantle plume at depth
- 1.7 Geologic map of Hawaii County
- 1.8 Kilauea East Rift Zone
- 1.9 Shaded relief of the KERZ showing principle volcanic features and the location of Ormat's Puna Geothermal Venture

- 1.10 Map showing June 27, 2014 vent from Pu‘u ‘Ō‘ō as of September 12, 2014
- 1.11 Cut-away view of magma pathway and shallow reservoir beneath Kilauea
- 1.12 Location map of the Puna geothermal field and wells drilled as of 2005
- 1.13 PGV location and wellfield showing location of dacite melt encountered in KS-13
- 1.14 Location map of Haleakala Southwest Rift Zone, Maui
- 1.15 Map showing location of Ulupalakua project area
- 1.16 Land-use map of Ulupalakua area
- 1.17 Down-hole temperature profiles for well HGP-A
- 2.1 The various agencies involved in the geothermal permitting process in Hawaii
- 2.2 Land-use district boundaries for the State of Hawaii
- 2.3 Flow chart for geothermal construction permits in Hawaii - Geothermal Regulatory Roadmap
- 2.4 Example of flow chart for exploration permit - Geothermal Regulatory Roadmap
- 2.5 Aerial view of vegetation screen at Mammoth Pacific geothermal power plant
- 2.6 Air-cooled binary geothermal power plant at Puna
- 2.7 Maximum permissible sound levels from HAR Chapter 11-46
- 2.8 Puna air-quality monitoring-station locations
- 2.9 Relative output of CO<sub>2</sub>, expressed in pounds (lbs) per unit of energy (MWh)
- 3.1 Bottom-hole-assembly (BHA) diagram
- 3.2 Tri-cone roller bits and polycrystalline-diamond-compact (PDC) bits
- 3.3 Comparison of relative diameter and depth of exploration wells
- 3.4 Drilling of a temperature-gradient well
- 3.5 Comparison of slim-hole and large-diameter-hole designs
- 3.6 Drilling of a slim hole
- 3.7 Drilling of a full-diameter well
- 3.8 Completion diagram of full-diameter well
- 3.9 Temperature-depth diagram depicting several thermal gradients and their corresponding influence on geothermal gradients at the earth's surface
- 3.10 Circulation of drilling mud
- 3.11 Graph showing PGV process conditions versus solubility of silica
- 3.12 Location map of Hilina fault system south of rift zones on Hawaii
- 4.1 Worksheet for cementing of casing
- 4.2 Typical geothermal casing profile
- 4.3 Theoretical casing-setting depths
- 4.4 Typical wellhead configuration for geothermal well

- 4.5 Working wellhead pressures de-rated for temperature increases
- 4.6 Relative inner and outer casing diameters for satisfactory cementing job
- 4.7 Buttress, Seal-Lock and VAM thread connections
- 4.8 Typical geothermal well-cementing process
- 4.9 Traditional down-hole cementing process
- 4.10 Inner-string cementing process
- 4.11 Reverse-circulation cementing flow direction
- 4.12 Equivalent circulating density (ECD) for conventional vs. reverse-circulation drilling
- 4.13 Reverse-circulation float equipment
- 4.14 Reverse-circulation method using drill pipe stabbed into float collar
- 4.15 Reverse-circulation method using logging tool and radioactive tracer
- 4.16 Deterioration process in a cemented well due to carbon-dioxide (CO<sub>2</sub>) attack
- 4.17 Mud displacement: foamed cement vs. conventional cement
- 5.1 Hydril-type annular preventer
- 5.2 Typical Koomie accumulator unit
- 5.3 Annular preventer and actuating system
- 5.4 Class III BOPE installation (API Arrangement SRRA or SRdaA)
- 5.5 Class III BOP equipment recommended for use in Hawaii
- 5.6 Testing of all connections (except annular preventer)
- 5.7 Simplified drilling-fluid circulating system with monitoring device locations
- 5.8 Typical mud log, showing lithology, temperature, and gas levels
- 5.9 Real-time drilling-monitoring equipment
- 7.1 Example of template for daily drilling report
- 7.2 Example of template for well history report
- 7.3 BLM template for Monthly Report of Geothermal Operations
- 8.1 Calcite scaling inside liner – note plugged slots
- 9.1 Kaldera high-temperature roller-cone drill bit
- 9.2 Kaldera drilling results at The Geysers
- 9.3 Kaldera drilling results at Larderello
- 9.4 Kymera hybrid drill bit
- 9.5 Basic roller-cone technology and new high-temperature / high-pressure (HT/HP) seal packages
- 9.6 Example of rates of penetration while drilling in “sliding” and “rotating” modes
- 9.7 Casing-While-Drilling (CWD) assembly
- 9.8 Coiled tubing rig “revolver”

- 9.9 Comparison of standard and mono-diameter design for hypothetical deep well
- 9.10 Bottom-hole assembly for monobore drilling
- 9.11 Particle-size distribution of geothermal drilling fluid before and after treating with micronized cellulose
- 9.12 Photograph of two particle ranges of micronized cellulose
- 9.13 Typical fibers used for temperature measurement

# APPENDICES

APPENDIX A: REFERENCES .....	A-1
APPENDIX B: GLOSSARY .....	B-1
APPENDIX C: RENEWABLE ENERGY PERMIT CHECKLISTS (FEDERAL, STATE AND COUNTY) .....	C-1
APPENDIX D: GENERIC DRILLING PROGRAM .....	D-1



## 1. INTRODUCTION

This Geothermal Drilling Guide has been prepared at the request of the State of Hawaii Department of Land and Natural Resources to provide a single, comprehensive document that describes geothermal drilling and well-testing operations for the use of potential developers, operators, and stakeholders. This guide is intended as a general reference for common practices currently found in the geothermal industry. For site-specific well programs, detailed analysis of all available project data should be performed in order to ensure compliance with applicable federal, state, and county regulations.

Because the interior temperature of the Earth increases everywhere with depth, geothermal energy exists world-wide. However, geothermal resources that are shallow and hot enough for beneficial use occur in limited areas, often associated with volcanoes. These areas tend to occur along the boundaries of tectonic plates (for example, the Pacific Ring of Fire) and within the plates at certain volcanic “hot spots,” one of which is Hawaii (see Figure 1.1 and Section 1.1).

An awareness of Hawaiian geothermal potential dates back at least to 1881, when King David Kalakaua, the monarch of Hawaii, visited Thomas Edison in New York. The King, seeing Edison's electric lamp, generator and boiler, immediately realized that Kilauea could power electric lamps in Hawaii. The King did not recognize the requirement for wells; rather he thought to set the boilers in Kilauea's hot lava throat, but it is extraordinary that the essential concept of geothermal electric power was grasped by the King of Hawaii over 130 years ago (Patterson *et al.*, 1994b).

Seven geothermal resource areas in the State of Hawaii have been identified as “high-temperature resource areas” with significant potential for electricity generation. Five are located on the Island of Hawaii, and two on the Island of Maui (Lovekin, *et al.*, 2006). The geothermal resource areas on the Big Island of Hawaii are shown in (Figure 1.2):

- Kilauea East Rift Zone (KERZ)
- Kilauea Southwest Rift Zone (KSWRZ)
- Mauna Loa Southwest Rift Zone
- Mauna Loa Northeast Rift Zone
- Hualalai

The geothermal resource areas on Maui are shown in (Figure 1.3):

- Haleakala Southwest Rift Zone (HSWRZ)
- Haleakala East Rift Zone.

Identification of these seven areas is based on several factors, including age of most recent volcanic activity and available data from geology, geochemistry, geophysics, and temperature measurements in shallow wells. These types of data are relatively sparse for all the geothermal resource areas except the KERZ. All seven geothermal resource areas are general zones where exploitable resources are more likely to exist than elsewhere in the State, though specific developable sites in most cases are yet to be determined.

There is currently one geothermal plant operating in Hawaii: the Puna project on the Island of Hawaii, near Pahoa. It is operated by Puna Geothermal Venture (PGV), which is a subsidiary of Ormat Technologies, Inc. The plant started operations in 1993 with a power purchase agreement (PPA) to provide 25 megawatts (MW) to the local electric utility (Hawaii Electric Light Company, HELCO). A subsequent PPA with HELCO allowed PGV to provide an additional 5 MW from the same facility. In late 2011, PGV modified its facility to add 8 MW of plant capacity, using silica-scale control to extract additional heat from existing wells. This expansion was the first new plant capacity in Hawaii in 18 years. The incremental plant capacity was covered under a third PPA with HELCO, allowing a total power output of up to 38 MW (Ormat, 2014).

The only other publicly announced project under development is Ormat's Ulupalakua geothermal project on the Island of Maui, which is currently in the due-diligence phase of development. Commercial development will depend on the results of this due-diligence effort (DBEDT, 2014a).

This document is intended to provide a clear view of the procedures and processes involved in drilling operations and of many other activities that are an integral part of the successful development of a commercial geothermal project. When development operations are conducted in a safe, considerate, and effective manner, the project can be considered a success for operators, personnel, the surrounding community members, and the environment. A diagram of the generalized processes that may be involved in the development of a geothermal project can be seen in Figure 1.4 (Ungemach *et al.*, 2010).

### 1.1 The Volcanic Domain of Hawaii

The volcanic islands that comprise the State of Hawaii (SoH) formed by eruptive volcanism above a convecting mantle plume ("hot spot") that exists at a relatively fixed location under the northwestward-moving Pacific Oceanic plate (Figure 1.5) (Tilling *et al.*, 2010). Over a period of 70 million years, magma formation, eruption, and the continuous drift of the plate have created the chain of volcanoes now called the Hawaiian-Emperor Chain. Each island is a composite of several volcanic centers built up by a succession of lava flows and slowly transported northwestward from the point of origin. The ages of the principal lava flows on the Hawaiian Islands from oldest (northwest) to youngest (southeast) in millions of years are: Niihau and Kauai (5.6 to 3.8), Oahu (3.4 to 2.2), Molokai (1.8 to 1.3), Maui (1.3 to 0.8) and Hawaii (less than 0.7 and still growing); see Figure 1.6.

Because the ocean floor in the central Pacific is very deep, most of the volume of the Hawaiian volcanoes is submarine. On the Big Island, for example, only 11 percent of the total erupted volcanic rock mass stands above sea level, and 89 percent lies below. (The peaks of Mauna Kea and Mauna Loa stand more than 13,000 feet above sea level, yet are 31,000 feet above the sea floor.)

The Big Island comprises five volcanic centers that are progressively younger and more active from northwest to southeast (Figure 1.7) (Sherrod *et al.*, 2007), and Kilauea is the youngest of these. It is estimated that eruptions began on the sea floor from the Kilauea vent between 300,000 to 600,000 years ago, and it has remained active since this time, making the rift zones of Kilauea the most prospective areas for geothermal resources on the Island of Hawaii. Historically, most geothermal development efforts on the Island of Hawaii have focused on the KERZ (Figure 1.8) (Lovekin *et al.*, 2006).

The KERZ comprises a system of basaltic vents, fractures, pit craters and cinder cone lineaments. Eighty percent of the KERZ is covered by basalt flows younger than 500 years (Teplow *et al.*, 2009). Major eruptions in the KERZ took place in 1955 (near what was to become the PGV site) and in 1960 (in the Kapoho village area, approximately six kilometers further east). Eruptions from Pu‘u ‘Ō‘ō began in January 1983 and have continued intermittently since then (USGS, 2014a). Figure 1.9 (Tilling *et al.*, 2010) shows the location of Pu‘u ‘Ō‘ō in relation to the PGV site and Kapoho village. An eruption of lava sourced at Pu‘u ‘Ō‘ō began flowing northeast on June 27, 2014, and was still advancing as of mid-September 2014 (Figure 1.10) (USGS, 2014b).

These eruptions are fed by a shallow magma chamber (Figure 1.11) that feeds molten lava to the summit caldera and feeds lava tubes that lead to satellite cones along the rift zones. The KERZ trends northeast, with active down-dropping on the southeast side that is causing the southern flank of Kilauea to slide into the ocean. The active nature of the area and resulting constant movement is believed to continuously generate new fractures and reopen existing fractures.

The KERZ has very few surface manifestations of the hydrothermal activity at depth, and it shows minimal alteration of rocks at the surface. Deep drilling has demonstrated the existence of a geothermal system at Puna, located between two large normal faults with a fracture system at depth that enables fluid flow (Kinslow *et al.*, 2012). The permeability created by faulting has also allowed relatively young basalt dikes to intrude the KERZ, and these have been intersected in the PGV wells.

The only rock type of any significant volume at Puna is basalt, although one well at Puna encountered molten rock of dacitic composition (Teplow *et al.*, 2009). (Dacite is igneous rock that has a higher fraction of silica than does basalt). The basalts are further characterized as cinders, lavas, hyaloclastite (a product of submarine eruptions that form cemented fragments of basaltic rock and glass), pillow basalt, and basalt dikes. A change from sub-aerial to shoreline-deposited flows occurs at about 3,000 feet in depth, followed by 1,000 feet of "transition zone" hyaloclastite flows, submarine flows to about 6,500 feet in depth, and intrusive dikes below 6,500 feet (GeothermEx, 1994; Fitch and Matlick, 2008). Geothermal reservoir temperatures are highest in the middle of the dike complex and drop off to the north and south of the axis of the rift zone.

## 1.2 Geothermal Development History

Geothermal drilling and development activities in the State of Hawaii have comprised the following (also see Table 1.1):

### *Hawaii (Big Island)*

- 1961: Hawaii Thermal Power Company, associated with Magma Power Company, drilled four shallow wells in the KERZ, very close to the lava fissure vents that erupted in 1955, near the town of Pahoa (Figure 1.12) (Patterson *et al.*, 1994b; Gill, 2011). These holes (TH-1, TH-2, TH-3, and TH-4) were drilled with a cable tool rig, and they ranged in total depth (TD) from 216 to 689 feet. They encountered temperatures ranging from 109° to 203°F (43° to 95°C) and found some hot groundwater. None were judged to be of commercial interest and all were abandoned.
- 1973: The National Science Foundation (NSF) funded a geothermal research program headed by the Colorado School of Mines (Keller, 1974). A well was drilled near the summit of Kilauea

Volcano to a depth of 4,140 feet to obtain subsurface data on the volcano, as well as to determine the nature of any geothermal resource present. The well was located inside Hawaii Volcanoes National Park, and it was therefore never used for commercial applications.

- 1975-76: Following an extensive geophysical survey of the lower KERZ, the University of Hawaii utilized federal, state, and county funds to drill the resource discovery well HGP-A well just south of Puu Honuaua, the initial vent site of the 1955 eruption. HGP-A was drilled with a rotary rig, and it was completed in 1976 at a depth of 6,450 feet. It recorded a maximum temperature of 676°F (358°C) and a total mass flow of approximately 100,000 pounds per hour, with nearly equal amounts of both liquid and steam at a surface temperature of 365°F (186°C) (Thomas, 1982; Boyd, 2002). Well HGP-A powered a 2.8-MW demonstration plant from 1981 to 1989 without any significant change in flowing pressure or steam fraction (Patterson *et al.*, 1994b). The plant was shut down in 1989, and the well was subsequently plugged and abandoned (P&A).
- 1978 - 1979: Privately financed exploration drilling was undertaken by Puu Waawaa Steam Company (STEAMCO) and Geothermal Exploration & Development Company (GEDCO) on the northwestern flanks of Hualalai Volcano on the western side of Hawaii (Fowler *et al.*, 1980). Several geophysical anomalies were surveyed in the area, and two exploratory wells were drilled (FNB No. 1 and FNB No. 2; also known as Steamco 1 and Steamco 2). Commercial temperatures for the time were not encountered in either well, and in 1980 both were converted to water wells.
- 1981 - 1985: Numerous geothermal exploration wells were drilled in the vicinity of HGP-A (Table 1.1).
  - 1981 - 1984: Barnwell Industries drilled three test wells and a sidetrack: Ashida 1, Lanipuna 1, Lanipuna 1 ST, and Lanipuna 6. None sustained commercial flow levels, but high temperatures were measured in Lanipuna 1 (685°F) and Ashida 1 (550°F).
  - 1981 – 1985: Thermal Power Company drilled and tested three wells on its Kapoho State (KS) lease. KS-1 and KS-2 were both commercial producers; however, mechanical damage to the wellbores prevented their development, and they were both subsequently plugged and abandoned. KS-1A was initially tested as a commercial producer, but damage to the wellbore prompted its suspension until PGV repaired it and converted it to an injection well during 1991-1992.
- 1989: Ormat Technologies, Inc. acquired the 500-acre PGV lease located adjacent to the HGP-A site (see Figure 1.12) (Teplow *et al.*, 2009).
- 1989 – 1991: True/Mid-Pacific Geothermal Venture drilled well KA1-1 (also known as TMP-1, KMERZ A-1, or KMERZ-1) in the Wao Kele O Puna Forest. The project location was approximately 8 miles west of PGV and was located within the Kilauea Middle East Rift Zone. The drilling operator on KA1-1 had numerous problems, including stuck pipe, premature liner-hanger setting, stuck casing, shallow lost circulation zones (LCZs), and drill-pipe twist-offs. Despite a sidetrack and three re-drills, no commercial flow was documented from this well (GeothermEx, 2000). The project was also met with considerable public protest. True/Mid-

Pacific abandoned its project after state drilling permits were temporarily suspended for both it and PGV following a 1991 blowout at PGV well KS-8 (Smith, 2013).

- 1990 – 1991: The State of Hawaii undertook the Scientific Observation Hole (SOH) program, which consisted of drilling 3 deep core holes to delineate subsurface temperatures and to determine lithologic and hydrologic properties (GeothermEx, 2000). Two of the SOH wells (SOH-1 and SOH-2) were drilled in the lower KERZ. The third SOH well (SOH-4) was located between PGV and the True/Mid-Pacific well location (see Figure 1.12). These continuously-cored exploratory slim holes ranged in depth from 5,500 to 6,800 feet (Patterson *et al.*, 1994b). The SOH wells helped to prove that favorable high temperatures prevail over a ten-mile interval along the KERZ. (See additional detail about these wells in Section 3.6.1.)
- 1990 – 1993: PGV drilled KS-3, KS-7 and KS-8. All three wells were potentially commercial producers; however, they all sustained wellbore damage. KS-3 was repaired and converted to an injection well; KS-7 suffered a shallow blowout and was plugged and abandoned; KS-8 suffered a major blowout after encountering unexpectedly high pressures at depths shallower than anticipated. Well KS-8 was eventually repaired, tested, and briefly placed on production with a generating capacity of 10 MW in October-November 1992. The well was then plugged and abandoned in November after the wellhead was observed to have “risen” 21-inches, possibly due to thermal expansion of the casing. An interval of collapsed casing was found between 586 and 600 feet during the abandonment operations.
- 1992 – 1993: PGV successfully drilled injection well KS-4 and production wells KS-9 and KS-10.
- 1993: The 30-MW PGV plant began commercial operations. This plant has remained in operation since, with production and injection make-up wells drilled to maintain capacity over time. It remains the only operating geothermal plant in the State of Hawaii. Less information is available in the public domain about later wells drilled by PGV because of the proprietary nature of the data.
- 1999: The EPA issued a new five-year Underground Injection Control (UIC) permit to PGV, allowing continued use of the three existing injection wells and the drilling of up to seven new injection wells.
- 2000: Well KS-11 was completed as a production well to a TD of 6,500 feet (Bour and Rickard, 2000).
- 2003: Well KS-11 was re-drilled and converted to an injection well after the casing was found to be damaged. Well KS-5 was drilled as a production well to supplement production after the original production wellbore of KS-11 was taken out of service.
- 2005: Three wells were drilled at the PGV project: a production well re-drill (KS-10RD), a new production well (KS-6), and a new injection well (KS-13) (Spielman *et al.*, 2006).
  - KS-10 was plugged back and re-drilled, kicking off at 4,699 feet, for a total of 511 feet of new hole in 19 days. The re-drill was put back on production with a capacity of about 7.5 MW worth of steam.

- KS-6 was drilled and completed as a production well near the southwestern edge of the project. It was drilled to 6,532 feet in 65 days.
- KS-13 was drilled toward the northeastern portion of the project to a TD of 8,297 feet in 87 days. The open-hole segment consisted of a 10-9/16-inch hole drilled directionally with mud motor and measurement-while-drilling (MWD) technology to total depth (TD). The well was targeted to cross two eruptive lineaments: the 1955 eruptive fissure and the adjacent cinder-cone lineament (Figure 1.13) (Teplow *et al.*, 2009). Lost circulation occurred numerous times between 4,990 and 7,188 feet measured depth (MD). High torque occurred at 8,163 feet true vertical depth (TVD) where molten rock of dacitic composition was encountered. The molten rock flowed up the wellbore and was repeatedly re-drilled over a 26-foot interval, producing several kilograms of clear, colorless vitric cuttings at the surface. The molten zone is overlain by an interval of strong greenschist-facies metamorphism in basaltic and dioritic dike rock.
- 2006: The Puna Borehole Network was established in the lower KERZ to provide detailed seismic data on the Puna geothermal field. This data is being used to identify fault and dike trends and structures at depth in the area, which is of interest both in terms of drilling targets and volcanic hazard monitoring (Kenedi *et al.*, 2010; see also Section 3.6.5).
- 2010: Well KS-14 was drilled as a production well with 11-3/4-inch casing cemented to 4,878 feet (Rickard *et al.*, 2011a). The total depth of the well is not published.
- 2012: The most recent well at Puna (KS-15) was drilled as a production well, with 11-3/4-inch casing cemented to 4,705 feet (Peters *et al.*, 2013). The total depth of the well is not published.

In the KERZ overall, more than two dozen wells have now been drilled and tested, proving the two-phase resource at Puna at temperatures in excess of 680°F in productive intervals (GeothermEx, 1994). Most major productive zones lie between 4,000 and 7,000 feet below the ground surface, although local permeability has been demonstrated as shallow as 1,800 feet (KS-7) and 3,400 feet (KS-8 and KS-9).

Interest in a project at Hualalai on the west side of the Island of Hawaii has also been expressed, as it is located closer to the electrical load centers near Kona, although no reported assessment efforts have been conducted since 1986 (see Figure 1.2). The following analysis was made for Hualalai during the field survey conducted in the early 1980s under the state-wide Hawaii Geothermal Resources Assessment Program:

“... geologic mapping on the western flank of Hualalai suggests that frequent eruptive activity has occurred during the last 5000 years. Geophysical surveys have identified distinct magnetic, resistivity and self-potential anomalies near the summit of Hualalai, whereas the lower western flank has not shown significant thermal effects. Geochemical data on the lower flanks were similarly unable to identify any obvious thermally induced anomalies. These data suggest that there is a 35–45% probability of a low- to moderate-temperature thermal resource near the summit of Hualalai and a 20–30% probability of a high-temperature resource in this area. Probabilities for comparable resources existing on the lower flanks are estimated at 15–25 and 5% or less, respectively,” (Thomas, 1986).

## *Maui*

Field surveys were conducted on Maui's Haleakala volcano in the 1980s within the lower portions of the three major rift zones (Northwest, Southwest and East; Figure 1.14) (Thomas, 1986), and the following analysis was made for the Haleakala Southwest Rift Zone (HSWRZ):

“...geologic mapping has determined that several flows on this rift are less than 10,000 years of age and that a few are less than 1000 years old. Preliminary geochemical studies were unable to identify unequivocal evidence of thermal effects on the lower rift zone area, whereas geophysical soundings indicated that thermal ground waters may be present at depths of less than 3 km. The probability for a low- to moderate-temperature resource is estimated to be 30–40%, whereas that for a high-temperature resource is placed at 15–25 %” (Thomas, 1986).

More detailed exploration of the HSWRZ is now underway, at Ormat's Ulupalakua geothermal project (Figure 1.15). With Lawrence Berkeley National Laboratory and the University of California at Santa Cruz Ormat as partners, Ormat has received a \$4.9M Geothermal Technologies Program grant to undertake the development of a 3-D subsurface model of the resource, and to drill and test 2 exploration wells (Ormat, 2011).

The project area is on reserved lands occupied by Ulupalakua Ranch, Inc. (of which Ormat, 2011, notes that it was seeking to lease approximately 8,000 acres of surface rights), and also on an adjacent 800-acre state parcel that is used for grazing and ranching activities by Ulupalakua Ranch (Figure 1.16).

Ormat submitted an application for a geothermal exploration permit and mining lease for the Ulupalakua project in early 2012 (Osher, 2012). The Hawaii Board of Land and Natural Resources (BLNR) determined that an Environmental Impact Statement (EIS) was required, and a draft was submitted for public review in February 2012 (DLNR, 2012b). A final EIS was planned to be filed with the Department of Land and Natural Resources (DLNR) in 2014. Additionally, Ormat is seeking to conduct a Cultural Impact Analysis (CIA) on selected activities (ARRA, 2014).

## *Statewide*

Current geothermal development activity at the level of the SoH has largely been driven by renewed interest in geothermal energy due to past resource assessments and legislation on Renewable Portfolio Standards (RPS):

- A state-wide geothermal assessment (GeothermEx, 2005) that estimated combined geothermal potential for Hawaii and Maui in range of 525 to 1,535 MW (see also Section 1.6)
- HB 1464 (2009) setting a RPS goal of 40% renewables by 2030
- The Hawaii Clean Energy Initiative (HCEI) of 2011 setting a RPS target even higher: 70% by 2030

### 1.3 Geothermal Resource Concept

Known and potential geothermal resources in the SoH are likely all to be located in discrete areas that are strongly associated with active or recent volcanism. The most prospective areas overlie volcanic rift zones where deep subsurface conduits allow magma to flow outward from a volcanic center at depth.

Almost all Hawaiian geothermal drilling to date has been confined to the KERZ, where the magma and lava processes are estimated to attain very high subsurface temperatures (1,900°F and higher; Patterson *et al.*, 1994b). (See also Section 3.6.5.)

Prospective KERZ geothermal reservoir targets appear to be situated in the roof rock above deep conduits that feed magma into the KERZ structure. The roof rock is exposed to a cross-rift tensional stress field that allows repeated upward intrusions of planar, near vertical sheets of magma from the deeper conduits, which cool to form dikes (Patterson *et al.*, 1994b). Magma input to this dike-formation process is driven by the hydraulic head in the shallow magma chamber under Kilauea's active vent. Newly formed dikes are likely to contribute more thermal energy to the geothermal reservoir than does conduction from the deep magma conduit itself.

Recent well-log data is limited due to the proprietary nature of PGV's operation. However, the bottom-hole temperatures of wells drilled between 1976 and 2005 ranged from 400 to 680°F at depths between 1,640 and 8,860 feet, and hydrothermal reservoir temperatures are estimated to exceed 680°C (Kinslow *et al.*, 2012). Well temperature logs show modest temperatures (<120°F) until depths of approximately 3,200 - 5,000 feet, at which point temperature increases rapidly, roughly following the boiling-point to depth curve (indicating the presence of saturated steam) (Figure 1.17).

#### 1.4 Subsurface Conditions

Rotary drilling in the high-temperature basalt flow and dike rocks of the PGV project is efficiently accomplished with various circulating fluids (usually water or moderately-weighted muds) while using mud-cooling equipment at the surface and down-hole drilling and logging tools that are rated for high temperatures. Drilling fluids suitable for high temperatures are further discussed in Section 3.4.

The KERZ production-well targets are typically specific fault planes, intersections of predicted fault planes, and/or concentrations of intense fracturing. All these features contribute to low rock strengths in the overlying shallow, near-surface volcanics, which can be a problem when attempting to locate a sound anchor for wellhead blowout-prevention equipment.

The unaltered basalt surface flows at Kilauea have relatively large permeability values of  $>10^{-10} \text{ m}^2$ , but this decreases to  $<10^{-15} \text{ m}^2$  at 3,000 - 6,000 feet depth within the rift zone (Kinslow *et al.*, 2012). As a result, convective circulation at these depths is largely absent, except in fracture zones. The low-permeability dikes that have intruded into the parent rock tend to further compartmentalize the available permeability, creating separated, dike-impounded water systems.

Oceanic island groundwater hydrology has traditionally been described by the Ghyben-Herzberg model, which predicts that basal waters will consist of a fresh-water lens (thickness dependent upon meteoric recharge) floating above sea water due to the difference in density between the two fluids (Kinslow *et al.*, 2012).

To evaluate this concept in greater detail, Dr. Don Thomas of the University of Hawaii has been conducting studies on the hydrology of large ocean-volcanic islands, specifically focused on fluid transport and the water-rock reactions that occur below the shallow basal freshwater lens. After conducting geophysical surveys of the Humu'ula Saddle region between Mauna Loa and Mauna Kea on



the Big Island of Hawaii, the Humu'ula Groundwater Research Project (HGRP) has started its exploratory drilling phase, with funding provided by the U.S. Army and the National Science Foundation (University of Hawaii, 2014).

The fresh water lens in the KERZ has been estimated to be about 225 feet thick, but well data, particularly from HGP-A, show lower salinities at depth than would be expected, with a historic increase of salinity that occurred over time as the well was produced. This indicates a meteoric source (not sea-water) for at least some of the deep hydrothermal fluids, which can be explained by several possible processes: (1) the heat source at Puna could invert the typical density-layered lens as heated seawater becomes buoyant and rises above cold freshwater; (2) the fractures in the KERZ could increase the vertical and lateral permeability for fresh-water recharge from a high hydraulic head on the flanks of Mauna Loa; and/or (3) seawater intrusion from the south rift flanks could be inhibited by the presence of dikes, along with hydrothermal alteration of seaward-facing rock. Issues related to fluid chemistry for drilling and production at Puna are discussed in Section 3.6.2.

Most deep geothermal wells and boreholes in the KERZ show that normal hydrostatic pressures prevail in most of the high-temperature realm. Normal subsurface-fluid pressure gradients should range between 422 psi per 1,000 feet of drilled hole in a freshwater realm, and 433 psi per 1,000 feet in a saltwater realm (Patterson *et al.*, 1994b). Earthquakes in the region may cause existing fractures to widen or may create new fractures, and the observed increase in the salinity of the fluids produced by the HGP-A well could have been caused by seawater intrusion along earthquake-induced fractures (see also Section 3.6.5).

The primary hazard of geothermal drilling in the volcanically active KERZ is the currently unpredictable distribution of fault planes and major fractures. The walls of these geologic structures are commonly sealed by secondary minerals, so they are potential long-distance, vertical conduits for geothermal fluids that can present pressures in the range of 500 to 750 psi above normal hydrostatic pressure, particularly where they extend upward into zones of cooler ground-water. Unexpected fluid entries along such over-pressured fault planes and fractures can cause substantial upsets to well-control procedures, such as happened during the drilling of both KS-7 and KS-8 in 1991. Blowouts of both wells were subdued at major additional costs and eventual loss of the intended well function. Detection efforts before drilling, as discussed in detail in Chapter 5 (Blowout Prevention), should be rigorously applied at every active drilling rig.

A significant additional concern for KERZ geothermal wells follows from the weakness of the near-surface volcanic rocks. Open lava tubes, cinder and rubble deposits, and contraction fracturing in hard, crystalline lava flows, contribute to low rock strengths, vulnerability to hydraulic fracturing and high vertical permeability. These weaknesses may extend to depths of 1,500 - 2,000 feet and can pose special problems for the cementing of surface and intermediate casing strings and for the reliable anchoring of the full blowout prevention (BOP) stack required for drilling into the geothermal zones. See also Section 4.3.

Flow tests in KERZ geothermal wells have identified an H<sub>2</sub>S range of 800 - 1,300 parts per million by weight in the non-condensable gas component (GeothermEx, 1992). Operators drilling with mud and water do not run significant risk of H<sub>2</sub>S releases when penetrating the prospective high-temperature zones, so long as well control is maintained. However, in every Hawaii geothermal well, H<sub>2</sub>S safety and rescue training should be completed by all drilling crew members and renewed annually. Commercial services are available to provide this training (such as the use and maintenance of air packs), which is

applicable in the oil-and-gas industry as well as the geothermal industry. API and California Division of Oil and Gas references cited in Appendix A are also pertinent on this subject.

### 1.5 Transmission and Infrastructure

Between 1982 and 1990, the Hawaii Deep Water Cable (HDWC) project was carried out to examine the technical feasibility of installing a submarine power cable from the island of Hawaii to Oahu, where the major electrical load is located. (At the time it was estimated that up to 500 MW could be used on Oahu, whereas only about 100 MW was needed on the Big Island.) Approximately \$26 million (Federal and State funding) was expended in studies, design, engineering, fabrication and testing (Boyd, 2002). The design criteria stated that the cable(s) would have to withstand the stresses of at-sea deployment, the undersea environment, and be able to reliably conduct electricity for thirty years.

Two large-scale tests were undertaken: the first involved laboratory testing of the proposed cable materials, and the second involved the at-sea testing of the integrated control system to place the cable accurately and to control the residual tension. It was concluded from these tests that the cable met the required guidelines for use as a 300-kV DC sub-marine cable.

While installation of a sub-marine cable was shown to be technically feasible, the cable project did not prove to be economical. Cost proposals demonstrated that the project could not be supported without significant government subsidies, and the political environment has hindered the proposed cable construction (Kinslow *et al.*, 2012).

### 1.6 Reserves Estimates

The available heat resource in the Kilauea East Rift Zone on the island of Hawaii has been estimated to be sufficient to generate around 778 MW of electricity (MWe), and the combined most-likely capacity of the entire Big Island has been estimated to be about 1,396 MWe (Table 1.2; GeothermEx, 2005). There also are potentially developable resources on Maui estimated to be 139 MWe. By comparison, peak demand levels for electricity on the islands of Maui and Hawaii are approximately 200 MWe each, and for Oahu (the most populated island) about 1,200 MWe (HECO, 2013).

Commercial geothermal development requires not just heat, but also permeability – the rocks have to allow hot water to flow through them, and actual permeability can only be proven by drilling. Geothermal development typically proceeds in steps to confirm that output is sustainable: (1) measurements on the surface (considered as low-impact activities or having a small footprint), (2) drilling and well testing (having the highest impact activities during the project), and (3) construction and operation of the initial plant.

Until drilling and testing have been done, resource estimates are typically based on analogy to other areas with similar geology and/or only on the estimated heat-in-place. As a result, early-stage estimates of individual resource magnitude are always imprecise. Hawaii's state-wide Energy Reserves Assessment (GeothermEx, 2005) was based on a probabilistic approach to heat-in-place, and industry experience has shown that sizing initial plants at the lower end of heat-in-place estimates is the best way to minimize the risk of under-performing projects.

## 1.7 Summary

Historical drilling experience in the KERZ of Hawaii has demonstrated that there are potential risks associated with drilling in the vicinity of high-temperature permeable structures, the orientation and extent of which are still imperfectly known. However, since the well-publicized blowouts of KS-7 and KS-8 in the early 1990s, careful monitoring of the drilling process and utilization of experienced drilling personnel have enabled over a dozen new wells and re-drills to be completed and operated safely and with no significant losses of drilling control. The continued operation of the Puna geothermal plant at high capacity factors demonstrates the usefulness of geothermal resources to the Hawaiian economy. It is hoped that this guide will facilitate the continuation of safe and environmentally sound drilling practices as further geothermal development is contemplated at the KERZ and elsewhere in the State of Hawaii.

## 2. RULES AND REGULATIONS

### SUMMARY

- 2.1 Leasing: Defines and describes leasing terms and conditions.
  - 2.1.1 Process: Generally describes the leasing process for state and reserved lands.
- 2.2 Permitting: Outlines the permitting process.
  - 2.2.1 Agency Stakeholders: An overview of the key agencies involved in permitting at the Federal, State and county levels.
  - 2.2.2 Permit Categories: Provides general information on the four types of permits: Land Use; Environmental; Utility; and Construction and Operation.
  - 2.2.3 Geothermal Operations Permits: Details those permits specific to geothermal.
  - 2.2.4 Bonding Requirements: Details on requirements for individual and blanket bonds.
  - 2.2.5 Streamlining Efforts: Recent developments in the permitting process.
  - 2.2.6 Recent Legislative Changes: Relevant laws for geothermal development in Hawaii.
- 2.3 Environmental Considerations: Key environmental issues for geothermal developments:
  - 2.3.1 Land Use: Including well pad, power plant, pipelines, and other infrastructure.
  - 2.3.2 Visibility: Including structures, steam plumes, and lights.
  - 2.3.3 Noise: Including limits, sensors, and abatement.
  - 2.3.4 Air Quality: Including sources, mitigation, and monitoring.
  - 2.3.5 Water Quality: Including groundwater and reservoir fluids.
  - 2.3.6 Other Hazards: Including seismicity, subsidence, and waste.
  - 2.3.7 Benefits: Environmental benefits from geothermal power production.

The State of Hawaii is home to numerous endangered plants and animals, cultural and historic sites, fragile ecosystems and pristine coastlines, all of which are protected by various Federal and State government regulations and the agencies that administer them. Protection of Hawaii's environment necessarily places limitations on geothermal project development, with proposed projects often subjected to meticulous analysis prior to the granting of permits. The primary document that governs this process is *Hawaii Administrative Rules Title 13, Subtitle 7, Chapter 183* (Water and Land Development: Rules on Leasing and Drilling of Geothermal Resources) (HAR 13-183) (DLNR, 1981).

## 2.1 Leasing

In the State of Hawaii, steam and other geothermal resources are defined as mineral property under the *Hawaii Revised Statute Title 28* (DLNR, 1981). A "mining lease" is defined as the right to conduct mining operations, including geothermal resource exploration or development, on "State lands" and "Reserved lands" (on all of which Hawaii claims the ownership of geothermal resources). "Reserved lands" are those owned or leased by any person, in which the state has reserved to itself, expressly or by implication, the minerals or the right to mine minerals, or both. "State lands" includes all public and other lands owned by or in the possession, use, and control of the State.

Leases on State lands are granted on a competitive-bid basis only for an initial leasing term of 10 years. Leases on Reserved lands are granted on a competitive-bid basis by public auction or without auction to the occupier upon a vote of two-thirds of the BLNR Board members. Individual leases may not be less than 100 acres nor greater than 5,000 acres. The royalty rate on geothermal production has been described as being 10 to 20% of the gross amount or value of the geothermal resources produced under the lease (DLNR, 1981), but the exact rate for a lease is determined by the of the Department of Land and Natural Resources (DLNR) prior to the bidding for or granting of a mining lease.

### 2.1.1 Process

Any interested applicant / developer is required to obtain a Geothermal Resources Mining Lease (GRML) application from the DLNR and to submit three copies accompanied by a non-refundable fee of \$100. The application must include:

- A description of the lands which are desired for lease, including a location map of the lands.
- A description of the known or potential geothermal resource desired to be leased for exploration and development.
- A brief preliminary plan for geothermal exploration and development and an assessment of the environmental impact.
- A certificate that the applicant is qualified to hold a mining lease under HAR 13-183-21 (*i.e.*, a U.S. citizen of legal age, or an association of citizens, firms, and corporations organized under U.S. laws), and that the officer executing the application is authorized to act on behalf of the operator / development group.
- A certificate that the total acreage the developer desires to lease does not exceed the acreage limitations under HAR 13-183-28 (*i.e.*, a divided or undivided interest in geothermal resources in state or reserved lands in excess of 80,000 undeveloped acres) (DLNR, 1981).

### *State Lands*

For State lands, the DLNR must publish notices of the lease application submitted, in the county where the land is located. Once approval of a mining lease application is granted, the DLNR publishes a notice of the acceptance which sets the date of a public auction for the lands, a description of the land, the geothermal rights that are to be leased, and the terms and conditions (including rental rates, royalties, etc.). At the auction, the DLNR offers the lease to the highest responsible qualified bidder. After winning a bid, the developer/operator must pay the first year's rent, plus a \$500 deposit and submit a plan of drilling operations to the DLNR that must include for each well to be drilled:

- The proposed location and elevation above sea level of the derrick, the proposed depth, the bottom-hole location, the casing program, the proposed well-completion program, the size and shape of the drilling site, the planned excavation and grading.
- Existing and planned access roads, their locations, access controls, and lateral roads.
- Location and source of water supply and road-building material.
- Location of camp sites, air strips, and other supporting facilities.
- Other areas of potential surface disturbance.
- The topographic features of the land and the drainage patterns.
- Methods for disposing of well effluent and other waste.
- A narrative statement describing the proposed measures to be taken for protection of the environment, including (but not limited to) the prevention or control of: (a) fires, (b) soil erosion, (c) pollution of the surface and ground water, (d) damage to fish and wildlife or other natural resources, (e) air and noise pollution and (f) hazards to public health and safety during lease activities.
- A geologist's preliminary survey report on the surface and sub-surface geology, the nature and occurrence of known or potential geothermal resources, surface water resources, and ground water resources of the site.
- All pertinent information or data that the chairperson may require to support the plan of operations for the utilization of geothermal resources and the protection of the environment.
- Provisions for monitoring deemed necessary by the Chairperson of the BLNR to insure compliance with these rules for the operations under the plan.

### *Reserved Lands*

For Reserved lands, the DLNR passes the application to the BLNR, which determines whether the proposed project would be of benefit to the State and then must vote by a two-thirds majority to lease the land without public auction. After the BLNR approves the land for lease, the DLNR must notify the surface occupier and offer the Right of First Refusal to lease the land for six months. If the surface occupier does not lease the land, the DLNR is able to lease the property to the applicant / developer. The applicant / developer must then submit a plan of operations to the DLNR, which must include the same items listed above for State lands.

There have been no lease offerings or sales in the State of Hawaii for more than 20 years but, for the Ulupalakua project on Maui, Ormat has reportedly been applying for geothermal mining leases on both State and Reserved lands (DLNR, 2012b). The status of these lease applications is unknown.

## 2.2 Permitting

Geothermal permitting is generally defined as gaining legal permission to use a geothermal resource and exists as a process that follows successful leasing (see Section 2.1), often with some overlap. Typically, the geographic location of a resource determines which regulations are applicable, which agency has jurisdiction, and thus which permits are required.

The exact steps taken for a specific project will therefore vary, but a general outline of the process is as follows:

- Gain access to lands (usually secured with leasing, but surface rights may differ from subsurface geothermal/mining rights).
- Contact local and state agencies to determine the requirements of local land-use laws including zoning, land-use, and building permits.
- Contact Federal agencies if required.
- Secure water rights if applicable.
- Secure mineral rights as needed (also usually secured with leasing).
- Prepare environmental review as required by the National Environmental Policy Act and/or State environmental laws.
- Obtain exploration permit if required.
- Obtain well-construction permit (in Hawaii, overlaps with the plan of operations that must be submitted to the DLNR, see Section 2.1).
- Drill exploration, production, and injection wells.
- Identify the composition of the resource which may affect the level of environmental impacts, waste disposal, *etc.*
- Determine fluid-disposal plan and obtain permits for underground injection or surface disposal.

The Hawaii State Energy Office has a website providing access to the available federal, state and county permits that are related to the process above, at: <http://energy.hawaii.gov/renewable-energy-project-permitting-in-the-state-of-hawaii>. In the *Guide to Renewable Energy Facility Permits in the State of Hawaii* there is a set of tables for federal, state and county level permitting which lists the permits that could be necessary given a specific task or activity. These tables have been included in this guide as Appendix C (DBEDT, 2013).

Although the permitting process has a reputation for being overwhelmingly complex and lengthy, recent efforts have been made to streamline it and provide guidance on navigating the various agencies involved. The State strongly urges developers / operators to procure a consultant familiar with the Hawaiian permits process, and to contact the relevant permitting agencies as a first step, so that an integrated strategy on

permitting is developed that takes into account the areas of responsibility (sometimes overlapping) of the different agencies.

In addition to consulting the permitting agencies directly, the State strongly recommends that applicants consult with the State Energy Office prior to submitting permit applications, as the language used in certain applications can trigger other permits or approvals not otherwise required (DBEDT, 2013).

Detailed information about State efforts and available resources to assist permitting is given in Section 2.2.6.

### 2.2.1 Agency Stakeholders

Permits are administered at the Federal, State and county levels. The set of agencies involved with a particular project depends on the location (that is, the land category or district) and the scope of work proposed (Figure 2.1), but can include the following.

#### *Federal*

For Federal level permits:

- Environmental Protection Agency (EPA) – which issues Underground Injection Control (UIC) permits for geothermal injection wells, with support from the state-level DOH (see below).
- Army Corp of Engineers (USACE) – which is potentially involved through the Clean Water Act if wetlands or streams are impacted.
- US Fish and Wildlife Service (USFWS) - responsible for implementing Section 7 of the Endangered Species Act on land.
- National Marine Fisheries Service (NMFS), a division of the National Oceanic and Atmospheric Administration (NOAA) within the Department of Commerce - responsible for implementing Section 7 of the Endangered Species Act at sea.
- Department of Energy (USDOE), Department of Interior (USDOI), including the Bureau of Land Management (BLM) and Department of Agriculture (USDA) – which may be involved with permitting under the National Environmental Policy Act (NEPA) if providing funding or grants for geothermal projects.

#### *State*

For State of Hawaii permits (see additional detail below):

- Department of Land and Natural Resources (DLNR) – which is the lead leasing and permitting agency for geothermal resources.
- Department of Business, Economic Development, and Tourism (DBEDT) – which plans and coordinates energy programs for the State.
- Department of Health (DOH) – which has responsibilities in public health and the environment that relate to geothermal development.
- Department of Agriculture (DOA).



- Public Utilities Commission (PUC).

*County*

For county-level permits:

- Department of Planning (DOP) – which issues the Special-Use Permit that may be required (successor to the formerly-required Geothermal Resource Permit, or GRP).
- Public Works Department (PWD) – which issues Grading Permits (well pads, access roads, reserve pits, *etc.*) and Building Permits.
- Department of Research and Development – which provides leadership in local communities through programs related to (among others): energy, economic development and community development. The Hawaii County Energy Coordinator is located in this office, and the State of Hawaii recommends that all geothermal applicants contact the Coordinator early in the planning process (DBEDT, 2013).

*State Agency Responsibilities (DLNR, DBDT, DOH)*

Two main divisions within DLNR share responsibility for geothermal development: the Land Division, which administers leasing of geothermal resources, and the Engineering Division, which oversees the regulation of geothermal exploration and development activity, including (but not limited to) the issuance of drilling permits, compliance with leasing and drilling regulations and providing overall technical and program support to the Department.

Permits issued and regulated by DLNR include:

- Geothermal Exploration Permits (see Section 2.2.4).
- Geothermal Well-Drilling Permits (see Section 2.2.4).
- Conservation District-Use Permits (see Section 2.2.3).

DBEDT plans and coordinates energy programs through its Energy Resources Coordinator within its Hawaii State Energy Office. These programs establish long-range plans and facilitate the State’s transition from oil dependency to local, clean-energy resources. DBEDT does not issue permits for geothermal projects, but facilitates implementation of Section 343 of the Hawaiian Environmental Policy Act. DBEDT has been instrumental in efforts to clarify and streamline the permitting process for geothermal and other renewable energy sources.

Several branches of DOH are involved with geothermal permitting: Noise and Radiation, Clean Air, Underground Injection Control, and Emergency Response. DOH responsibility includes permits to implement certain federal programs, such as the National Pollution Discharge Elimination System (NPDES) (including permits for construction of drill pads and access roads); and the Resource Conservation and Recovery Act (RCRA) (including permits for disposal of solid wastes, such as scale from wellbores). DOH further coordinates with the federal EPA in granting and administering Underground Injection Control (UIC) permits for geothermal injection wells.

Since April 1, 2011, it has been required to submit to DOH a Site-Specific Construction Best-Management-Practice Plan with an application for a National Pollutant Discharge Elimination System (NPDES) permit (Clean-Water Branch Notice-of-Intent General Form) (DBEDT, 2013).

### 2.2.2 Permit Categories

In the State of Hawaii, there are four broad categories of permits: Land Use, Environmental, Utility, and Construction and Operation. Some general information on these categories is provided below and the more specific permits that are required for geothermal projects are discussed in Section 2.2.4.

#### *Land Use (Zoning)*

Hawaiian land districts were established in 1961 (Act 187-61) in order to classify all lands into one of four categories (see Figure 2.2, from DBEDT, 2014c):

- Urban districts
- Rural districts
- Agricultural districts
- Conservation districts

Land-use permits affect the activities that can take place within each category and the different districts are regulated at different levels of government. DLNR has primary jurisdiction in Conservation districts, and the other districts are regulated by county Planning Commissions.

Land use as it pertains to geothermal drilling is further discussed in Section 2.3.1.

#### *Environmental*

Environmental permits pertain to laws that regulate pollution or certain other impacts, such as the Clean Air Act (CAA), the Clean Water Act (CWA), the Safe Drinking Water Act (SDWA), and the Endangered Species Act (ESA). They are implemented through processes established by related laws at all levels of government, such as the federal National Environmental Policy Act (NEPA) and the Hawaiian Environmental Policy Act (HEPA).

Environmental reviews are conducted at the federal, state, and county levels. Under the federal NEPA, agencies are required to make a determination as to whether a proposed project must undergo a detailed environmental review or if it is categorically excluded from such a review. At the state level, Hawaii's EIS law (Hawaii Revised Statutes, HRS 343) requires the preparation of Environmental Assessments (EAs) and Environmental Impact Statements (EISs) for many development projects. An initial determination on the need for an EA or EIS is issued on the basis of criteria set forth in HRS 343 (DLNR, 2014b). Once a Notice of Determination requiring an environmental review is issued, the developer must prepare either an environmental assessment (EA) or an environmental impact statement (EIS).

Environmental considerations relating to geothermal development are further discussed in Section 2.3.

### *Utility*

Utility permits affect infrastructure for distributing electricity, water, natural gas, and the like. Within the State of Hawaii, such permits are administered through local utilities, with oversight by the Public Utilities Commission (PUC).

Hawaii's smaller electrical grids can have an impact on permitting, considering which areas need additional supply and which transmission lines are able to absorb additional energy loads. The Hawaii State Energy Office (HESO) recommends contacting the appropriate utility early in the planning stage to discuss interconnecting to the electrical grid (HSEO, 2013). HSEO also states that some projects submitted for permit approval will not be approved by the local utility or the Hawaii Public Utilities Commission (PUC), as some permitting agencies will want assurances from the developer or utility that a given project is likely to be approved for interconnection before the permits will be processed.

### *Construction and Operation*

Construction and operation permits apply to energy-related structures, buildings, roads, water systems, and the like. They ensure that such structures and systems are built and operated according to standards that protect the public interest. Constructing a geothermal power plant requires numerous permits from Federal, state, and local governments, related to transporting construction materials, encroaching upon Federal and state right-of-ways, demolishing existing structures, and building new structures (Figure 2.3).

#### 2.2.3 Geothermal Operations Permits

Permits specific to the development of a geothermal project can be found online (DLNR, 2014c; DLNR, 2014d; DLNR, 2014e; DLNR, 2014f) and are as follows.

#### *Geothermal Exploration Permit (GEP)*

Geothermal resources exploration has been defined by the State of Hawaii as either: "conducting non-invasive geophysical operations, including geochemical operations, remote sensing, and other similar techniques; or drilling exploration wells for, but not limited to, the extraction and removal of minerals of types and quantities."

The application for geothermal exploration must be submitted to DLNR and must include:

- Applicant information (operator/developer), including name, address and contact information.
- A description of the exploration activities that will occur.
- A description of the lands upon which exploration activities will occur.
- A location map showing all lands to be entered, such as tax map key.
- Planned dates of commencement and conclusion of activities.
- A statement agreeing to file a bond, meeting the requirements of HAR 13-183-68 and within 20 calendar days after the notification of the application being approved (see Section 2.2.5).
- Land-owner details for all parcels upon which exploration activities will be conducted, including the owner's name, company, address and contact email / phone number.

- A statement from the land owner or lessee confirming or denying their consent to entry, and if consent is not granted, a description of the efforts undertaken to gain consent and the reasons given for denial.
- Signatory acceptance of the Statement of Compliance under which the applicant agrees that all work will be performed in accordance with DLNR Rules and all federal, state, and county requirements.
- Payment of a \$100 non-refundable application fee.

The application will then go through the DLNR review process and must also be processed by the BLNR. Once the application is deemed complete, the average processing time is within 60 days.

*Geothermal Drilling Permit (Production and Injection)*

Geothermal resources development has been defined by the State of Hawaii as the “development or production of electrical energy from geothermal resources and direct use application of geothermal resources.” The term does not include "geothermal resources exploration."

The primary reference document for rules on planning, application and actual drilling is HAR 13-183, specifically sections 183-65 through 183-76 (DLNR, 1981). The specific requirements for applying for a "permit to drill, modify, modify use, or abandon wells" begin in Subchapter 8. Each application must include:

- Applicant (operator/developer) information, including name, address, land owner information (if not applicant) and the existing Geothermal Resources Mining Lease (GRML) and Geothermal Exploration Permit (GEP) numbers.
- Well designation (exploration, production or injection) and activity type (new, maintenance, modify use, modify well, plug and abandon), including a description of the work to be undertaken.
- Well location showing the tax-map key, site elevation, and well location according to established property corners, GPS location and land-use classification.
- A statement of purpose and extent of proposed work, including an estimate of depths between which discovery, production, injection, or plugging will be attempted.
- A Drilling and Casing Program description, including a plan or drawing showing the proposed work and vertical section of the well; this is the essential element for DLNR staff evaluation of the application. The Drilling and Casing Program is further discussed in Section 3.3.
- A statement agreeing to file a bond, meeting the requirements of HAR 13-183-68 within 10 calendar days after the notification of the application being approved (see Section 2.2.5).
- Signatory acceptance of the Statement of Compliance under which the applicant agrees that all work will be performed in accordance with DLNR Rules and all federal, state and county requirements.
- Payment of a \$100 non-refundable application fee.

Permits under a GEP or GRML will be administratively processed by the DLNR. Once an application is deemed complete, the average processing time is within 60 days.

#### *Well Abandonment*

According to the DLNR, all wells and test borings must be properly abandoned and permanently sealed to protect the ground-water resources of the State of Hawaii from contamination and waste and to protect public health and safety, whenever:

- The well has served its purpose, or
- The use of the well has been permanently discontinued, or
- The well is not being properly maintained, or
- The physical condition of the well is causing a waste of ground water or is impairing or threatens to impair the quality of ground-water resources, or
- The well is in such a state of disrepair that its continued use is impractical or it is a hazard to public health or safety.

The lessee/operator must first file a permit application with the DLNR – Engineering Division in advance of abandoning a well (DLNR, 2014d; DLNR, 2014e).

Further details on well abandonment can be found in Section 8.2.

#### 2.2.4 Bonding Requirements

As noted in Section 2.2.4, the State of Hawaii requires that every mining lessee file a bond made payable to the State, made conditional upon performance of all requirements of chapter HRS-182 (DLNR, 2012a) and the existing geothermal mining lease. The bond must be in a form approved by the DLNR and amounts are as follows:

- Individual Bonds - The bonding amount is \$10,000 for a surety bond on a geothermal exploration project (payable to the state conditioned upon compliance with all terms and conditions of the exploration permit), and \$50,000 per well for an indemnity bond on a geothermal development project (for the drilling, re-drilling, deepening, maintaining, or abandoning of any well).
- Blanket Bonds – The bonding amount is \$50,000 for a surety “blanket bond” for any number of exploration permits on a geothermal exploration project, and \$250,000 for an indemnity “blanket bond” on any number of geothermal wells (new production or injection, modification to use or type, plug and abandonment, etc.).

#### 2.2.5 Streamlining Efforts

Over the last few years, efforts to streamline the permitting process have been made by all levels of government.

Stakeholders involved in the Hawaii Clean Energy Initiative (HCEI; a partnership launched in 2008 between the State of Hawaii and the U.S. Department of Energy) recently identified permitting as a major

barrier to renewable energy development in the State (Busche *et al.*, 2013). To address this barrier, HCEI began a multi-year project to improve transparency in the permitting process.

In 2012, the Hawaii State Energy Office (HSEO), as a part of the HCEI, released a series of 11 permitting guidebooks intended to be used by developers planning to develop renewable energy projects in Hawaii: seven provide resource-specific information about approvals at the state and federal levels for all renewable energy types, and the other four provide county-specific information about renewable resource permitting, as identified in late 2009 (DBEDT, 2010a; DBEDT, 2010b). The *Federal and State Approvals for Geothermal* guidebook contains information about approvals at the state and federal levels for geothermal project developers, although it is somewhat dated because of recent legislative changes (see Section 2.2.7).

Building on these guidebooks, HSEO launched the interactive online *Renewable Energy Permitting Wizard* tool in August 2012, which allowed users to identify the Federal, State, and County permits required for a specific renewable energy project in Hawaii based on input provided by the user (DBEDT, 2014b). This was the first multi-jurisdictional central resource on permitting made available to project developers. More information is available at the following website:

<http://wizard.hawaii-cleanenergyinitiative.org/>.

In January of 2013, as a means to promote further understanding of the permitting process for renewable energy facilities in Hawaii, HSEO additionally published the *Guide to Renewable Energy Facility Permits in the State of Hawaii* (DBEDT, 2013).

In June 2013, the U.S. Department of Energy (USDOE) in partnership with the National Renewable Energy Laboratory (NREL) launched the online Geothermal Regulatory Roadmap (GRR). The GRR aims to provide a roadmap (via flow charts) to illustrate the permitting process (Figure 2.4). Charts are being created for several states, including Hawaii. The roadmap was developed at the federal and state levels, allowing for future expansion to the local (county) level, to develop a working guide for agency, industry and policymaker use in an effort to understand regulatory processes and timelines and identify potential areas of concern. The roadmapping initiative currently covers ten states (California, Nevada, Hawaii, Alaska, Idaho, Utah, Oregon, Montana, Colorado, and Texas) and coverage of four additional states (Washington, New Mexico, Arizona, and Wyoming) is under development as of FY2014.

More information is available at the following website:

[http://en.openei.org/wiki/Hawaii/Geothermal#tab=Regulatory\\_Roadmap](http://en.openei.org/wiki/Hawaii/Geothermal#tab=Regulatory_Roadmap).

The *Hawaii Geothermal Assessment and Roadmap* was compiled by the Pacific International Center for High Technology Research (PICHTR) for the Hawaii Natural Energy Institute. This document discusses the evolving roles of both state and county agencies in the development of Hawaii's geothermal resources, including summaries of interviews with agencies involved (PICHTR, 2013).

County permits, where specific requirements have been adopted, also include administrative-type permits, such as grading and grubbing permits, building permits, lighting, noise limits, etc. The specific requirements for geothermal project development are not addressed in this guide, although they typically affect planning and drilling operations. More information is available at the following website:

<http://energy.hawaii.gov/renewable-energy-project-permitting-in-the-state-of-hawaii>.

In order to further streamline the permitting process, the way forward should include:

- Additional clarity on exactly which permits are needed. For example, the Permitting Wizard (DBEDT) and the Geothermal Regulatory Roadmap (NREL) are not completely compatible.
- Coordination among agencies to minimize overlap and facilitate timely decisions.
- Acquisition of more comprehensive resource data to inform public debate. (The permitting process should allow for sufficient exploration activity to be undertaken to better-define and clarify what is at stake.)
- Continuing to promote mechanisms for local involvement and comment, as people need to feel that their lifestyles and values are protected.

#### 2.2.6 Recent Legislative Changes

##### *Non-invasive Testing*

In 2012, an exemption was granted by the Hawaii Environmental Council clearing the way for non-invasive testing of potential geothermal energy sources, without the need for time-consuming and costly environmental reviews (Smith, 2012c). Going forward, companies would be allowed to conduct surface exploration operations that have low-to-no impact on the environment without the need for an initial Environmental Impact Study (EIS). Any company seeking to further develop an exploration program by drilling thermal-gradient or exploration wells would still be required to submit an EIS.

##### *Night-time Drilling*

Also in 2012, a bill was introduced in the Hawaii County Council that would ban night-time drilling in an effort to reduce noise impacts. Opponents of the ban noted that imposing a restricted drilling schedule of 12 hours per day would increase the time it takes to drill a well three-fold, as the trip times in and out of the hole would increase, as would the starting and stopping of operations each day (Smith, 2012b). Opponents also argued that wellbore instability as a result of thermal cycling and intermittent circulation periods would be greater as a result of the ban and thus increase the chances of drilling failure. Despite these concerns, the ban was approved by the Hawaii County Council in November 2012. The ban has imposed a restriction on conducting geothermal drilling operations between 7 pm and 7 am within one mile of a residence (County of Hawaii Bill No. 25; Smith, 2012a). PGV's current county-permitted operations are reported to be exempt from the ban until they exceed their currently-permitted capacity of 60 MW (Smith, 2012a).

##### *Geothermal Resource Subzones*

Act 97 was passed in 2012 by Hawaiian State Legislature eliminating the requirement for Geothermal Resource Subzones, which had been established in 1983. The intention of Act 27 was to provide greater flexibility in exploration and development of geothermal resources, and it also had the effect of diminishing permitting authority at the county level (later restored in April 2013 with passage of House Bill 252).

## 2.3 Environmental Considerations

According to HAR 13-183-87, protection of the environment includes the responsibility of the operator of any well to:

- Conduct exploration, drilling, and development operations in a manner deemed necessary by the Chairperson of the BLNR to provide maximum protection of the environment;
- Rehabilitate disturbed lands;
- Take all precautions deemed necessary by the chairperson to protect the public health and safety; and
- Conduct operations in accordance with the intent and objectives of these rules and all other applicable federal, state, and county environmental legislation.

Adverse environmental impacts from geothermal-related activity must be prevented or mitigated through enforcement of these rules and all other applicable federal, state, and local standards, and the application of existing technology (DLNR, 1981).

Key environmental issues for geothermal in Hawaii are the risk of well blowouts, hydrogen sulfide emissions and drilling noise. Technical solutions exist to mitigate these impacts.

### 2.3.1 Land Use

Under HAR 13-183, drilling and operating plans must be designed so that the operations will result in the least possible disturbance of land, water and vegetation. Existing roads are to be used where feasible. Entry upon certain environmentally fragile land areas may be either seasonally restricted or restricted to special vehicles or transportation methods that minimize disturbance to the surface. All drilling plans must provide for the reclamation and re-vegetation of all disturbed lands in a manner approved by the BLNR. Land reclamation may include preparation and seeding with prescribed wildlife food and plant cover, or improved with acceptable substitutes that will equal or enhance the food values for indigenous wildlife species and domesticated animals. Temporary fencing of reclaimed areas may be required to facilitate land restoration.

Geothermal projects typically have a number of components that affect land use and issues specific to Hawaii include:

- Well pads:
  - Directional drilling allows several wells on each pad, which minimizes surface disturbance. Steam-water separators may be located on these pads as well.
  - Well pads are typically several hundred feet on a side.
- Pipelines:
  - Steam-field pipelines comprise the “gathering system” (bringing produced fluids to the plant) and “disposal system” (transporting fluids to injection wells). The pipelines typically have expansion loops (right-angle bends that accommodate thermal expansion and contraction).



These can be horizontal, or they may extend vertically (about 15 to 20 feet) to allow for road access underneath the pipe, avoiding the need for additional roads to circumvent the system.

- Power plant (or power block):
  - For binary plants, air-cooled condensers comprise a high proportion of the plant area.
- Access roads:
  - Roads must be constructed to accommodate geothermal exploration, development, and production activities. The extent of road-building activities at a particular location will be influenced by the existing road infrastructure.
  - Widening of roads may have to occur in some locations to accommodate the transportation of large equipment to drill sites; however, truck-mounted drilling units (used for temperature-gradient holes and deeper “slim” holes) typically can pass on existing roads.
  - HAR 183-13 requires that road placement avoid volcanic hazards as much as possible. Road designs must be submitted to the counties for construction permit approval. Further specifications on road dimensions are provided in Geothermal Technology Circular C-108 (Kubacki, 1984). (See other relevant information in Section 3.6.5.).
- Average footprint of a geothermal project is on the order of 1 acre per MW:
  - For example, a 20-MW plant might have 2-3 well pads comprising 4-6 acres, a power block of 4-8 acres, and pipelines and roads comprising another 4-6 acres, or 12 to 20 acres overall. This estimate will vary based on resource conditions and topography.

### 2.3.2 Visibility

The visual impact of a geothermal power plant tends to be mitigated by the fact that there is no need to store fuel brought from off-site, there are no tall stacks, and there are either no emissions or just steam is visible (USDOE, 2014c). Further mitigation may be achieved by siting in an obscure area, planting natural vegetation and painting structures to blend into the surrounding environment. A good example of vegetation used for visual mitigation is the Mammoth Pacific geothermal power plant in California (Figure 2.5).

The power plant and the steam gathering system are typically the largest objects in an operating well field. Most other visual impacts from geothermal projects are temporary, including those of the drilling rig and construction equipment.

Visibility issues specific to geothermal projects in Hawaii include the following.

- Height of structures:
  - Visibility makes air-cooled binary (or flash/binary hybrid) the likely choice of plant technology, because air-cooled plants are typically shorter than a 3-story building. Such plants are in use at PGV (Figure 2.6). In contrast, water-cooled plants have cooling towers that can rise to five stories or more.
- Steam plumes and evaporation clouds:

- Most venting of geothermal steam occurs during drilling and well testing, which are periodic. Steam plumes from power plants are not routine. Any steam venting that does take place represents a loss of resource, and may require chemical abatement of H<sub>2</sub>S. Operational practices at the PGV project have been adapted to keep steam venting to a bare minimum, including during drilling and testing.
- Evaporation clouds occur only at water-cooled plants (where they can rise to hundreds of feet).
- Lights at night:
  - Some lights are needed for safe operation.
  - Lights can be shielded to minimize visibility offsite.

### 2.3.3 Noise

In 1996 the State of Hawaii enacted statewide noise standards under the *Hawaii Administrative Rules Title 11, Chapter 46* (Community Noise Control) (HAR 11-46) (DOH, 1996), which established limits to allowable noise levels including geothermal under state law, according to land zoning classification (PICHTR, 2013). According to these standards, the maximum general noise levels that may be imposed by external operations on persons present in three environments are:

- Residential Home: 55 dB(A) daytime, 45 dB(A) nighttime
- Business / Apartments: 60 dB(A) daytime, 50 dB(A) nighttime
- Agricultural / Industrial settings: 70 dB(A)

These limits are subject to County-level enforcement and potential loss of operating permits if exceeded without special permission.

The primary sources of geothermal project noise that can affect these limits are drilling (engine noise from rig motors and pumps, generators and the handling of drill pipe in the derrick and loading racks) and fluid venting (steam and water released to the atmosphere during drilling and during well testing). Noise from power plant facilities does not present a significant issue. A geothermal power plant can be noisy at locations within the power plant itself, but noise levels at the perimeter of the plant are rarely significant.

Kubacki (1984) has reported that within 100 feet of the source the drilling-rig noise can vary from 60 decibels to 98 decibels and initial-venting noise can vary from 90 to 125 decibels.

Technology exists that can abate the drill rig noise to levels off-site that are generally found to be acceptable. Acoustic shielding was employed during the Scientific Observation Hole (SOH) program in the KERZ in the early 1990's. More recently, shielding has been successfully applied to allow geothermal drilling in a rural, tourist-oriented area of Italy, in close proximity to holiday farms and villages (Lazzarotto, and Sabatelli, 2005), and similar technology has been applied to allow oil-and-gas drilling to occur in urban areas of the Los Angeles basin (Murdock, 2010).

To abate the noise of venting, various forms of insulated steam-water separators and mufflers can be used, including stack-pipe insulators, cyclone mufflers and rock mufflers. Kubacki (1984) reported that

periodic operational venting noise at 100 feet distance is about 50 decibels if the flow is directed through a pumice-filled rock muffler.

The original design standard for the HGP-A Wellhead Generator Project specified that the noise level one-half mile from the well site must be no greater than 65 decibels. Construction of a rock muffler at the facility reduced noise levels during project operations to about 44 decibels at the fence line of the project (Kubacki, 1984).

### *PGV Operations*

PGV is located on land zoned as a Class C zoning district that includes agriculture, country and industrial lands and, as of 2013, all of the PGV activities have been conducted within the maximum permissible sound levels as set forth Class C zoning in HAR 11-46-4 (PICHTR, 2013; DOH, 1996). Class C zoning (agriculture, etc.) districts allow 70 dBA at any time of the day or night as measured at the property line.

However, if development occurs on land zoned as residential, conservation, preservation, public space, open space, or similar type lands, the limit would be lowered according to HAR 11-46 to 55 dBA during the day, and 45 at night at the property line, compared to the 70 dBA allowed on agricultural, country and industrial lands (Figure 2.7) (PICHTR, 2013; DOH, 1996).

DOH has been involved in checking noise levels during PGV drilling operations in recent years. Residents or citizens can call a DOH hot line if there are any concerns. (While there is no online internet access to noise monitoring data, members of the public can request this information either verbally or in writing). DOH responds to complaints of noise after checking the source and follows up with calls to the complainants.

If an operator's activities are expected to exceed the allowable levels, then a noise permit must be procured pursuant to HAR 11-46-7. Sound-level measuring devices are calibrated by a third party on an annual basis.

#### 2.3.4 Air Quality

Current regulations concerning air-quality when constructing or modifying a facility (and the necessary permit to operate) are based on *Clean Air Amendments of 1977, Title I, Section 165, 40 CFR 52.21 PSD regulations, HRS Chapter 342, and Administrative Rules of the DOH, Title 11, Chapters 59 and 60* (PICHTR, 2013).

Most air-quality impacts from geothermal exploration projects are temporary. The sources are usually combustion engines for equipment and fugitive dust. The short-term combustion emissions can include such pollutants as CO (carbon monoxide), NO<sub>2</sub> (nitrogen dioxide), SO<sub>2</sub> (sulfur dioxide) and PM<sub>10</sub> (Particulate Matter < 10 microns in size) or precursor air pollutants such as VOCs (Volatile Organic Compounds) and air toxics (diesel PM, acetaldehyde, benzene, and formaldehyde). However, typically the amounts are small enough so as not to violate any air-quality standards.

Fugitive dust is generated during grading of the drill site and any access roads, or other grading, and it can be controlled by watering or applying an organic, non-polluting dust inhibitor, depending on the availability of water. In some cases during the field-development phase, water from the geothermal

resource can be used to water the roads once tested and approved by the Regional Water Quality Control Board for use in that capacity.

Air-quality-related processes that are specific to geothermal projects include:

- Some non-condensable gas (NCG) is present in most geothermal steam.
  - The main NCG component is carbon dioxide (CO<sub>2</sub>). At most geothermal projects world-wide, CO<sub>2</sub> is typically present at more than 80 volume % of the total NCG. In the Puna district, in contrast, the fraction of CO<sub>2</sub> is much lower.
  - The balance of NCG commonly is hydrogen sulfide (H<sub>2</sub>S) and other gases (nitrogen, argon, methane, hydrogen, ammonia and traces of other species). At most geothermal projects world-wide, H<sub>2</sub>S is at most a few percent of the total NCG. In the Puna district, the fraction of H<sub>2</sub>S is much higher (see below).
  - In geothermal reservoirs, the NCG remains in solution in the liquid phase unless boiling occurs. If there is boiling (either in the reservoir, the wellbore, or in surface facilities), nearly all of the NCG partitions into steam.
- There is some potential for NCG emissions during drilling.
  - Traces of reservoir NCG can dissolve into drilling mud and be released at the surface.
  - Somewhat larger amounts of NCG can be released at the surface if compressed air is used as the circulation fluid.
  - Larger amounts will be released, unless abated, if there is flow or venting from the well either during drilling or testing.
  - The risk of a well blowout with larger NCG emissions does exist; however, current drilling techniques and practices make such blowouts very unlikely.
  - The H<sub>2</sub>S component of the NCG is highly toxic and must be handled with proper equipment and procedures wherever and whenever releases are possible. The primary danger of H<sub>2</sub>S arises if “dry” (moisture-free) NCG is released from a gas cap in a well, into a well cellar, or as a plume into the atmosphere. If, instead, moisture and oxygen are present, the H<sub>2</sub>S typically is oxidized quickly, forming a local plume of “acid rain” that is rarely of health concern but is potentially corrosive. Abatement of the H<sub>2</sub>S in planned releases is not difficult and is commonly done wherever required by regulations or safety concerns.
- In power plant systems, the NCG produced from wells is either re-injected into the reservoir (as at PGV) or released to the atmosphere after chemical removal of the H<sub>2</sub>S if regulations require (as at most steam turbine power plants where air-quality regulations require abating H<sub>2</sub>S before the other NCG are released).
- At most geothermal projects world-wide (including PGV), the amount of CO<sub>2</sub> in the reservoir liquid is distinctly smaller on a MWe (megawatt electricity production) basis than the CO<sub>2</sub> released by a coal- or diesel-fired power plant, even without injecting the NCG back into the reservoir.

An example of the composition of separated steam from Puna (well HGP-A) is given in Table 2.1.

#### *PGV Operations*

The operations at PGV must comply with *Hawaii Administrative Rules (HAR) Chapter 11-59, Ambient Air-Quality Standards and Chapter 11-60.1, Air Pollution Control*. The Hawaii State air standard for hydrogen sulfide is 25 parts per billion on an hourly averaging basis at the property line (PICHTR, 2013). The standard has been set to protect public health and is also designed to minimize nuisance odors, although many people can smell hydrogen sulfide at lower levels. Permit issuance has been delegated to the State (specifically the Clean Air Branch of the DOH).

PGV is also operating under a DOH-issued Non-covered Source Permit (NSP) that regulates air emissions from the geothermal power plant, well-field, and geothermal exploratory/developmental wells. The permit incorporates operational limitations and monitoring, record keeping, reporting, and testing requirements, including a requirement that PGV maintain three ambient air-quality monitoring stations, “PGV-A,” “PGV-B” and “PGV-C” (currently these are maintained by an independent third-party contractor hired by PGV) (PICHTR, 2013). These three air-quality monitoring stations are located downwind in the prevailing wind direction (Figure 2.8) (DOH, 2013). The DOH permit also requires that PGV have three monitoring stations in place. A fourth DOH-operated station monitor, “Puna E,” is calibrated and maintained by the State Laboratory Division/Air Surveillance and Analysis Section.

Members of the public can access PGV’s current air-monitoring station data at:

<http://www.punageothermalventure.com>. Those who do not have internet access can call the PGV Information Line for recorded general information. The public can access current DOH Puna E air monitoring data at: <http://emdweb.doh.hawaii.gov/air-quality>. Those who do not have internet access can call the Clean Air Branch (CAB) of DOH in Honolulu.

As of early 2014, the County of Hawaii was considering the installation of additional fixed gas monitors to be located in the Puna area (Callis, 2014).

The Clean Air Branch of DOH has stated that air permits for future geothermal developments would be handled in a similar way to the PGV air permit. Assuming that future developments employ a closed-loop system similar to the PGV system, it is likely that a minor source permit would suffice, mainly addressing fugitive emissions of H<sub>2</sub>S (PICHTR, 2013).

#### 2.3.5 Water Quality

##### *PGV Operations*

At the PGV and presumably at future geothermal projects in Hawaii:

- Geothermal operations are designed to be conducted in a way that protects shallow groundwater.
- Reservoir fluids in production wells are kept isolated from shallow zones by several concentric strings of casing that are cemented inside the wellbore.
- Fluids discharged from the plant are injected back into reservoir through hang-down liners, and the annulus between the hang-down liner and cemented casing is filled with nitrogen to monitor for any shallow leaks.

- Construction of groundwater monitoring wells may be necessary if existing wells cannot provide an accurate representation of the project area's shallow groundwater quality.
- Periodic sampling and analyses of groundwater monitoring wells is required to detect potential contamination of the basal aquifer from geothermal fluids.

The construction, operation, and abandonment of PGV's injection wells are currently regulated by the Underground Injection Control (UIC) permitting process. The UIC permits for the PGV plant have been issued separately by both the Federal Environmental Protection Agency (EPA) and the State Department of Health (DOH) Safe Drinking Water Branch. Pursuant to these permits, the casing integrity of the PGV injection wells has been continuously monitored in the upper 2,000 feet to guard against leaks of deep geothermal fluid into shallow ground water (GeothermEx, 2000).

PGV has no permit with the Clean Water Branch of DOH under Water Quality Standards, as there is no discharge to surface waters.

Any project that disturbs an acre or more of land requires a construction storm-water permit from the Clean Water Branch (PICHTR, 2013).

#### 2.3.6 Other Hazards

Other potential environmental hazards associated with geothermal energy include:

- Induced seismicity:
  - Micro-earthquakes in the vicinity of injection wells can, and at some projects do, occur where there is geothermal fluid injection. They appear to be related to the contraction of hot rock when contacted by cooler injection water.
  - The magnitudes of such earthquakes are generally at a Richter magnitude of <2.0 and can only be detected by seismometers. Larger earthquakes (about magnitude 3.0) have also been reported.
  - Induced seismicity has not been a significant concern for the geologic conditions at Puna.
- Subsidence:
  - If reservoir pressures decline, the ground surface may subside. Most pronounced examples of subsidence have been in situations where little or no produced geothermal water was being returned to the reservoir.
  - This has generally not been a problem where reservoir pressures maintained by injection, as at PGV.
- Hazardous Waste:
  - PGV is a generator of hazardous waste from the maintenance and activities of the plant. Waste drilling mud may require testing and may be regulated by the Solid and Hazardous Waste Branch of DOH.

### 2.3.7 Benefits

There are benefits of geothermal power that can help counteract environmental damage caused by other energy sources. If the point of reference for a proposed development is limited to the land in a natural state, then any development will appear to be a degradation of the environment. However, when electric power is wanted or needed, there are environmental advantages of geothermal power that can be illustrated by comparison with other energy sources. These include:

- Lower greenhouse-gas emissions.
  - Geothermal power generation emits less CO<sub>2</sub> per unit of energy generated than combustion-based sources (oil, gas, coal, bio-fuels). CO<sub>2</sub> is one of the principal greenhouse gases associated with climate change. A graph showing a comparison of CO<sub>2</sub> emissions at geothermal plants versus other combustion-based resources can be seen in Figure 2.9.
  - Dams and nuclear plants avoid greenhouse gas emissions, but have their own environmental liabilities. Geothermal plants cause no flooding of watersheds (as with dams) and no radioactive residues (as with nuclear power)
- Steadier power output than wind or solar facilities.
  - A higher capacity factor means fewer MW of plant capacity are required for a given electricity demand. Capacity factors for geothermal plants with adequate resource supply are characteristically above 90 %. In comparison, wind plants have capacity factors in the range of 30 to 40 %. The intermittent nature of wind and solar power means that more plants need to be built to achieve the same degree of reliability of electricity supply.
- Dispatchable generation.
  - To avoid thermal stresses, geothermal wells are best operated continuously at a steady rate. However, the power plant can be operated so as to allow utilities to “dispatch” power (that is, to adjust power output from a given plant in a way that matches changing loads on the grid). The recent 8-MW PGV expansion is an example of a geothermal plant that provides dispatch-enabled generation and has diminished the need for “peaking plants” to otherwise generate the needed MW.
- Smaller footprint.
  - Geothermal power uses less acreage than solar collectors per MW of power plant capacity.
- Lower visibility.
  - Geothermal plants can often be sited so that topography minimizes visual impact.
  - This contrasts with wind turbines, which characteristically have to be prominently positioned to catch the wind.
- Direct-use applications.
  - Use of lower-temperature geothermal resources (for example for crop drying) can displace the use of other fuels.

- Potential synergy with use of hydrogen fuel.
  - This is still at the pilot stage of development in Hawaii, but it looks very promising.
  - When not being used to meet peak loads, geothermal plants could use spare capacity to generate hydrogen fuel from water.
  - This hydrogen could be used to power cars and trucks, thus diminishing the use of gasoline or diesel.
  - Early applications of hydrogen fuel in on the Island of Hawaii are expected to be in public-transit buses. Potential future applications could be in rental car fleets that service the tourist industry.
  - The transport of hydrogen-fuel canisters could be done using hydrogen-powered trucks.

The use of geothermal plants to generate hydrogen would mean less reliance on transmission lines to make commercial use of geothermal power. One of the challenges to geothermal on the Big Island has historically been that the best-known resource (KERZ) is on the opposite side of the island from load centers near Kona. Transmission lines to bring power across the island would have a significant environmental impact. If hydrogen fuel becomes more widely used in Hawaii, new geothermal power plants could derive their primary revenue from hydrogen, while still supplying electrical power to users in vicinity of these plants – without the need for major new transmission lines. The same approach could make it possible to transfer geothermal-derived energy between the islands by boat, thus bypassing (or at least deferring) long-term decisions about sub-sea cables.



## 3. DRILLING

### SUMMARY

- 3.1 Requirements: Considerations for selection of drilling personnel, logistics, equipment and tools, and contracting.
- 3.2 Well Planning: Main components, considerations and objectives of a well-planning program.
  - 3.2.1 Well Design: Basic components important for proper well design.
  - 3.2.2 Geothermal Well Types: The three main types of geothermal wells (temperature-gradient holes, slim holes and full-diameter wells).
- 3.3 Drilling Programs: Main components, considerations, and objectives of a drilling program.
- 3.4 Drilling Fluids: The functions, necessity, and capabilities of drilling fluids.
- 3.5 Drilling Monitoring: General information on monitoring active drilling processes.
- 3.6 Special Considerations: Key items for consideration when designing a drilling program.
  - 3.6.1 Cost: Smaller-diameter slim holes.
  - 3.6.2 Formation Fluids Chemistry: Specifically scaling, corrosion, and materials.
  - 3.6.3 Equipment: Considerations for smaller-diameter wells and transportation issues.
  - 3.6.4 Tolerance on Vertical Wells: For vertical and deviated wells.
  - 3.6.5 Natural Hazards: Volcanic eruptions and earthquakes.

### 3.1 Requirements

Drilling is an essential and expensive aspect of geothermal wellfield exploration, production and maintenance, and resources with high temperatures and hard, fractured formations are the most expensive to drill, log and complete. Because drilling and well completion can account for more than half of the capital cost of a geothermal power project, project economics can significantly improve by containing the costs of these activities. There are several approaches to this, such as increasing the penetration rate, extending bit or tool life, avoiding mechanical problems (twist-offs, stuck pipe, *etc.*), increasing per-well productivity through multi-lateral completions and using wide-diameter completions, which increase the cost per well but reduce the total number of wells needed.

Geothermal drilling operations in Hawaii have been successfully conducted for several decades; however, operational challenges still exist, including the specific drilling and pressure-control conditions described in Section 1.4, limited availability of equipment, challenging transportation logistics, and possible volcanic hazards. In addition, Hawaii drilling operations are exposed to a high level of regulatory review and public scrutiny. Problems with certain previous drilling operations (see Section 1.2) have resulted in adverse public reactions and continuing evolution of the regulations that control geothermal development. Geothermal developers in Hawaii need to maintain a transparent, active public relations campaign to support all of their active drilling operations, particularly in the KERZ, and need to highlight the benefits of reliable geothermal electric power to the local community (see Section 2.3.7).

#### *Qualified Personnel*

Only well qualified, experienced professionals should assume the responsibility and immediate management/supervision of geothermal drilling operations. It is critical that an integrated team of geologists, drilling engineers and on-site drilling supervisors direct the actual operations in accordance with the approved drilling and casing program that they have prepared, and the team will need to act in accordance with prudent practice when upset conditions occur. On-site drilling supervision should not be less than excellent; this is every operator's lowest-cost, lowest-risk, and most promising path to a successful well completion. The operator alone holds full responsibility for attaining the first-class work and safety practices that can best protect the project's drilling operations from unanticipated events.

The drilling contractor should be carefully selected after detailed assessment of their equipment (see below) and personnel. All rig foremen, crew members, and engineers should be qualified geothermal drilling personnel, and an ongoing, effective training program should be instituted to ensure that all personnel are familiar with the project's individual characteristics. Detailed planning and a core group of dedicated experts, as required in any frontier class of drilling operation, are essential to the safety and success of the project, and to the management of project costs.

#### *Logistics and Equipment*

Drilling operators must organize and manage logistics and support services, commonly from sources in California and Texas. Marine transport schedules between Hawaii and California seaports control all bulk or heavy shipments. Air transport has been employed in emergency situations (such as when a replacement part or special tool is needed as soon as possible), but high costs and the physical size of some equipment are serious constraints on air shipping. Backup equipment and material inventories must be carefully evaluated and determined.

Drilling rig selection typically requires prior assessment of the following parameters:

- Rig type (conventional rotary, top-drive or coring).
- Maximum hook load.
- Rig footprint.
- Pump capacity.
- Drilling-fluid and cleaning requirements.
- Drill-string and bottom-hole-assembly design.
- Drill-bit selection.
- Down-hole motors or hammers.
- Availability of fishing tools.
- Definition of the information that will be on the request for bids.
- Number of shipping loads (large parts, containers, *etc.*) to mobilize the entire rig system.

Basic information about the mechanical parameters is as follows.

- **Rigs** – The drilling rig provides the motive power necessary to rotate the bit, the weight on bit (WOB) necessary to crush the rock, and the ability to circulate the drilling fluid. This requires systems and processes that allow individual pieces of equipment to serve the various functions in the integrated system (e.g., power supply, hoisting, drilling-fluid circulation, drill-string rotation, and blowout prevention). A rotary rig utilizes a rotating table on the rig floor to turn the drill-string. On a top-drive rig, the drill-string is turned by an electric or hydraulic motor hanging beneath the travelling block above the rig floor. A coring rig is typically used only for exploration and scientific observation holes.
  - The rotary drilling rigs likely to be used in Hawaii are rated for drilling to a maximum depth of about 16,000 feet. Table 3.1 provides a comparison of technical parameters for a conventional rig, an improved conventional rig, and an unconventional rig. Operational requirements and economics dictate the sophistication of drilling rigs necessary. Typical rig sizes are listed in Table 3.2.
- **Hook load** – The hook load is the total force pulling down on the rig hook, including the weight of the drill-string, drill collars, and any ancillary equipment. If the maximum hook load is too limited, the rig will not be able to drill as deep and will have less pulling power if the drill bit gets stuck.
- **Footprint** - The footprint of the rig is the total area necessary to house the rig, equipment, and facilities on the well pad.
- **Pump capacity** – The mud pump system comprises a reciprocating piston/plunger device designed to circulate drilling fluid under high pressure down the drill-string and back up the annulus. The capacity of a pump should consider the depth of the wellbore to be drilled, the

diameter and resistance of flow, and the makeup of the mud (density, viscosity, etc.). The deeper the hole, the greater the resistance, and thus the greater the pumping capacity needed.

- **Fluids and cleaning capacity** - The primary function of drilling fluid is to remove the cuttings from the bottom of the hole to facilitate drilling efficiency. In addition, the drilling fluid cools and lubricates the drill-string, cools the wellbore during drilling operations, controls formation pressure, maintains hole integrity and provides the transport mechanism to get the cuttings to the surface. Cleaning capacity refers to the equipment used to remove the cuttings from the fluid before it is re-circulated down-hole. See further detail in Section 3.4.
- **Drill string and Bottom-hole Assembly (BHA)** – For the bit to perform properly, it requires rotational force, drilling-fluid circulation, and downward force to crush the rocks. The BHA provides these essential requirements (Figure 3.1). The BHA is the connection between the rig and the bit, and it includes a wide range of mechanical tools designed to effectively drill under a variety of down-hole conditions. The type and condition of the drill string (between the rig and the BHA) is also important to avoid failures such as twist-offs.
- **Bits** – The standard bit used in conventional geothermal well drilling is the tri-cone roller bit (Figure 3.2). There are numerous types best suited to different conditions. Polycrystalline diamond compact (PDC) bits have been utilized more recently in oil and gas fields, but are not commonly utilized on geothermal wells.
- **Down-hole Motors** – A positive-displacement drilling motor (PDM) mounted at the bottom of the drill string uses the hydraulic horsepower of the drilling fluid to drive the bit. Commonly referred to as mud motors, PDMs are used extensively for directional (deviated) drilling. Down-hole hammers, used less frequently, use the same hydraulic force to drive a hammer bit.
- **Fishing Tools** - Fishing is the process of removing lost objects or damaged equipment from the well. Individual rigs are typically equipped with some form of fishing tools; however, due to the complications often involved in fishing jobs, it can be more economical to rely on service companies to furnish the tools and specialized personnel when the need arises.

When selecting a contractor, the lowest bidder should be considered only after a careful evaluation of all equipment, personnel and expected drilling challenges. Focusing on reduction of mobilization costs and the day rate for the rig is not likely to be a successful approach. A more prudent approach to effective cost control is to look for high-quality personnel and equipment under the drilling contract. Additionally, if substantial directional drilling requirements are anticipated, then good margins of rig capacity and power are essential.

The Department of Health (DOH) or other regulatory agencies may require specific noise-control measures on and around the rig that will affect the choice of equipment (see Section 2.3.3). Hawaii's guidelines for noise control during drilling are strict, and operators should expect to make modifications to the rig to accommodate these requirements. The operator must also consider the visual impact of the project by carefully selecting sites for pads, operations and facilities.

It is the responsibility of the operator to continue to monitor readily identifiable localized environmental impacts associated with specific activities that are under the operator's control (DLNR, 1981).

### 3.2 Well Planning

The high costs and geologic uncertainties in Hawaiian geothermal drilling operations necessitate a special focus on well planning. With minimal planning there is a high risk of spending far more than planned on equipment delays, fishing operations, down time, and other mitigation operations. Known and potential risks need to be taken into account during the planning phase. Lost circulation, hole cleaning problems, stuck pipe, large and complex cementing operations, and well control are a few examples of common geothermal drilling issues. Having the proper mitigation measures and contingency plans in place can greatly reduce the amount of time spent waiting on services or equipment.

#### *Objectives*

The main objectives of well planning are to drill safely, to drill a usable well, and to minimize costs. These main objectives should be continually revisited during the planning process to ensure they are considered and implemented.

- **Safety** - The concept of safety must be carefully applied for all workers and activities at the well site and for the public. A blowout prevention strategy (Chapter 5) is a crucial part of safety practices in geothermal drilling (Patterson *et al.*, 1994a). Proper personnel supervision and training are essential to any safety program, and the rules of workplace safety must be clear and understandable to all who may frequent the well site.
- **Well Function** - Geothermal wells have to be capable of conveying and controlling large quantities of fluid and energy, and they are intended to serve this function for the life of the geothermal project (typically planned for 30 years).
- **Reasonable Cost** – The typical cost for drilling a geothermal well is currently about US\$6 million, although wells drilled in Hawaii may incur greater costs due to special transportation and logistical conditions. Competent planning might cost only 1 or 2% of the total cost of a successful well, but can assure a much greater degree of safety and improved well function.

#### 3.2.1 Well Design

Consideration of the following should be assessed prior to and during the development of a well design for a given project:

- Purpose of the drilling operation – exploration, production, injection, or work-over.
- Reservoir conditions – temperature and pressure logs, drilling records from offset wells, and other geophysical information.
- Logistical requirements – schedule, budget, lease terms, and regulatory stipulations.
- Technical requirements – required production rate, casing diameter at production zone, expected depth, available tools or technology (especially for high-temperature service).
- Likely challenges - lost circulation, stuck pipe, twisted-off pipe, corrosion/erosion, tool failure from high temperature.

- Well trajectory – vertical, directional, or multi-leg; depth to kick-off point; degree of well-path control required.
- Casing design – number of strings, depths, diameters, strength, connections, and materials.
- Completion – open-hole or slotted liner; liner design (if required).
- Wellhead design – pressure requirements, expansion spool, welding, testing.

#### *Expected Reservoir Conditions*

Drilling experience in the Puna geothermal field has found certain challenges specific to the area. These include:

- Extreme losses of circulation (particularly in the unstable shallow formations where lost circulation is frequently not cured until the surface casing is set).
- Hyaloclastite zones that release large amounts of fill into the hole in the deeper zones, causing stuck drill pipe.
- Bottom-hole temperatures in excess of 500°F.
- A lack of local drilling services and infrastructure.

Specific methods have been developed by the operators at Puna over the years to mitigate drilling and completion challenges (Spielman *et al.*, 2006). For example:

- The surface hole is typically drilled blind (i.e., without circulation of drilling fluids to the surface) because there are extreme losses of drilling fluids to the formation.
- Returns of cement to the surface during primary cement jobs are not expected; instead, top jobs are performed using mixtures of rock and ready-mix, in order to get the cement to surface.
- For the intermediate and production casings, foamed cement is preferred due to its higher strength and its tendency to be less likely to crack than conventional cement when exposed to thermal stress.

In contrast to the drilling environment, the water chemistry of the Puna reservoir is not particularly unusual, presenting pH-neutral sodium-chloride brine with variable total salinity in the range of geothermal waters elsewhere, and elevated silica (SiO<sub>2</sub>) due to high temperature (the silica presents some scaling potential on cooling). Table 3.3 compares the chemical characteristics of one sample of reservoir water at Puna to other geothermal systems worldwide, and Section 3.6.2 discusses scaling and corrosion with respect to well design and production issues.

#### *Targets*

Siting of new wells considers all the available scientific data from surface investigations and from existing wells. The goal is for the wells to intersect fractures, stratigraphic contacts between lava beds, open lava tubes, or other permeable structures in order to extract fluids of sufficient temperature at high flow rates. Wells in Hawaii may be drilled vertically or directionally. Directional drilling can reduce both environmental and economic costs by allowing multiple wells to be drilled from a single well pad.

### 3.2.2 Geothermal Well Types

Geothermal wells are commonly classified into three types based on their diameter and intended function: temperature-gradient holes, slim holes, and full-diameter wells. Figure 3.3 shows an idealized diagram of the relation of these three types of wells to the geothermal reservoir. The following descriptions of the three well types are based on industry averages and experience.

#### *Temperature-Gradient Holes (TG Holes)*

This is the first type of well drilled at many (not all) projects. TG holes are intended to delineate the subsurface heat anomaly and to determine the temperature gradient in formations above the reservoir. They are not intended to penetrate the reservoir itself. The diameter of TG holes is small (typically in the range of 1 to 5-inches), and the wells can be drilled with light truck-mounted rotary or coring rigs (Figure 3.4). Typical depths of TG holes range up to 1,000 feet.

TG hole completions are quite basic, typically comprising a surface conductor pipe and a small-diameter tube (metal or plastic) running from surface to bottom. The annulus between the tube and the wellbore wall is typically filled with cement or heavy drilling mud. The inside of the tube is then filled with water, and a valve is put into place at the surface to prevent vandalism and allow access for surveying tools.

TG holes are relatively inexpensive to drill, with small equipment needs (locally-available water rigs), little surface equipment, simple temperature-logging equipment, and simple abandonment operations after the holes have served their purpose. With uncommon exceptions, they do not need blowout prevention.

While a TG hole allows collecting near-surface lithologic samples and temperature data, its small diameter and shallow depth preclude it from being used for production.

#### *Slim Holes*

A slim hole (or slim well) is larger than a TG hole, but smaller in diameter than a full-diameter production or injection well (Figure 3.5). The typical bottom-hole diameter is 4 to 6 inches (the smallest diameter of a production/injection well typically being 8-1/2-inches). A blowout prevention (BOP) stack is nearly always required for the drilling, and a permanent wellhead with a master valve is installed. Some slim holes can be drilled using a large, truck-mounted drilling rig (rotary or core) whereas others are drilled with a medium-sized, track-mounted rotary rig (Figure 3.6).

Slim holes are designed to be drilled into the top of the reservoir to test the viability of the resource. If previous exploration efforts or previously drilled wells have located the depth of the reservoir, this would determine the depth of the slim hole. On average, most slim holes world-wide tend to bottom at 1,500 to 5,000 feet below surface. Most are drilled vertical but deviation is possible (see Section 3.6.3).

Slim holes allow for collecting lithologic and structural data, temperature-gradient information, reservoir temperature and pressure, and other data that can be collected using geophysical logs. Some slim holes can be made to flow, in which case some information about other reservoir properties can be obtained, including fluids chemistry. For various reasons, other slim holes will not flow, but can be tested on injection to obtain some of the same reservoir property information.

Well completions for slim holes are more complex and expensive than TG holes, but in the range of 30% to 50% less expensive than full-diameter wells. A recent comparison of costs and advantages associated with drilling a slim hole versus a full-diameter well is presented in Table 3.4 (Tuttle *et al.*, 2010).

A typical slim hole is drilled with a rotary rig and completed with a surface conductor and a set of casing strings that become narrower with depth. The number of strings is determined by the depth of the hole and the number of diameter intervals. For example, if a slim-hole is drilled in 3 intervals (with top-hole diameter 11 inches, intermediate diameter 8-1/2 inches and bottom-hole diameter 6 inches), a 9-5/8-inch conductor casing would be set, followed by a 7-inch casing and then a 5-inch production casing. All three casings run from the surface to just above the currently-drilled depth, and are cemented back to surface before drilling proceeds. Finally, below the production casing, the hole is open or occasionally fitted with a slotted liner if unstable.

If drilled with a coring rig, a slim hole is usually completed using either HQ (approximately 4-inch) or NQ (approximately 3-inch) drill pipe and coring bit. Up to the completion depth the hole has been drilled in stages with reducing diameter, and the HQ or NQ drill string and bit are finally left in the completed hole to prevent collapse, near the bottom. The intermediate and final stages may or may not be cased back to the surface, but casing a core hole requires special hole-opening operations that can be expensive (see Section 3.6.1.)

Core samples provide information on the geology at depth, including fault and/or fracture locations, formation/mineralogical identification and characterization of hydrothermal alteration in the rocks. Core holes therefore are geologically advantageous but in some geological settings they can be difficult to drill.

A slim hole has a smaller footprint than a full-diameter well, since it typically uses a smaller rig and less complicated equipment and services than a full-diameter well. Slim-hole rigs are highly portable, require minimal support equipment, can be easily moved (some even by helicopter) and are rigged up in one or two days. This is advantageous in environmentally sensitive and remote areas. The slim hole also provides a dual use as a potential injection well or as an observation well.

Further discussion of the equipment for drilling especially deep slim holes is presented in Section 3.6.3.

Three slim holes were drilled by the Hawaii Natural Energy Institute (HNEI) as a part of the Scientific Observation Hole (SOH) Program between 1989 and 1991. Total depths ranged between 5,500 and 6,800 feet (see Table 1.1, Section 1.2 and further information in Section 3.6.1).

#### *Full-diameter Wells*

Any well intended for production from a geothermal reservoir (during either exploration or development of a project) needs to be drilled as a full-diameter well in order to be able to produce large volumes of hot water and steam (Figure 3.7). Because it is often not known whether a given well will ultimately be used for production or injection (and indeed, some producers are converted to injectors and *vice versa* as field management strategies evolve), most injectors also have full-diameter completions.

Full-diameter wells are designed to have a certain number of fully-cemented casing strings, the number of which is dependent upon the planned total depth, the lithological and structural conditions expected, and the planned well course.



Some full-diameter wells are drilled vertically to bottom, whereas others are deviated starting from a “kick-off” point down-hole and drilled directionally thereafter.

The well is drilled with an oilfield-type rig that is capable of large-diameter holes, handling heavy casing strings and adapted with materials and tools that are rated for high temperatures. These rigs have a large footprint and high visibility due to:

- A tall substructure required to provide clearance for BOP equipment beneath the rig floor.
- Large-capacity drilling fluid pumps (“mud pumps”).
- Large storage tanks or pits to hold a reserve quantity of drilling fluid (“makeup” mud).
- A tall, high-capacity derrick with a hoisting system that can pull heavy loads.
- A large rotary table or master bushing to accommodate the larger derrick and allow for adequate handling of large-diameter tools, casing and drill pipe.

Full-diameter well completions are the most complex and expensive. A large conductor (commonly 30-inch diameter) is cemented into place within 100 feet of the surface. Three to four subsequent boreholes of increasingly narrow diameter are then drilled. After each individual section is drilled, the appropriate casing is cemented into place before proceeding to the next smaller section of the well. Figure 3.8 shows a recent full-diameter well completion in the Puna geothermal field (Spielman *et al.*, 2006), further detail regarding casing programs is presented in Section 3.3 and Chapter 4 is dedicated entirely to casing and cementing.

### 3.3 Drilling Programs

The drilling program is the most important and fundamental document in a Geothermal Drilling and Well Modification Permit Application presented to the DLNR. Each proposed geothermal well requires a drilling program that is specific to the known and predicted circumstances at the selected drill site. Regardless of the geothermal well type, the drilling program is the specific technical document that should reflect the best thinking on how the well can be safely constructed and how its intended function can be achieved at a reasonable cost. Safety is considered on a broad front in a carefully prepared drilling plan.

The drilling program is to be prepared by the operator with professional expertise after completing a careful process of well planning, as discussed in Section 3.2. The operator, as the applicant for the Drilling Permit, is exclusively responsible for the drilling program. While the format and details are selected by the operator, the drilling program must contain the essential information that will allow the DLNR to make an informed analysis of the application and a decision for approval or disapproval. The drilling program should be supplemented as needed by tables, figures, and other details; however, the document should be clear and concise in its content, sequence, and proposed procedures. The drilling program is submitted with other requirements of the Application, as discussed in Section 2.2.2.

After drilling operations start, the drilling program is the baseline for all additions or changes that may be forced by the actual conditions encountered down-hole. Both operators and regulators are aware that the conditions encountered may modify or largely preclude the execution of any drilling program, even when the program has been carefully prepared on the basis of competent geothermal well planning. However,

the better the quality of work behind each drilling program, the better it will allow upset conditions to be addressed, should they occur.

### *Program Content*

A comprehensive drilling program should include details on the following:

- Section-by-section procedures, including:
  - Drilled-hole sizes and projected depths;
  - The drilling fluid selected for each wellbore segment;
  - Drilling monitoring procedures for each wellbore segment, including proposed logs;
  - Casing specifications and cementing procedures for each wellbore segment;
  - Testing in each wellbore segment;
  - The completion interval and liner.
- Casing and cementing program (see also Chapter 4).
- Drilling fluids program.
- Directional program.
- Blowout prevention equipment, procedures and strategy (see Chapter 5).
- Vendors list.
- Well logging.
- Geological sampling.
- Drilling data acquisition.
- Testing procedures.
- Communications, procurement, EHS (environmental, health, and safety) program.

This should be a sequential, numbered presentation of the key procedures required to drill the well. Commonly, the program is divided into sections based on the depth intervals related to the surface, intermediate, production drilling and casing stages, followed by a section on completion and testing operations. Operators have differing preferred formats and depth-of-detail in their program contents and this is acceptable but the program should be clear and logically presented.

To provide a ready reference to the well construction, the drilling program should be illustrated by a graphic diagram showing a complete section of the well, which presents hole sizes, casing, and liner configuration from the surface to total depth.

See Appendix D for a generic outline of a drilling program.

### *Casing and Cementing Programs*

Selection of casing sizes starts with determining the desired bottom-hole diameter and the expected depth of the targeted reservoir. These parameters determine the hole sizes and casing sizes for the entire wellbore, including the conductor pipe, the surface casing, the intermediate casing (possibly more than one diameter) and casing that is to be set just above the reservoir (often referred to as “production casing” even if the well is used for injection).

Recent full-diameter wells at the PGV have been completed with a 30-inch conductor pipe, 22-inch surface casing, 16-inch intermediate casing and 11-3/4-inch production casing (Spielman *et al.*, 2006). Earlier wells in the KERZ had smaller casing diameters, and for many geothermal projects elsewhere in the world, it is common to use 20-inch surface casing, with 13-3/8-inch production casing or a combination of 13-3/8-inch intermediate casing and 9-5/8-inch production casing. In addition to requiring mechanical integrity and suitability for intended flow rates, the casing availability and logistics of transportation of all casing and equipment to Hawaii are important considerations. Casing and cementing procedures and specifications are further detailed in Chapter 4.

The casing for a geothermal project can range from 20 to 30 % of the total well cost (Hossein-Pourazad, 2005). Any failure of the casing string leads to loss of the well, or at least a large cost to re-establish the well for safe production or injection. The best available data on local subsurface conditions (including geology, hydrology, pressure profiles, temperature profiles, and fracture gradient) should be taken into consideration in order to ensure safe drilling and high-quality completions. The subsurface conditions and well site elevation are unique to each intended wellbore, and the proposed casing and cement program must reflect a reasonable response to those conditions.

The depth of the production casing is affected by a need to protect groundwater in zones above the reservoir, as well as the need to keep cooler water in shallower zones from entering the wellbore. The casing depth must also be chosen so as to avoid excessive pressures that might cause unwanted fracturing of the formation. The minimum safe casing depth is typically determined by the pressure and temperature expected in the well. For high-temperature resources where no actual data are available, it is often assumed that the temperature and pressure at depth follow the boiling point curve (Figure 3.9).

Well design considerations need to account for the types and grades of casing to be used. The results of any chemical analyses of reservoir fluids should be used to select casing that is appropriate for the potential corrosion and scaling conditions (see Section 3.6.2). For higher-temperature reservoirs, considerations need to be made for the structural and strength allowances of the grade of material to allow for thermal expansion and contraction.

API (American Petroleum Institute) casing specifications provide no minimum strength requirements at elevated temperatures, but tensile properties in cold conditions for various API grades of casing are discussed further in Section 4.3.1, and strength specifications are provided in Table 4.2.

### 3.4 Drilling Fluids

#### *Introduction*

Drilling fluid is a necessary component of the drilling system. This section provides a general introduction to the topic whereas specific reference to drilling in Hawaii is made in Section 5.5.

The purpose of drilling fluid is to remove the cuttings from the bottom of the hole, to cool and lubricate the drill string, to cool the wellbore during drilling operations, to control formation pressure, and to maintain wellbore integrity (Ngugi, 2008).

Additional functions of drilling fluid are to:

- Bring the cuttings to the surface.
- Minimize formation damage.
- Assist in well-logging operations.
- Minimize corrosion of the drill string and casing.
- Minimize contamination problems.
- Minimize torque, drag, and stuck pipe.
- Improve the rate of penetration (ROP).

Many drilling fluids contain bentonite mud as a component and are commonly referred-to simply as “mud.”

The selected drilling fluid is pumped down-hole through the drill string and drill bit, from where it circulates up the annulus of the wellbore (outside of the drill string) back to the surface (Figure 3.10). The fluid design and maintenance program requires a repetitive series of operations and processes to maintain the ideal fluid properties and conditions, which are affected by various surface and down-hole conditions (temperature and pressure, the rock being drilled, mixing with formation water, *etc.*). Changes of these conditions can alter the properties of the fluid, including chemistry, viscosity, and weight (density). Several important drilling-fluid properties are shown in Table 3.5.

Poor design and control of drilling fluid properties can contribute to drilling problems, such as stuck pipe, poor completions, and inadequate logs, and may contribute to low productivity of the well upon completion (due to “formation damage”). An effective drilling fluid should be maintained throughout the drilling of the well, and this is achieved by altering the drilling properties as the wellbore is advanced. Drilling-fluid management and the design of appropriate procedures for expected conditions can yield substantial efficiencies during drilling.

Drilling fluid compositions vary widely, but they are generally water-based and can include: (a) fresh water muds with little or no treatment; (b) treated muds without calcium compounds (*e.g.*, phosphate muds, organic treated muds [lignite, chrome-lignosulfonate, *etc.*]); and (c) muds treated with calcium (*e.g.*, lime, calcium chloride, gypsum). The drilling program should contain the proposed drilling fluids to be used for each section of the well and their associated properties. Table 3.6 shows a template design

for developing a proposed program of drilling fluids and the various properties that would need to be defined for each section of the well.

The first (upper) sections of a well are typically drilled with a simple drilling mud composed of water and bentonite clay, with minor amounts of caustic soda added to maintain a required pH. As the depth of the well increases, temperatures and pressures also increase and affect the properties of the mud, so dispersants are added to control viscosity.

The lower section of the well (where production zones are expected) is typically drilled with water, and once circulation has been lost (when the water leaks off into permeable zones), drilling continues “blind” (*i.e.*, water is circulated down hole to maintain wellbore conditions and equipment, but it does not circulate back to surface). Periodically, a polymer is added to the injected water (creating a “polymer sweep”) to clean the hole of cuttings that are not washed away into the formation by the lost water itself.

Numerous other drilling fluids are used in special situations. Aerated drilling fluids are sometimes employed when drilling the production zones, as this reduces the density of the drilling fluid and allows for continuation of fluid circulation and the return of cuttings to the surface in spite of higher formation permeability. A surfactant can be added to the aerated drilling fluid to increase the viscosity and lifting ability of the mixture (“foam” drilling). In steam reservoirs (*e.g.* The Geysers in California), reservoir zones may be drilled simply with compressed air (“dust” drilling).

### 3.5 Drilling Monitoring

This section provides a general introduction to the topic, whereas monitoring that is specific to well control (blowouts) and experience in Hawaii in the KERZ is in Section 5.6.

Mechanical, hydraulic, and engineering data are continually measured during drilling to balance formation fluid pressures, optimize the drilling process, and maintain a safe operating environment. Monitoring procedures are usually integrated into the drilling program at many points, and careful monitoring is quite important as an effective method to reduce the risk of blowouts.

Specialized sensors located on the rig floor can measure parameters such as drilling speed, drill string rotation, hook load, rate-of-penetration (ROP), drilling depth, pump strokes, and mud weight. Additional sensors monitor mud-pit volume, mud flow rate, and mud gas level, and yet additional ones may be placed in the flow line (an outlet to the sump located above the BOP and master valve), in the choke line (an outlet from below the BOP and master valve that allows some flow to reduce pressure if the well is shut-in at high pressure) and the kill line (an inlet below the BOP and master valve that allows cold fluids to be pumped down-hole while the well is shut-in) and on the cement unit that is used during casing the well (Schlumberger, 2014d).

Surface data systems process signals from the various sensors allow the data to be displayed versus both time and depth at any location on the rig and well-pad office or even sent to remote displays via the internet. Electronic records of the data can be kept, and the compiled data are also documented on paper (and/or computer screen) in mud logs and drilling logs, which are produced in customized formats and scales, daily or on request, providing a record of drilling activity.

Further details on the record and reporting requirements in the State of Hawaii can be found in Section 7.2.

### 3.6 Special Considerations

#### 3.6.1 Cost

##### *Slim-Hole Drilling and the Scientific Observation Hole (SOH) Program*

The high costs of geothermal drilling operations in Hawaii are a valid reason for evaluating slim-hole drilling options for both exploratory and development objectives. Many operators, regulators, and reservoir engineers believe that it is better to invest in a more producible borehole instead of the slim-hole option. However, for initial exploration in new areas, the slim hole allows a relatively low-cost confirmation of the prospective target. If the conditions are proven favorable, a subsequent full-diameter exploration well could be more confidently designed to test the target at much lower risk and costs. Table 3.4 provides a comparison of the typical project specifications, capacities and associated average cost differences between a slim hole and a full-diameter well.

As already noted in Sections 1.2 and 3.2., slim holes were drilled in the KERZ for the Scientific Observation Hole (SOH) Program. Three SOHs reached total depths between 5,500 and 6,800 feet with HQ (nearly 4 inch diameter) core holes. Excellent core recovery and high borehole temperature profiles were measured in the deep prospective zones (see Table 1.1 for SOH well notes).

Due to environmental considerations and regulatory constraints, the original SOH drilling program was modified significantly. This involved changes to the well design and the type and capacity of the drilling rig to be contracted. Hole diameters, casing programs and well-control equipment were re-designed to accommodate statutory regulations and constraints imposed after mediation sessions were held on the Island of Hawaii between the SOH project management and concerned parties.

An objective of the SOH program was to core drill continuously from surface to total depth. However, by the conclusion of the third SOH well (SOH 2), large cost over-runs had been incurred, especially during upper-hole coring and hole-enlargement operations. To protect shallow aquifers, adequate casing was required in the upper portions of the well, but a coring rig cannot drill a hole of adequate diameter for inserting and cementing casing without widening the hole after it is first cored. The “hole-opening” operation was slow and inefficient, imposing severe cost and time penalties on the program.

For operators choosing to drill slim holes in the future in Hawaii, the holes should be rotary-drilled (rather than cored), with the clear objective of obtaining information for the investigation and assessment of the reservoir at depth. This would allow for a larger hole size than a coring rig can drill, while still providing valuable cuttings for assessing the stratigraphic and mineralogical composition of formations above the reservoir.

#### 3.6.2 Formation Fluids Chemistry

Aspects of formation fluids chemistry at Puna that can cause scaling and corrosion and therefore affect well (casing) design, surface facilities design and power production are as follows. There is no way to know how same kinds of issues will affect projects in other areas until they are drilled and tested.

### *Scaling*

Silica is the most common mineral scale that occurs in Hawaiian geothermal facilities. The solubility of silica mineral quartz typically controls the concentration of SiO<sub>2</sub> in reservoir waters, and over-saturation caused by boiling can lead to slow quartz deposition down-hole. The higher levels of SiO<sub>2</sub> that develop with further boiling and cooling can then lead to over-saturation of amorphous silica, as illustrated for the resource at Puna in Figure 3.11. This shows the brine of well KS-10 in the reservoir and at process conditions relative to the solubilities of quartz and of amorphous silica. Production from KS-10 dropped significantly in the early 2000s due to down-hole scaling and the well had to be re-drilled (Spielman *et al.*, 2006). At steam discharge pressure, the KS-10 brine was over-saturated with respect to amorphous silica by about 235 ppm (mg/kg) SiO<sub>2</sub> (GeothermEx, 1994). This was enough to cause a build-up of scale in the separator at the surface, which required periodic mechanical clean-out. Since PGV injection water was a mixture of the KS-10 brine with power-plant steam condensate, the PGV injection water was well-under-saturated with amorphous SiO<sub>2</sub>, and it presented no potential for scaling in the injection wells.

### *Corrosion*

There is potential for corrosion of well casings and the surface system caused by sulfide stress-cracking, by low pH, and by oxygen entering flow lines during maintenance. Oxidized H<sub>2</sub>S also presents a significant acid corrosion potential and so the condenser and injection system should be well-sealed and maintained at positive pressure at all times to avoid intrusion of oxygen from the atmosphere.

There is a tendency towards low pH in volcanic geothermal environments and early records from the Puna geothermal field showed well fluid pHs measured as low as 3.8 in KS-1A and 3.4 in KS-3 (GeothermEx, 1994). In 1991, during the drilling of KS-7 and KS-8 (which experienced blowouts) it was observed that the pH of the production fluid was around 4.5 and this implied that acidic reservoir fluids were encountered.

Corrosive gases (such as CO<sub>2</sub> and H<sub>2</sub>S), when combined with water at high temperature regimes of up to 660°F (about 350°C) can also result in damaged well-bore casings. PGV has therefore monitored certain fluids sample indicators that are diagnostic of scale and corrosion (*e.g.*, Fe, Mn, Na, Cl, Ca, SiO<sub>2</sub>, TDS, pH), and future projects should do so as well.

### *Choice of Casing Materials*

All casings and well structures used down-hole should be selected to withstand the corrosive effects of the reservoir fluids. For example, steel with 1% chrome can provide enhanced corrosion resistance, while adding 0.5% molybdenum decreases steel degradation at high temperatures (Spielman, *et al.*, 2006). Casing weight, grade and joint threads should be sized for tension, burst, and collapse pressures. According to the 1994 DLNR drilling guide, common safety factors in use are 1.125 for collapse, 1.50 for burst and 1.75 for tension (Patterson *et al.*, 1994b); these safety factors are still considered valid.

### 3.6.3 Equipment

#### *Deep slim hole drilling operations*

For deep slim holes (on the order of 5,000 to 8,000 feet), the drilling equipment required is similar to the equipment used to drill full-diameter wells. Still, there may be cost savings from even deep slim holes

relative to full-diameter wells, because they are designed to drill with smaller-diameter tri-cone bits and a bottom-hole assembly (BHA) of lesser diameter, resulting in a higher rate of penetration and less overall drilling time. Typically, the drilling rig for shallower slim holes is a truck-mounted rig that may have some of the ancillary equipment already incorporated in the truck (mast, rotary table, controls, pipe-handling system, air compressors, pumps, etc.). This facilitates the mobilization of the equipment and cuts down the time to rig up.

The rig's engines should be properly matched for the depth that is intended to be drilled. Attempting to save cost by using a rig of smaller capacity than what is required normally ends in the opposite effect; that is, higher costs due to slow drilling, or having to complete the well before reaching the intended target.

Since the slim hole casing diameter is smaller than casing in a production well, the BOP equipment used for slim holes is also smaller and easier to install; however, it has to have the same characteristics as the larger equipment with respect to pressure rating and closing elements (pipe and blind rams, annular rams, *etc.*), and it must still conform to API RP 53. The need to accommodate the BOP equipment below the rig floor can require that the driller supply a ramp to elevate the rig above ground level, in order to fit the BOP equipment within the cellar and the space below the rotary table.

It is also important that the rig chosen for drilling the slim holes have sufficient pump capacity to maintain the hole clean. The hydraulic design in the smaller-diameter hole and the smaller-diameter drilling tools should require smaller pumps than those used in full-diameter wells; however, a minimum of two identical pumps should be present with the rig, and they should be connected in a way that allows them to be combined if needed.

The smaller footprint of the slim-hole drilling rig requires less pad area and less civil works for the pad and the access roads. This characteristic facilitates the permitting process because the damage caused to the environment is less.

Just like full-diameter wells, slim holes can be drilled directionally, which is a great advantage because the rental of the smaller directional tools (mud motors, steering tools, etc.) is less expensive and requires less mud flow to move them, thus, saving in pumping fuel and daily rental costs.

The hoisting capacity requirement for a slim-hole drilling rig is normally much less than that of a rig for full-diameter drilling, since the bottom-hole assembly used to drill the hole is less heavy. The smaller capacity demand translates into lower fuel usage per day.

Cementing of casing into a slim hole is preferably conducted using services from a reputable cementing company. The only immediate savings obtained from this are less use of cement volume to be pumped, but the lifetime of the well and the proper sealing of the formations are better-guaranteed.

The drilling mud utilized to drill a slim hole has to be also of good quality, in order to guarantee proper wellbore cleanout and hole stability. Using the proper mud and additives to keep up the rheological properties of the mud in the presence of high temperatures is very important to reduce the risk of getting the drill string stuck. The savings in drilling mud come from the smaller quantity of mud used in the system during normal drilling.



### *Transportation from Outside Hawaii*

Hawaii is located approximately 2,400 miles from North America, the nearest continent, and is considered a remote location for drilling equipment transportation. All materials and equipment must be on location to initiate a project, or drilling can be delayed a week or more waiting for shipments from the mainland. For example, when drilling Puna well KS-6, cracks were discovered in the hook and new blocks had to be air freighted from Houston to Hawaii (Spielman *et al.*, 2006).

#### 3.6.4 Tolerance on Vertical Wells

For both full-diameter wells and slim holes, it is important to maintain the well's verticality in the upper section, even if the lower portion of the well is to be directionally drilled. If a well is intended to be vertical throughout, a small deviation in verticality in the upper section could result in a significant horizontal displacement at the bottom of the well. Likewise, a directional well that is kicked-off from a non-vertical section requires running a complicated directional log in order to know the exact position of the kick-off point, and thereafter, of the subsequent directional wellbore. Since most of the time the upper vertical section is cased off, it is not possible to use magnetic directional tools, and running an expensive gyroscopic log is necessary. The verticality should not exceed a tolerance of 1 degree per 300 feet, with a maximum total deviation in the whole drilled interval of 3 degrees. Vertical wells located in very small concession areas are particularly problematic when these deviation tolerances are not respected, because it becomes more critical to keep the desired separation from the property boundary.

#### 3.6.5 Natural Hazards

The KERZ is a tectonically and volcanically active area extending eastward from Kilauea Caldera. Young rift zones on Hawaii, extending from the principal volcanoes, are active seismically and form the locus of eruptions of lava flows. Earthquakes accompany the filling of the principal volcanic center with new magma from depth. Magma then may move laterally outward into the rifts and flanks; in the case of Kilauea, southward and eastward into the KERZ or southward into the Kilauea South West Rift Zone (KSWRZ), a comparable rift feature on the other side of the volcano. The rift zone widens as it undergoes intrusion, and additional earthquakes mark the vertical movement of magma into dikes. Eruptions may follow through fissures along the rift, and from cones.

#### *Volcanic Eruptions*

Flows of lava from a few feet to tens of feet in thickness are erupted from the cones and fissures, and normally flow toward the coast. Eruptions frequently develop a lava-tube system and lava flows downslope through the tubes, emerging at the coast. The lava moves at varying velocities, although often as a viscous mass with a blocky front. Such events have occurred repeatedly during the last century all along the Puna Coast; more than 10% of the land surface is comprised of flows less than 100 years old (see Section 1.1).

Historically, volcanic activity has been uniformly distributed along the entire length of the KERZ. However, during the past 30 years, activity has been concentrated in the upper and lower KERZ. There is, therefore, a distinct possibility that a geothermal wellfield and power plant could be affected by flows of lava or by the eruption of a cinder cone. However, given the uncertain periodicity of volcanic eruptions, the great length of the KERZ, and the local control exerted by topography on flow direction, it

becomes impossible to predict whether a specific site will be free of damage. Probabilities of risk or damage can be estimated, based on history, topography, and assumptions regarding magma-generation rates, and rates of rift expansion and dike intrusion into the KERZ.

Considering these concerns, the USGS has developed a series of Lava Flow Hazard Zone Maps, delineating and ranking the volcanic hazards on the Island of Hawaii. These maps are available online at <http://pubs.usgs.gov/gip/hazards/maps.html>.

Careful consideration of the elevation of potential well sites and the probable lava flow courses in the topography should be taken, with naturally elevated drill sites and well pads offering the most effective offset in the event of surface lava flows in the project area. For long-term protection of well sites, large berms of volcanic cinder can be placed around well pads to establish an effective barrier for stopping lava flows by cooling and solidifying the first-arriving lava front. A summary of the surface hazards that accompany Hawaii's active volcanism is presented in Mullineaux *et al.* (1987).

### *Earthquakes*

The KERZ is continuously active seismically. However, the overwhelming majority of earthquakes are below the threshold of recognition by humans, and most of the remainder have little potential to cause damage.

Several kinds of seismic events occur along the rift: shallow-focus events with episodic frequency related to volcanism and magmatic movement; deeper-focus events (approximately 6 miles deep) related to tectonic movement along major faults as the south side of the rift zone slips downward; and smaller seismic events believed to be related to the movement along smaller faults within the rift zone. There is also seismic risk associated with the Hilina fault system, located south of the Kilauea rift zones; the last large-magnitude event on the Hilina fault (magnitude 7.2) occurred in 1975 (Figure 3.12).

In 2006, the Puna Borehole Network was established in the Lower East Rift Zone (LERZ) to provide detailed seismic data on the Puna geothermal field. While this data is intended to be used to identify fault and dike trends and structures at depth in the area, it will also provide valuable data in terms of volcanic hazard monitoring (Kenedi *et al.*, 2010).

Seismic risks can be mitigated by building permanent structures in accordance with the seismic safety criteria of the pertinent Hawaiian construction codes, and should be designed to withstand the maximum recorded ground acceleration in the Island of Hawaii.

## 4. CASING AND CEMENTING

### SUMMARY

- 4.1 Introduction: Importance of proper wellbore cementing, casing design, and planning.
- 4.2 Regulations: References and basis for cementing and casing requirements.
- 4.3 Casing and Cementing Programs: Components, best practices, and objectives of casing and cementing programs.
  - 4.3.1 Casing: Important casing program considerations, including casing profiles, materials, depths, and special casing issues in Hawaii.
  - 4.3.2 Cementing: Important cementing procedures, mud and free-water issues, pumping materials and methods, slurry components, cement types and additives.
- 4.4 Other Special Considerations: Specifics issues related to geothermal casing and cementing in Hawaii.
  - 4.4.1 Lost Circulation Zones (LCZs): Control and mitigation of loss zones while cementing.
  - 4.4.2 Top Jobs and Backfills: Methods for completing fallback cement jobs.
  - 4.4.3 Sacrificial Liners: Applications and uses of protective liners.
  - 4.4.4 Strength at High Temperatures: Materials selection considerations.
  - 4.4.5 Casing Availability: Transportation and project timeline considerations.
  - 4.4.6 Fluid Chemistry: Effects of fluids and considerations for mitigating corrosion and scaling.

#### 4.1 Introduction

This chapter treats in detail an important topic that was introduced in Chapter 3.

As previously noted, casing and cementing programs are used to establish the proper planning and design of the wellbore and its completion in a manner that minimizes or eliminates the risk of failure. When a well is drilled to depths of more than a few hundred feet, conventional practice is to set successive, separate strings of casing as the well gets deeper, with the length of each string, cementing procedures and materials chosen (casing, cement) determined by various factors many of which are listed below.

The casing and cementing design depends in part on the intended use of the well. However, most of the program should be based on a thorough evaluation of the best available subsurface data concerning (but not limited to):

- Formation and rock properties (hardness, fracture orientation and intensity, tendency to slough or swell, formation-failure threshold or “fracture gradient”).
- Hydrology (especially shallow aquifers that must be sealed off).
- The formation fluids (pore pressure, chemistry and temperature, pressure and temperature profiles).
- The maximum expected pressures and temperatures that will be applied at the wellhead, considering among other factors the pressures of the most permeable formation or production zone(s) down-hole. When these pressure parameters are not yet known, other relevant wellbore pressure and temperature data can be used to calculate comparable minimum thresholds (Standards New Zealand, 1991).
- The well-site elevation, planned well trajectory, expected reservoir depth and regulatory requirements.

The incorporation of known and expected conditions at depth, even if uncertain, establishes a solid foundation for safety in drilling and quality of construction. The subsurface conditions are unique to each intended wellbore and the proposed casing and cement program must reflect a reasonable response to these conditions.

This said, the design of a geothermal well is a typically “bottom-up” process (Finger and Blankenship, 2010). The expected depth and location of the production zone and the likely (approximate) flow rate will determine the wellbore geometry and casing program. Because flow rate depends upon both reservoir properties and well properties, there also exists an economic trade-off in selecting the diameter of the deepest part of the well. For example, a wider diameter potentially allows a higher flow rate, costs more to achieve, but may allow drilling fewer wells.

The well is then designed to have successively larger casing diameters from the production casing or liner at the bottom of the well up to the surface. During drilling and casing operations, the geologic properties and actual drilling experience are taken into consideration when selecting the exact depth for each casing and the cement additives that should be used (within tolerances prescribed by the drilling program developed for the project; see Section 3.3).

Some lower-temperature geothermal wells will not self-flow and must be pumped, or will not flow at optimal rates without being pumped. To do this, either a line-shaft pump driven from the surface or a down-hole electric submersible pump (ESP) can be used, and the diameter of the smallest casing cemented back to surface must allow for installing the down-hole pumping equipment.

Considering the nature of the resource and utilization requirements, it is important to recognize the following:

- Because each casing string inherently limits the diameters of the drill bit used to continue drilling and the next casing string that can be installed, the hole diameter decreases as the well is deepened.
- Due this progressive reduction in diameter and due to casing costs, it is advantageous to make each well section (between casing points) as long as possible.
- However, problems most often occur while drilling long open-hole wellbore intervals between the casing points.

There is obviously a tension between the last two points: while it is highly desirable to drill long intervals, doing so greatly increases the probability of encountering trouble zones and getting stuck.

#### 4.2 Regulations

As stated in *Hawaii Administrative Rules Title 13, Subtitle 7, Chapter 183 (Water and Land Development: Rules on Leasing and Drilling of Geothermal Resources)* (HAR 13-183), the casing used in all wells should be properly designed and installed to protect and prevent or to minimize damage to the environment, ground water resources, geothermal resources, life, health, and property (DLNR, 1981). The permanent wellhead equipment for each well and all casing strings cemented back to the surface should provide for adequate well-pressure control (including adequate anchorage for blowout prevention equipment), operational safety and protection of all natural resources.

The casing and cementing requirements described below are general and should be used as guidelines in submitting proposed casing programs.

Additional regulations stipulated by HAR 13-183 are included where appropriate below.

#### 4.3 Casing and Cementing Programs

##### *Useful References*

Extensive references to casing and cementing are available, although many are specific to the oil and gas industry and do not consider the special design parameters and changes that are required for high-temperature wells.

These include guidelines from the *Technical Report on Equations and Calculations for Casing, Tubing, and Line Pipe Used as Casing or Tubing* (API, 2008) and the equivalent ISO standard 10400:2007 - *Equations and Calculations for the Properties of Casing, Tubing, Drill Pipe and Line Pipe Used as Casing or Tubing* (ISO, 2007), which provide the equations and information necessary to calculate

various pipe properties including: performance, strength, collapse resistance, assembly force (torque), test pressures, and critical product dimensions.

All drilling engineering textbooks such as the *Petroleum Engineering Handbook, Volume II: Drilling Engineering* (Mitchell, 2007) and *Applied Drilling Engineering* (Bourgoyne *et al.*, 1991) have sections on numerous drilling-related activities, including: well planning, casing and wellhead design, drilling geoscience, drilling fluids and mechanics, bit selection, well control, directional drilling, cementing, drilling problems, and data acquisition and interpretation.

Specific to geothermal drilling is The Code of Practice for Deep Geothermal Wells (Standards New Zealand, 1991), which applies primarily to geothermal wells between 800 and 9,800 feet depth with subsurface temperatures up to about 660°F (350°C). This document covers drilling, operation, maintenance, repair and abandonment of geothermal deep wells, as well as well design, site preparation, drilling equipment, tools, materials and industry practices. It includes all subsurface work, plus the wellhead up to the top flange of the master valve.

Engineering judgment is important in the design stage and it is critical to have a well-trained drilling engineer with geothermal experience review any proposed casing and cementing program.

#### *Casing Program Factors*

Thermal stress on casing and its connections is an important issue. Because the wellbore is cooled during drilling, casing is typically cemented in place at a temperature below the actual surrounding formation temperature. It later heats up over time (during well testing and production); and then it cools down again if the well is shut-in or if subsequent rig work is performed that requires renewed circulation of drilling fluids. This cycle can stress the casing and connectors beyond the yield point. Therefore, the temperature stresses known to exist in the geothermal resources of Hawaii (with reservoir temperatures up to 660+°F) must be taken into consideration when selecting casing.

The effect of these high temperatures on the modulus of elasticity of different grades of steel is significant. The design of casing strings should allow for changes in the casing properties, specifically the tensile yield and ultimate strength. Table 4.1 provides casing strengths that can be used during the well-planning process in the absence of reservoir or well-test temperature data.

If a casing failure occurs, the loss of production and cost of repairs can be significant. The primary intent of the well design process is to eliminate or reduce the risk of such failure and the design and construction techniques used throughout the geothermal industry are continuously refined in an effort to minimize the risk of catastrophic casing failure.

As suggested above, the casing design has a significant impact on well cost. Because most geothermal wells have wide casing diameters (compared to oil and gas wells), the casing for a geothermal project can range from 20 to 30% of the total well cost (Hosseini-Pourazad, 2005) and casing plus cementing costs can reach 40% of total well cost (and occasionally higher). As a result, eliminating one string of casing can yield a total well cost reduction approaching 20%, so long as the well is designed properly for the resource (Finger and Blankenship, 2010). Such potential cost savings must be balanced against any risk of lowering the safety factor of the project, but this emphasizes the importance of close examination of the casing program by well-qualified and trained geothermal engineers.

Additional details concerning the casing program design are presented in Section 4.3.1.

#### *Cementing Program Factors*

The objective of any casing cementing program is to ensure that the total length of annulus (both the annulus between the casing and the open hole, and the annulus between casing strings) is completely filled with sound cement that can withstand long-term exposure to geothermal fluids and temperatures. To achieve this, the cementing program should be designed to use materials, additives, and procedures that will achieve the best possible cementing job, including consideration and mitigation of the following to ensure integrity and longevity:

- Necessary cementing equipment.
- Type of cement material and proper mix of slurry for different temperatures and hole conditions.
- Additives to be mixed into the slurry (based on wellbore conditions and chemistry), including LCZ (lost-circulation zone) materials.
- Type of procedure to be implemented for cementing (multi-stage, reverse circulation, *etc.*).
- Expected volumes of cement needed for each proposed well section.
- Use and placement of centralizers on the casing string.
- Use of the reciprocating technique during cementing.
- Pre-cementing cooling or flushing procedures.
- LCZ or top-job procedures.
- Pressure testing procedures.

Cementing calculation worksheets are typically drafted as a part of the casing and cementing program. These can be adjusted based on the conditions actually encountered down-hole during drilling and the recommendations of the cementing operator prior to implementation. An example of a cementing calculation worksheet is given in Figure 4.1.

Casing is cemented in place by pumping a calculated volume of cement down-hole using one of three general methods that are describe in greater detail in Section 4.3.2:

- Pumping directly into the casing at the surface, placing a movable plug on top of the cement and pumping water or drilling fluid to push the plug and cement downwards and up into the annulus;
- Through open-ended drill pipe or other pipe that is inserted down the casing and connected to a “float collar” that is positioned near the bottom; and
- Using “reverse circulation,” by which the cement is pumped from the surface directly into the annulus to be cemented (Hole, 2008c).

With any of these alternatives, there are additional factors that have to be considered in the cementing program. For example:

- It is important to use light-weight (low density) cement because cement in the annular space is often lost into the formation (a form of “lost circulation”). One solution to this is foam cement. However, even with light-weight cement, it is often impossible to lift a column of cement back to the surface without breaking down the formation, and this can make it necessary to repeat the cementing process at least in part, or to add extra cement into the annulus at the surface.
- The high thermal stresses imposed on the casings demand uniform cementation over the full casing length, ensuring that stress is distributed over the length of the casing uniformly and avoiding areas of concerted stress.
- Uniform cementation is also needed to avoid trapping pockets of water between the cement and the wall of the casing because later, when the well is flowed, the hot well flow will heat up such pockets, creating pressure that can cause a casing collapse.
- The casing and cementing program can be designed to use “stage collars” so that not all of the cementing takes place at once. Stage collars are large connections placed between joints of casing that have ports which can be opened at a specific time to allow cementing in stages, thus reducing the cement pressure on the formation.
- Geothermal wells being typically deep and hot by nature, the additional heat generated by cement hydration may cause a substantial temperature increase in the annulus. This factor must be taken into account in cement slurry design. Temperature and pressure both affect how long the slurry will remain pumpable (how its viscosity changes) and how it develops the strength necessary to support the pipe (how it sets) (Kutasov and Eppelbaum, 2012). Sufficient pumping time and setting time are crucial to provide safe placement in the well and a secure cement job.
- The design of a proper cement slurry and procedure is also crucial for maximum protection from external corrosion, thermal cycling, and mechanical stress, and it should be developed based on the physical characteristics of the resource.
- See yet further detail in Section 4.3.2.

#### 4.3.1 Casing

##### *Casing Profiles (Casing Intervals)*

The general casing profile is developed based on several parameters of the project resource and a typical one for a production well is shown in Figure 4.2. Once the general casing profile is selected, the casing material for each interval of the well is selected. Parameters that determine the casing profile requirements include the following:

- Nominal production rate from the well and the casing diameter implied by that flow rate;
- Depth of the production zone;
- Expected temperature and chemistry of the reservoir fluids;
- Whether the completion will be open-hole or require a slotted liner;



- Well trajectory (vertical, directional, or multi-leg), kick-off point (if directional), the need for special casing material or connections, and the length of individual casing intervals (dependent upon rock properties, formation fluids, surface casing setting depth, etc.).

There are many reasons to set casing in a particular interval and a few of the more common ones are to:

- Protect an aquifer. The regulations set forth in HAR 13-183 require sealing off all groundwater aquifers to prevent their contamination by wellbore or drilling fluids.
- Provide well control in the event of a pressure kick. It must be possible to mitigate the kick safely without exceeding the fracturing pressure at the shoe of the last cemented casing (see Section 5.3.2 for further details).
- Isolate troublesome formations, such as rock that is sloughing, swelling or unconsolidated, zones with high or incurable lost circulation, or a depleted-pressure zone above the production horizon.
- Provide fluid pressure control. This need is more common in oil and gas than it is in geothermal, because geothermal drilling fluids frequently contain additives that raise the specific gravity of the drilling fluid above that of water. The weight of the fluid column is then such that it can control the down-hole pore pressure in the formation.
- Define the production zone. Geothermal reservoirs can have more than one production zone, and casing is sometimes set to allow production from a selected zone or set of zones.

The depth of each casing string should be determined such that the casing and cementing operations will safely contain all well conditions that may occur as a result of operations at the surface, as well as conditions down-hole as a result of changes in the reservoir fluids or formation(s) (Figure 4.3) (Hole, 2008b).

The fluid that flows up the production casing and through the wellhead at different times may be water, saturated steam, superheated steam, cold gas, or some mixture of these, presenting a wide range of temperatures and pressures. The permanent wellhead that is affixed to the well (and most-typically onto the intermediate casing string) must be selected based on all of these and other conditions, including those that may occur as a result of surface operations and changes in the reservoir. It should also conform to API SPEC 6A (API, 2010). A typical wellhead configuration is shown in Figure 4.4 and Figure 4.5 shows how the pressure ratings of the casing heads conforming to API SPEC 6A are de-rated as temperature increases.

The design of the connection between the wellhead and casing tops should additionally ensure protection from both wellbore fluids and the atmosphere to prevent corrosion. This is typically accommodated by preventing accumulation of gas in the wellhead, isolating vulnerable parts with cement, or applying a protective coating of material such as chromium plating or epoxy (Standards, New Zealand, 1991).

### *Casing Materials*

Casing is generally characterized by four basic parameters: diameter, weight, grade and the type of joint thread. Diameter is the nominal outside diameter (OD) of the casing interval (joint couplings are slightly wider). Weight (specified per unit length) is a measure of the wall thickness of the casing; heavier casing has smaller inside diameter, since the outside diameter must conform to a nominal-size. Grade is related

to the material's tensile strength, although there are metallurgical variations designed to withstand certain adverse effects, such as corrosion and sulfide stress cracking (see Section 4.4).

The drilling program specifies these parameters for each casing interval in the well, considering the expected geological, reservoir and production/injection conditions, the down-hole equipment that must later pass through the casing (such as liners, drilling equipment, pumps and logging tools) and sometimes also the trade-offs that may exist between contrasting parameters (such as substituting higher weight for lower grade).

When selecting successive casing diameters, it is important to maintain a minimum of 2-inches diameter difference between the inside of each interval and the outside of the next, smaller-diameter section of casing, in order to ensure adequate space for pumping a satisfactory cement job. For example, following the setting of 13-3/8-inch casing (with a casing wall thickness of 1/3-inch, giving an inside diameter [ID] of 13-1/24-inches), the largest diameter casing that should be run would have an outside diameter just over 11-inches (Figure 4.6).

Selection of casing weight, grade, and joint threads will be based on tension, burst, and collapse pressures. The American Petroleum Institute (API) has standardized several grades of steel that have different chemical content, manufacture processes, and heat treatments, and therefore different mechanical properties. The most common steel casings used in geothermal wells (as specified under API SPEC 5CT) are grades H-40, J-55, K-55, C-75 and L-80 (API, 2011) but T-95, C-90 and other grades are also used. In addition to this, the weights and grades of steel should be selected to obtain maximum resistance to corrosion from the fluids that will be encountered, including the gases CO<sub>2</sub> and H<sub>2</sub>S. Use of other API steel grades should be limited to those that have been tested and approved for use in H<sub>2</sub>S environments, as the resistance to corrosion is dependent upon the steel composition and heat treatment processes during manufacturing (Standards New Zealand, 1991).

Although susceptibility to sulfide stress corrosion decreases at higher temperatures, there is a potential problem in Hawaii with the mechanical integrity of wells that have produced high-temperature fluids and are then shut in for long periods of time. This is because shallow ground water around the upper part of a well can cool the casing and accelerate H<sub>2</sub>S corrosion (both external, if formation H<sub>2</sub>S is leaking up the annulus or via the formation, and internal when H<sub>2</sub>S is present). API casing specifications provide no minimum strength requirements at elevated temperatures, but tensile properties in cold conditions for various API grades of casing are provided in Table 4.2.

Casing also has to endure different kinds of loading, the most common design criteria being for burst pressure, collapse pressure, and axial tension. Burst pressure and axial tensile strength for a given casing size are primarily a function of the casing grade. Collapse pressure is more- directly related to the wall thickness, since susceptibility to collapse is determined by the material's elastic properties and geometry, as well as by its tensile strength (see Table 4.2).

When designing the casing and cementing program, special attention should be given to the effects on casing-strength of high temperatures (Hole, 2008a), which can include:

- A change in the length of un-cemented pipe (*e.g.*, an expected expansion of 6 feet over a length of 3,280 feet [1,000 meters] when temperature rises 300°F).

- A compressive stress change for cemented pipe over the same 300°F rise would be 52,000 psi.
- A reduction in steel strength of approximately 5% (in casing tensile strength tests conducted at 572°F).

Current practice in Hawaii is to use higher casing weights and lower casing grades to obtain the desired strength for collapse, burst, and tension and to resist thermal stress and corrosion. The GS-85SS and T-95 grades have about 1% chrome, which provides corrosion resistance, and about 0.5% molybdenum, which reduces strength degradation at high temperatures (Spielman *et al.*, 2006). Strength at high temperatures is also considered in Section 4.4.4.

The joint threads being used generally are Buttress, Seal-Lock, and VAM (Figure 4.7). Where axial strength is important, casings should be buttress type, as axial failure occurs when the casing string is heavily loaded, and V-shaped threads tend to separate and slip. The buttress-thread casing-joint has proven tensional and compressional strengths (Standards New Zealand, 1991). Premium Hunting Seal Lock connections maximize the compressive strength of the joints to resist failure at high temperatures (Spielman *et al.*, 2006). The Operator must select casing and joint threads only after thorough investigation of recent experience and performance and should always consider new changes in technology in the area of corrosion-resistant steels and premium-thread couplings.

The total weight of the casing string should not exceed 75% of the hook-load capacity of the rig (Tan, 1997).

Another typical specification is that one-third of the hole should be behind casing at any given time during the course of drilling the well (Hosseini-Pourazad, 2005).

Once the minimum required depth is reached, casing should be run unless the formation is incompetent. It is important to have competent rock at the casing shoe, to be able to withstand the high pressure gradient from the pressure test upon cementing the casing, and to be able to drill forward to the desired depth and temperature. Minimization of the potential for a blowout can be achieved by setting the casing in a relatively impermeable and structurally competent formation. If the minimum casing depth is reached and there is no competent rock, common practice is to drill ahead until competent formation is reached.

#### *Casing-Depth Regulations and Recommendations*

- **Conductor casing** – According to HAR 13-183, the minimum conductor casing depth is 50 feet with a maximum of 150 feet (DLNR, 1981). The conductor must be successfully cemented back to the surface.
- **Surface casing** – Surface casing should be cemented below the local groundwater table. Where the groundwater table is within 600-800 feet below surface, an approximate 1,000-foot length of surface casing would meet this objective. According to HAR 13-183, the surface casing must be set to a minimum depth of 10% of the proposed total depth of the well or 500 feet, whichever is greater. If usable basal ground water is present or reasonably suspected to exist in the area, the depth of the surface casing must be approved by the BLNR. Where the groundwater is deeper, as much as 2,000 feet of surface casing may be required.

The surface casing string must be successfully cemented back to the surface. It may be difficult to obtain a good cement sheath on surface casing because of the presence of lost circulation zones and incompetent rock in which to cement the casing shoe. Best practices in drilling suggest it is better to obtain a quality cement sheath on a shorter length of surface casing. Accordingly, HAR 13-183 states that “a second string of surface casing may be required if the first string has not been cemented through a sufficient series of low permeability, competent rock formations or (if) a rapidly increasing thermal gradient or rapidly increasing formation pressures are encountered,” (DLNR, 1981).

For full-diameter geothermal wells, the typical surface casing has a diameter of 20 inches. Recent wells at the PGV project have utilized 22-inch casing cemented in 26-inch open hole at approximately 1,000 feet (Rickard *et al.*, 2011a).

- **Intermediate casing** – An intermediate casing should be set at depths between 1,000 to 2,500 feet below the surface casing shoe if no unexpected geothermal fluids or anomalies are encountered. The intermediate casing-shoe depth should optimally be below the major groundwater body. It should also be below
  - extensive fracture zones that may reach up to the groundwater table;
  - frequent occurrences of lost circulation zones; and
  - incompetent volcanic rock.

The typical intermediate casing string for geothermal wells has a 13-3/8-inch diameter and is set in a 17-1/2-inch hole. Recent wells at PGV have used a 16-inch intermediate casing set in 20-inch hole (and also a wide production casing), which is more expensive but allows higher production rates.

According to HAR 13-183, the intermediate casing string must be successfully cemented back to the surface to protect against anomalous pressure zones, cave-ins, washouts, abnormal temperature zones, uncontrollable LCZs (lost-circulation zones), or other drilling hazards. Because the intermediate casing provides the critical attachment for the complete BOP equipment stack required to drill to total depth, it is critical that the cement sheath in the annulus outside the intermediate casing be of the highest possible quality. The drilling results for the intermediate section of the well should be carefully studied to guide the cementing process. Any adverse down-hole conditions can be mitigated by cementing the bottom portion of the intermediate casing as a liner in the open-hole interval (lapped at least one hundred feet into the bottom of surface casing). The upper portion can then be run and cemented as a tie-back string inside the surface casing.

- **Production casing** – Production casing should be set at depths of approximately 4,000 feet or greater, at the top of the reservoir zone. The typical production casing for geothermal wells has a 9-5/8-inch diameter and is set in 12-1/4-inch hole. Recent wells at PGV have used an 11-3/4-inch production liner set in 14-3/4-inch hole. According to HAR 13-183, production casing may be set above or through the producing or injection zone and cemented above these zones. As with the intermediate string, the production casing should be cemented back to the surface with high-quality cement and with every attempt made to ensure a competent cement sheath between casing

and formation. This cement sheath effectively excludes overlying formation fluids from the production zone and prevents movement of fluids behind the casing into zones above that contain ground water.

Production casing should either be run and cemented solid to the surface or lapped into intermediate casing (if installed). The preferred method is to overlap the intermediate casing by at least 100 feet (even though only 50 feet is required by HAR 13-138) and then run a tie-back string to the surface. As with the intermediate string, hole conditions will dictate whether a tie-back string or stage cementing is desirable. The lap should be cemented and pressure-tested to ensure the integrity of the lap. At the surface, the production casing should be landed in an expansion spool.

- **Liner** – A slotted or perforated liner may be hung in the open hole below the production casing to provide protection against hole collapse or rock debris, but under some reservoir conditions it is possible for open-hole completion intervals to remain intact during flow without liners.

#### *Special considerations*

Drilling reports from publicly available sources reveal several special issues when drilling geothermal wells in the KERZ (Patterson *et al.*, 1994a). Specifically:

- Weak and broken near-surface volcanic rocks are present throughout the KERZ. Where the groundwater table is deeper than expected, it may be difficult to obtain a good cement sheath on the surface casing because lost circulation zones are present and the rock is too incompetent to cement the casing shoe. Recognizing this condition is a precursor to obtaining a reliable casing anchor, which is fundamental to safe blowout prevention with complete shut-off (CSO) of the well.
- Even if a good cement sheath on the surface casing is obtained, there may be fractures or other permeable paths to the surface in the near-surface volcanic rocks, and these rocks may have low fracture gradients. This presents a serious risk in using a complete shut off (CSO) blowout prevention system on the surface casing while drilling to the intermediate casing depth. A CSO could force unexpected hot and possibly pressurized formation fluids to an external blowout (outside the surface casing and cellar). External venting of this type can pose complex and precarious kill operations, and can also threaten the drilling rig's ground support. Accordingly, a diverting capacity installed on the wellhead below the BOP, with a large-diameter flow line that leads to a distant disposal point should be considered, as an alternative to using CSO at this stage of drilling. This approach would contain such an uncontrolled flow inside the surface casing and afford a safer kill procedure confined to the wellbore.
- Finally, it is necessary to decide whether the production interval of the well can be left as open hole or whether a slotted liner will be necessary to protect against sloughing or caving into the wellbore. Some indications can be gained from the geologic samples acquired during drilling, or from imaging logs (if available), but this decision is often made based on experience gained from other wells in the same reservoir, as at the KERZ, where open hole completions have been possible. (This does not mean that all future KERZ wells can omit a liner, as special conditions can always arise.)

### 4.3.2 Cementing

#### *Introduction to Procedures*

When designing the casing and cementing program, all down-hole data and conditions are reviewed and taken into account in specifying the placement techniques, the volume of cement needed, and the cement composition. An example of the expected conditions determined during the well-planning stage compared to the conditions actually encountered during the drilling of PGV well KS-11 is given in Table 4.3 (Bour and Rickard, 2000). Casing is cemented in place by pumping a calculated volume of cement down-hole to fill the annulus between the casing and the formation wall (or between the previously-set larger diameter casing string and the new section of smaller-diameter casing) (Figure 4.8). Cementing operations typically include:

- Correctly placing the needed equipment and tools (*e.g.*, float collar, float shoe, centralizers, displacement plugs, *etc.*).
  - The cementing-services contractor typically supplies all the surface equipment needed for mixing and pumping the cement. The cementing equipment is then hooked up and pressure-tested to ensure it is operational. The cement is typically mixed and pumped from a cement truck that is hooked up directly to the wellhead.
- Mixing the cement slurry and making adjustments with additives based on measurements conducted onsite.
- Cleaning the wellbore of cuttings and wall cake by circulating it clean after running in the casing string.
  - Prior to picking up the last joint of casing to be run, the well is circulated clean to flush any debris or cuttings from the bottom of the hole and to cool the wellbore, which can take several hours. During this cooling period, the mud-viscosity and gel-strength levels in the drilling fluid are brought down to thin the mud and remove wall cake.
- Pumping the cement slurry (as specified by the cementing service contractor's laboratory) – see detail below.
- Determining the height of the cement inside the annulus.
- Allowing a predetermined time for the cement to set in place.
- Conducting any needed remedial cement jobs (*e.g.*, top jobs – see Section 4.4.2).

#### *Mud Displacement*

Complete mud displacement during cementing operations is critical, since residual mud can form mud channels which can lead to inter-zonal communication, casing corrosion from exposure to formation fluids, and casing collapse from high pressure steam buildup in remnant mud pockets (Bour and Rickard, 2000). More specifically, the removal of the partially-dehydrated-gelled (PDG) mud adjacent to the mud filter cake can be inconsistent during conventional displacement operations. When a well is drilled, thin layers of mud cake and PDG mud tend to form on the walls of the wellbore due to static and dynamic

filtration (Figure 4.17). Removal of the PDG mud is a function of the shear stress imparted by a fluid flowing past it.

The higher the viscosity of a fluid at a given flow rate, the higher the shear stress imparted on the PDG mud, and the more efficient PDG mud removal becomes. The base slurry of foam cement (see the *Foamed Cement* section below) typically has relatively high rheological properties (viscosity increases proportionally to the amount of gas phase of the foamed slurry), making foamed cement slurries ideal for removing PDG mud and achieving excellent mud displacement during a cement job.

#### *Free Water*

When cement is pumped into place, it is critical that no free water be trapped between the cement and the casing, especially in sections where one casing is being cemented inside another. Water thermally expands when the well is heated up (for example, when the well first goes on production). If a pocket of trapped water is located next to the formation, the fracture gradient is typically low enough to allow that pressure to bleed off into a fracture (Finger and Blankenship, 2010). However, if a trapped water pocket occurs between cemented strings of casing, it can cause the interior casing to collapse and rupture, potentially allowing fluids to leak into the formation and necessitating a well work-over. There are certain additives that can be used in cement to reduce free water formation (see *Additives* section below).

#### *Pumping Methods*

Unlike oil and gas wells, geothermal wells must have a complete cement sheath from the bottom of the casing to the surface. This gives the casing mechanical support during thermal cycling and protects the outside of the casing from corrosion by reservoir fluids (Finger and Blankenship, 2010). Therefore, the cement must be solid all the way around the circumference of the pipe for the entire length of the pipe and careful planning of the cement job is important. A good example of step-by-step procedures for the preparation and implementation of a geothermal cementing operation can be found in Section 6 (Cementing Job) of E. K. Bett's paper *Geothermal Well Cementing, Materials and Placement Techniques* (Bett, 2010).

The three general methods of pumping cement down-hole that were introduced in Section 4.3 are here considered in greater detail. In all cases, during mixing and pumping operations samples of the cement slurry are collected, weighed, and stored, so that the slurry setup time can be monitored.

- Through-the-casing
  - This most commonly-used procedure involves introducing the slurry via a cementing head connected to the top of the casing, pumping a pre-calculated volume and then displacing the slurry from the casing into the annulus.
    - A water pre-flush of a specific volume is typically pumped into the well, immediately followed by a movable bottom plug (made of rubber, the bottom plug has a diaphragm that later ruptures to allow the cement to pass through). A low-specific gravity lead cement (or scavenge cement) is then pumped (Hole, 2008c), which aids in the removal of any remaining wall cake.

- The heavier lead or main cement slurry is then pumped. The main slurry is pumped at a sufficient flow rate to ensure that turbulent flow occurs within the annulus.
- Displacement is then done by placing another moveable rubber plug (solid, without a diaphragm) on top of the cement mixture after it is pumped down-hole, then using water or drilling fluid behind the plug to displace it downward, pushing the cement out into the annulus (Figures 4.9 and 4.10).
- The plug is displaced through the casing or cement pipe all the way to the float collar. During this time the casing is also reciprocated (rotated slightly back and forth) until the cement sets up enough to grab the casing and stick it in place (Hole, 2008c).
- Advantages of the through-the-casing method include:
  - Relative simplicity of the method and equipment used.
- Disadvantages of the through-the-casing method include:
  - Usually the volume of the casing string through which the cement is initially pumped exceeds the annulus volume to be cemented, and therefore a finite (calculated) cement slurry volume will be mixed and pumped. This in effect requires the displacement plug to be released, and displacement commenced, prior to any cement slurry actually reaching the annulus (Hole, 2008c).
- The “inner string” or “stinger” technique
  - A small diameter cementing string (sometimes drill pipe) is run inside the casing to be cemented in place and “stabbed” into a receptacle in a “float collar,” that is usually placed at the top of the first or second joint of casing as it is run in the hole. There is also a “float shoe” placed at the bottom of the casing string, which acts as a check valve to prevent the heavy cement from flowing back up the inside of the casing from the annulus. The cement slurry is then pumped through the cementing string, through the float collar and shoe, and up into the annulus. Once the pre-calculated volume of cement has been pumped, a rubber displacement plug is inserted into the cementing string, and displaced downwards with water, to remove all cement from the cementing string.
  - Advantages of the stinger method include:
    - The small volume of the cementing string allows the cement slurry to be mixed and pumped until good returns of cement are observed at the surface (Figure 4.10).
    - It reduces the amount of cement that needs to be drilled out of the wellbore, as well as the amount of cement-displacement time.
  - Disadvantages of the stinger method include:
    - It requires that the cementing ‘inner’ string must be picked up and run into the hole as soon as the casing is set in the rotary table. This does not create problems when cementing shallow strings of casing; however, the time required to pick up and run the cementing string on deeper production casings creates a higher risk of the hole packing off against the casing in weaker or unconsolidated sections of the wellbore (Bett, 2010).



- Reverse circulation
  - The cement is pumped directly into the annulus between the casing to be cemented and the newly drilled section of the hole (Figure 4.11). The fluid down-hole is displaced back through the casing shoe and up through the casing to the surface.
  - Advantages of reverse-circulation cementing include:
    - Lower pumping pressures, since gravitational force is working in favor of moving the slurry flow down the annulus.
    - Lower fluid pressure, which is specifically known as “equivalent circulating density” (ECD). This is the effective density that is a function of casing-fluid density combined with casing pressure drop. Because the heavier cement slurry is not circulated back to the surface, the ECD can be significantly reduced in reverse cementing compared to conventional cementing (Figure 4.12) (Bett, 2010).
    - Reduced waiting-on-cement (thickening) time, since minimal retarders are needed in the slurry. Additionally, a wiper plug is not needed, since nothing is pumped through the casing interior.
    - Improved compressive strength of the cement that is set in the upper section of the hole. Since this cement does not encounter high bottom-hole temperatures (and thus does not need retarder), a faster-setting cement can be pumped and this develops compressive strength more rapidly in the upper, cooler section of the wellbore.
  - Disadvantages of reverse circulation include:
    - it is more complicated to ensure that a successful cementing job has taken place; especially that the casing shoe has been cemented if there is loss of cement into the formation (see below)
    - The equipment that allows reverse circulation must be special ordered.
  - Three main types of reverse-circulation float equipment are commonly used (Figure 4.13): a float-and-stinger assembly; a pump-out-valve assembly; and a guide shoe. With either the pump-out-valve or the guide shoe, once cement placement is complete, surface pressure must be held on the casing while the cement sets (Hernandez and Nguyen, 2010).
  - Methods to confirm a good reverse-circulation cement job include (Hernandez and Nguyen, 2010; Rickard *et al.*, 2011c):
    - Circulating cement back to surface through a drill pipe stabbed-in to the float collar, to demonstrate that cement has filled the annulus (Figure 4.14). A disadvantage of this method is the increased friction from circulating up through the drill pipe, which increases the pressure in the annulus.
    - The no-float method, which uses a radioactive (RA) tracer in the lead cement, and a gamma-ray logging tool (Figure 4.15). The logging tool picks up the tracer in the leading edge of the cement as it is pumped down the annulus, and gives a stronger signal when the cement reaches the logging tool inside of the casing. This method ensures the cement

has filled the annulus without the need to displace cement to surface through the drill pipe.

- Reverse circulation has only recently been employed more regularly in geothermal well cementing. A mathematical model of a production-casing cement job at Puna that was developed by PGV showed that the formation fracture pressure in a proposed well plan would be exceeded by conventionally-circulated foam cement, because the frictional pressure of the cement moving up the annulus added to the hydrostatic pressure (Spielman *et al.*, 2006). Reverse circulation was used instead, as it kept the pressure just under the fracture pressure (the frictional pressure of the fluid moving down the annulus subtracts from the hydrostatic pressure). PGV notes that while the reverse foam cement jobs are complex (with 7 distinct steps and 14 valves to open and close between steps), they have been successfully conducted after thorough and detailed planning.

#### *Slurry Components and Characteristics*

The quality and integrity of the cement job on each casing string is critical in geothermal well construction and of particular concern in Hawaii. Tension and collapse failures of geothermal well casings can be caused by improperly cemented casing. Thermal expansion of voids or pockets of water in the cement sheath can also cause casing failures due to high temperature and thermal cycling. Acidic conditions outside the casing due to concentrations of CO<sub>2</sub> and H<sub>2</sub>S in the reservoir fluids can lead to corrosion failure if the cement sheath does not properly protect the casing. Down-hole parameters such as fracture gradient, temperature, and pressure play a role in the selection of the type of materials required for a successful cementing job.

The principal ingredient of most geothermal casing cement is a variety of Portland cement (other cement types are discussed below), which is “hydraulic” cement that sets and develops compressive strength through a hydration process (adding water) rather than a dehydration process, allowing it to be used in wet and dry environments. Dry Portland cement is typically composed of powdered lime (calcium oxide), silica (silicon dioxide), alumina (aluminum oxide), iron oxide, and gypsum (hydrated calcium sulfate). The hydration of this mixture (a set of chemical reactions with water) basically turns it into a set of interlocking mineral crystals that is equivalent to rock. Additives are mixed in to achieve the necessary resistant properties required by the wellbore conditions and chemistry and the entire mixture that is pumped down-hole, with water added, is called the cement slurry, and the exact slurry composition is determined by various parameters which include the following.

- Density
  - The natural fractures (permeability) and under-pressured conditions of geothermal reservoirs (due to the density difference between the hotter, less dense reservoir fluid and the colder, more dense column of wellbore fluid) require a cement slurry with high density, commonly at Specific Gravity (SG) between 1.7 and 1.9 (Hole, 2008c). This higher-density slurry commonly leads to incidents of lost circulation during cementing operations. Such losses are most-commonly mitigated by setting cement plugs during drilling, but additional approaches are used, including low-density cement additives, fracture sealing pre-flushes, foamed cement, and staged cement jobs, although these methods generally increase costs and down time.

- Setting time and strength development
  - Temperature and pressure are the two major influences on the down-hole performance of cement slurries. They affect how long the slurry will pump and how it develops the strength necessary to support the pipe (with temperature being having the more marked influence). The down-hole temperature controls the pace of the cement hydration that results in cement setting and strength development (Kutasov and Eppelbaum, 2012).
  - Assessment of the temperature development during hydration is also necessary to determine how fast the cement will reach an acceptable compressive strength before the casing can be released. Due to the high temperatures common in geothermal wells, cement hydration retarders are often used, and these can influence the expected temperature increase during the cement setting. According to HAR 13-183, all cement used in cementing the various types of casing required must contain a high-temperature-resistant admix, unless waived by the BLNR chairperson due to the particular circumstances existing in the well or the area (DLNR, 1981).
- Longevity (CO<sub>2</sub> resistance)
  - The high-temperature environments of geothermal reservoir systems require blending of additional materials to ensure longevity of the casing cement. Conventional cements used in oil and gas are too heavy for many geothermal wells and are more susceptible to attack by acids and CO<sub>2</sub>, resulting in increased porosity and decreased strength. Current industry standards require that Portland cements of API Class A or Class G be used in geothermal cementing operations (Hole, 2008c).
  - API specifications once recommend blending up to 40% by weight of cement (BWOC) of silica flour for the cementing of casing in geothermal wells. However, work conducted in the 1980s showed that this amount of silica added was too high, resulting in cement jobs with high porosity levels. This work indicated that silica flour amounts in the range of 15% to 20% BWOC were more efficient at providing both thermal stability and CO<sub>2</sub> resistance (Hole, 2008c).
  - See also CaP cement, which is discussed below.

Industry experience has led to the increased use of cements developed and tested for the conditions typically encountered geothermal wells. Table 4.4 compares the properties for three types of geothermal cements in currently use.

#### *CaP and SSAS Cements*

Brookhaven National Laboratory (BNL) led a joint laboratory-industry research program in the early 1980s and developed two economical cement types: calcium-aluminate-phosphate (CaP) cement and sodium-silicate-activated-slag (SSAS) cement (Finger and Blankenship, 2010). CaP cements were designed as CO<sub>2</sub> resistant for use in mildly acidic (pH ~ 5.0), CO<sub>2</sub>-rich environments. SSAS cements were designed to resist hot, strong acid containing a low level of CO<sub>2</sub>. Currently SSAS is only tested for conditions up to about 400°F.

Foamed CaP cement was successfully used recently on a geothermal well in Southern California to achieve long-term zonal isolation (Berard *et al.*, 2010), as described in greater detail in section 9.7. The

well was drilled in a highly corrosive (CO<sub>2</sub>) geothermal reservoir, and in such environments a traditional Portland cement matrix has been known to deteriorate due to carbonation reactions that also can cause serious damage to well tubulars over time and destroy zonal isolation integrity (Figure 4.16).

#### *Foamed Cement*

Foamed cement is well-suited for geothermal wells that are exposed to cycles of loading due to temperature fluctuations over the life of the well (Bour and Rickard, 2000). The light-weight nature of foamed cements eliminates the need for multi-stage cement jobs and lowers the likelihood of exceeding the formation fracture gradient and causing lost circulation. The ductile nature of foamed cement also makes it more resistant to stresses incurred by the pressure and temperature cycles that the cement sheath is exposed to, allowing it to yield better when internal casing pressures rise and expand the casing. Foamed cement also has properties that are well-suited for mud displacement, as was mentioned above (see section on *Mud Displacement*).

Cost benefits of foamed cement include the elimination of two-stage cement tools and a reduction in costs associated with setting LCZ plug materials during drilling (Bour and Rickard, 2000). In 2005, during the completion of PGV well KS-6, foam cement was successfully used for the intermediate casing, and foam cement was reverse circulated for the production casing (Spielman *et al.*, 2006). Two foam-cement jobs were more recently performed on PGV well KS-14 during the placement of the 16-inch casing (to 2,201 feet) and the 11-3/4-inch casing (to 4,878 feet). Both jobs were considered highly successful and successfully brought cement to surface (Rickard *et al.*, 2011c). The foamed cement allowed for a lower cement density and required just one base cementing design. This lowered both the ECD during cement placement and the final hydrostatic pressures at the end of the job, which resulted in lower cement losses and minimal (16-inch casing) to no (11-inch casing) cement fallback, thus increasing the cost savings on the well.

While the use of foamed cement has demonstrated some clear benefits in geothermal applications, some challenges still exist. Primarily, the conventional cement-bond logging methods lack the ability to effectively distinguish between foamed cement and drilling fluid, as their acoustic impedance is essentially equal to each other (conventional cement's acoustic impedance is significantly higher than that of drilling fluid) (Bour and Rickard, 2000). Additionally, the need for a nitrogen (N<sub>2</sub>) pumping unit to foam the cement increases the complexity of the foamed-cement operations. The N<sub>2</sub> and cementing units must be coordinated during pumping operations to ensure that the correct density of the prescribed mix of gas and cement is achieved (Bour and Rickard, 2000).

#### *Latex Cement*

Latex cement was originally designed to prevent corrosion from the naturally occurring acid and gases in reservoir fluids, including CO<sub>2</sub>. Treating cement with Latex yields slurries with excellent wetting properties, low base-slurry viscosities, and increased resiliency, which results in an overall increase in bonding strength (and therefore a tighter annular seal and superior zonal isolation). A special mix of latex-based Portland cement was successfully used in a geothermal well in Southern California. It was designed to improve acid resistance, fluid-loss control, and solids suspension under high-temperature conditions. Latex cements can also be foamed to yield a lower cement density, increased ductility, and a higher compressive strength (Hernandez and Nguyen, 2010).

### *Additives*

In order for cements to withstand changes in chemical, temperature and mechanical conditions over time (as well as the conditions encountered during emplacement, such as weak formations and lost circulation), certain additives are mixed with the cement prior to pumping it down-hole. There are several types of additives available for use, and these should be utilized based on the down-hole conditions expected and the specific temperatures, pressures and chemistries encountered during drilling:

- Accelerators (*e.g.*,  $\text{CaCl}_2$ ) are commonly used in the cementing of shallow, low-temperature wells where an increase in the hydration and setting time of the cement is needed, or to counteract the decreased setting times that can be caused by dispersants or fluid-loss agents (Michaux *et al.*, 1989).
- Retarders (*e.g.*, wood pulp) inhibit the setting of cement. When high bottom-hole circulating temperatures are expected, or when a well is particularly deep, a retarder may be added to prevent set-up prior to completion of pumping of the slurry. Careful estimation and testing of the maximum and minimum circulating temperatures is required for effective use of retarders (Hole, 2008c).
- Fluid-loss control agents (*e.g.*, bentonite) control water loss from the cement into the formation. When cement is placed adjacent to a permeable section of the reservoir in which the fluids are under pressure, water from the cement slurry tends to escape into the formation. This dehydration can result in annular bridging with high-water-loss slurries. The addition of fluid-loss-control agents binds the water fraction within the slurry, reducing this tendency (Hole, 2008c).
- Dispersants (*e.g.*, polymers) reduce the viscosity of the cement and assist in mud removal. Dispersants can also allow the water content of the cement to be lowered without affecting the ability to pump it (Michaux *et al.*, 1989).
- Lost-circulation agents (*e.g.*, mica) reduce the loss of cement into weak or permeable formations. It is critically important that organic LCM (often used to cure LCZs during drilling) is not used for cementing casings. If organic LCM is used to cure losses during cementing, the organic material will be carbonized during heat-up, leaving high porosity within the loss zones and providing a flow path for corrosive fluids (Hole, 2008c).
- Weighting agents (*e.g.*, barite) increase cement density. In wellbores with unstable sections of formation or high gas content, a higher density fluid is needed to safely drill out the well. These higher density muds require higher-density cements for displacement.
- Friction reducers are used to reduce cement-slurry shear stress and thus reduce necessary pumping pressures (Michaux *et al.*, 1989).
- Free-water additives ensure that no free water evolves during the setting of the cement.

## 4.4 Other Special Considerations

### 4.4.1 Lost Circulation Zones (LCZs)

The most expensive problem routinely encountered in geothermal drilling is lost circulation (that is, losses of drilling fluids to the formation). Costs to control lost circulation represent about 10% of total well costs in mature geothermal fields and often more than 20% of the costs in exploratory wells and developing fields (Finger and Blankenship, 2010).

Taking account of LCZs is critical to the success of cementing operations. In non-production intervals, it is preferable to cure LCZs with cement plugs during drilling, in order to reduce later cement losses during the process of installing casing. Otherwise, the LCZs must be accounted for and dealt with when the casing is installed and additional procedures must be used to ensure a successful cementing job. This can be both costly and time-consuming.

When casing cement losses occur in spite of having emplaced cement plugs during drilling, it may be necessary to utilize one or more of the following methods:

- Use low density cement additives;
- Pre-flush the wellbore with a sodium-silicate-based sealant;
- Use foamed cement;
- Conduct “top jobs”;
- Conduct staged cement jobs;
- Use tie-back casing strings.

As mentioned previously in this guide, the shallow formations in the KERZ and the fractured nature of the volcanic reservoirs at depth have been shown to create numerous incidents of lost circulation, during both drilling and cementing operations. Appropriate cementing procedures for the surface, intermediate, and production casings need to be carefully evaluated. A detailed, integrated analysis of the mud log and the lost circulation record is essential for this purpose.

Any remedial process that is used absolutely must prevent water being trapped between casing strings, because such water will later cause the inner string to collapse when it is heated up (Finger and Blankenship, 2010).

### 4.4.2 Top Jobs and Backfills

Because geothermal casings must be cemented completely back to surface, there is often a problem getting a competent cement job where the formations have shown either low strength or lost circulation. Methods using light-weight or foamed cement have proven successful in many geothermal wells when the casing and cementing program is carefully developed to suit the resource, but cement losses can still occur.

If the cement has fallen back but is still very near the surface, it can be repaired by a top job, in which cement is pumped into the annulus from the surface through small-diameter tubing (“tremie pipe”). This

method is commonly only effective to place cement in the casing annulus down to the first centralizer, as the tremie pipe frequently cannot pass the centralizer. It is common practice specifically not to place centralizers on the top two joints of casing as a means of ensuring a deeper top job can be conducted if necessary (Finger and Blankenship, 2010).

If there is a BOP on the well, a flush-and-backfill process can be used when cement returns to the surface are lost. Immediately following the primary cement job, the BOP can be closed around the casing, and the annular space between the casings can be flushed with water to remove any cement before it sets (a standard volume estimate of 1.5 times the casing-to-casing annular volume is used) (Hole, 2008c). When the initial flush is complete, water is continuously pumped down the annulus to maintain a hydraulic connection with the top of the permeable zone in which the cement was being lost.

Once a backfill slurry is mixed (commonly the same mix as the primary cement job, less any retarders that may have been used), it is pumped into the annulus. This entire volume must be pumped to ensure that any fluid remaining in the annulus is displaced, and that cement has filled the annulus, typically indicated by a pressure increase (Hole, 2008c). If this is completed successfully, the final procedure is to wait for a period of about 30 minutes for the cement to settle, top off the annulus and apply a slight “squeeze” to ensure that the cement has been forced slightly into the formation and has good bond with the casing.

If the annulus has not pressured up, it may require hesitation squeezing, or a second stage of flush and backfill in extreme cases. As discussed above, it is critical that no water be trapped between the cement and casing. When conducting a top job, if the tremie pipe does not reach the top of the cement, there is too much risk of trapping water (and collapsing the casing), and this method should not be used.

#### 4.4.3 Sacrificial Liners

Sacrificial liners (or hang-down liners) are protective, solid-steel liners installed in injection wells, and they are effectively the tubing through which fluid is injected. The liner is smaller in diameter than the production casing, and it is installed upon completion of the well. The uppermost part of the sacrificial liner is hung from a spool below the master valve, and it is hung in suspension (un-cemented) to a depth near the top of the slotted liner below. The annulus between the production casing and the sacrificial liner can then be charged with an inert fluid (such as nitrogen) for added protection against corrosion of the cemented production casing.

#### 4.4.4 Strength at High Temperatures

Commonly used casing materials lose strength at elevated temperatures, with the loss being more pronounced for higher the grades of steel. For example, the yield strength of K-55 casing decreases from 388 MPa at 25°C, to 359 MPa at 371°C, but quenched-and-tempered L-80 yield strength decreases from 632 MPa to 484 MPa over the same range of temperature increase (Finger and Blankenship, 2010).

Casing selection during the planning process should include consideration for the high temperatures known to exist in Hawaii. Additionally, cements planned for use during the drilling operations should be evaluated by the cementing operator’s lab for potential changes in additives in order to accommodate the conditions encountered down-hole.

#### 4.4.5 Casing Availability

It is not uncommon for casing procurement to have a very lengthy lead time (up to several months), especially for specialty grades or uncommon sizes. This needs to be factored in with the transportation issues unique to Hawaii during the planning process, allowing for ample procurement time. Alternatives can be implemented; however, this is frequently at a substantial increase in both cost and time.

#### 4.4.6 Fluid Chemistry

##### *Casing Corrosion Resistance*

Materials used in high-temperature geothermal wells can be subjected to corrosion due to the corrosion aggressiveness of the geothermal fluid that contains dissolved gases such as H<sub>2</sub>S, CO<sub>2</sub>, and (in very uncommon cases) hydrochloric acid (HCl) (Karlsdottir *et al.*, 2012).

Almost all geothermal reservoirs are known to produce H<sub>2</sub>S, and CO<sub>2</sub> is the most commonly found non-condensable gas (Finger and Blankenship, 2010). While these gases contribute to the corrosion problem, H<sub>2</sub>S in particular limits the materials that can be used for drilling equipment and for casing to the lower-strength steels, because higher-strength steels will fail by sulfide stress cracking. This limits the available materials for casing to those that meet the National Association of Corrosion Engineers International (NACE) MR0175 standards for resistance to sulfide stress cracking (Lichti *et al.*, 2005). ANSI/NACE MR0175/ISO 15156 provides the requirements and recommendations for the selection and qualification of carbon and low-alloy steels, corrosion-resistant alloys, and other alloys for service in equipment used in H<sub>2</sub>S-containing environments, whose failure could pose a risk to the health and safety of the public and personnel or to the equipment itself. In addition, a number of geothermal reservoirs are challenged by problems caused by the chemistry of the geothermal fluid in the reservoir. Brine quality varies greatly between resources, ranging from near-potable to highly corrosive with high dissolved-solids content. Many techniques – cement-lined casing, exotic alloys, and corrosion-resistant cement – have been applied to the casing-corrosion problem, which is known to be especially severe around the Salton Sea in California, where shallow and hot CO<sub>2</sub>-bearing zones accelerate corrosion rates.

##### *Scaling*

Brine chemistry also affects scaling, which is the buildup of mineral deposits in the production interval, inside the casing and even in surface facilities. Scaling is an ongoing issue for many (not all) geothermal operations worldwide and can lead to somewhat costly, frequent work-overs and other treatments (Finger and Blankenship, 2010).

Scale buildup inside the casing can severely reduce flow in relatively short periods of time if not addressed. In some cases, scale can be removed mechanically with high-pressure jets, and chemically with acid pumped down the wellbore. The industry preference is to inhibit scale formation rather than allow it to build up and have to remove it, and there are many chemical techniques currently in use. Wellhead pressure can also determine at what depth the reservoir fluid will flash during production and can be used to control build up (operating at a higher wellhead pressure can sometimes slow the growth of scale).



## 5. BLOWOUT PREVENTION

### SUMMARY

- 5.1 Introduction: Circumstances that increase the potential for developing conditions under which blowouts may occur.
- 5.2 Blowout Classification: Types of blowouts, definitions and descriptions
  - 5.2.1 Surface Blowouts: Casing-contained and externally-vented.
  - 5.2.2 Underground Blowouts: Internal wellbore flow and outflow at the casing shoe.
- 5.3 BOP Equipment: Wellhead BOP equipment (BOPE) and why it is needed.
  - 5.3.1 Definitions, Functions and Planning Design: BOPE components, functions, minimum requirements, and parameters.
  - 5.3.2 BOP Classification: BOPE classifications.
  - 5.3.3 BOP Installation in Hawaii: Recommendations for BOPE applications.
  - 5.3.4 Equipment Testing and Inspection: Regulations and requirements for BOP testing and inspection.
  - 5.3.5 Special Considerations for Hawaii: Parameters and conditions specific to Hawaii BOPE.
- 5.4 Blowout Incident Procedures: Common causes of a well kick.
  - 5.4.1 Kick Identification: Indications of potential kick in the wellbore.
  - 5.4.2 Kick Control: Well control procedures for various drilling conditions.
  - 5.4.3 Post-Completion Blowout Prevention: Potential risks of blowout after drilling is completed.
  - 5.4.4 Blowout Prevention in Slim Holes: Considerations for smaller-diameter wellbores.
- 5.5 Drilling Fluids and Geothermal Well Control: The use of fluids as a means of well control during drilling operations.
- 5.6 Drilling Monitoring: Importance of monitoring during drilling to reduce risks of a blowout.
  - 5.6.1 Monitoring Rationale in Hawaii: Considerations for issues specific to Hawaii.

- 5.6.2 Categories of Monitoring Data: The key parameters used to identify potential blowout conditions.
- 5.6.3 Monitoring for Blowout Prevention: Key drilling parameters to monitor for indications of potential blowout conditions.
- 5.7 Supervision and Training: Importance of properly trained supervisors and drilling teams in geothermal drilling practices.

Prevention of an uncontrolled well flow (commonly known as a "blowout") during drilling and at any other time is of vital importance for geothermal operators, drilling crews, state and county regulators, and the general public. Geothermal well blowouts are not as dangerous as blowouts in the oil and gas industry, in large part because they are not associated with any danger of fire. However, blowout incidents can cause injury, have a negative impact on surface and subsurface environments, damage rig and down-hole equipment, cause resource waste and develop unfavorable public perceptions of geothermal activity. Blowouts in the geothermal industry world-wide are not common, but those that have occurred have been very costly and time-consuming to remediate.

During drilling, well control is the practice of maintaining adequate pressure on down-hole formations to prevent or direct the flow of formation fluids into the wellbore. It also encompasses the operational procedures to safely stop a well from flowing should an influx of formation fluid occur.

If drilling advances into a fractured or permeable zone where the pore pressure in the formation is higher than the static head of the drilling fluid in the wellbore, the formation fluid will flow into the wellbore (called a "kick"). For safety reasons, every kick should be treated as a gas kick until it is confirmed otherwise, as it may contain unknown levels of H<sub>2</sub>S gas. This process can occur almost instantaneously. The potential for a steam kick is always there and requires special drilling crew training and attention. If control of the kick is lost, the resulting disaster is a blowout.

A competent drilling plan should contain a detailed blowout-prevention strategy. The implementation of risk reduction should be evident in the casing, cementing and drilling fluid provisions, in the drilling-monitoring procedures, in proper training and experience of personnel, in the blowout prevention (BOP) stack that is attached to the wellhead, and in the BOP supplemental equipment. Blowout prevention is every operator's ultimate responsibility, achieved first in the thought and actions of all drill site personnel through training, by practicing sound procedures, and by using appropriate and reliable equipment (Patterson *et al.*, 1994a). The essential components of a successful and competent blowout prevention strategy include:

- Risk analysis and well planning.
- Selection of sound blowout prevention equipment.
- Rigorous drilling monitoring procedures.
- Expertise in kick control and blowout prevention equipment utilization.
- Excellence in supervision and training of drilling personnel.

The objective of this Chapter is to promote safe operating procedures and working practices and encourage good resource management by discussing and describing blowout prevention as it can best be practiced in Hawaii.

## 5.1 Introduction

Two situations that can cause a loss of control are: (a) ascent of hot fluids from depth to the surface, with boiling and a loss in hydrostatic pressure; (b) a loss of drilling fluid circulation, which causes the fluid level and associated pressure in the wellbore to suddenly drop and triggers boiling in the well.

A geothermal well is commonly filled with a column of water often heated to the boiling point, where even the slightest reduction in pressure on that column can cause some or all of the water column to boil and flash to steam (Hole, 2008b). While there are a number of “over-pressured” geothermal fields in which the shallow pore pressure is greater than a hydrostatic column, most geothermal fields are “under-pressured” and the formation pore pressure is less than the drilling fluid pressure in a full wellbore. During drilling, a well in an over-pressured field may flow unless the pressure in the fluid-filled wellbore exceeds the formation pressure, and a well in an under-pressured field may flow when there is a drop in the wellbore pressure.

### *KERZ drilling*

KERZ geothermal drilling experiences have encountered two significant hazards (see Section 1.2) that must be addressed in a blowout-prevention strategy for each proposed well:

- Significant fault and fracture planes can act as sealed conduits for over-pressured geothermal fluids. Therefore, proper casing depth design and blowout prevention planning, equipment and procedures must be taken as a critical requirement, ready for immediate and proficient use.
- The recognition of weak or broken formations through routine formation leak-off testing (LOT) should be conducted at the level of every cemented casing shoe as a precursor to obtaining a reliable casing anchor, which is fundamental to safe blowout prevention when the well has to be completely shut off during drilling.

## 5.2 Blowout Classification

Any loss of control of the natural pressures and fluids or steam encountered in the drilling of a well constitutes a blowout. A discharge of these fluids at the surface is usually taken as the initial identifier of a blowout. However, surface discharge, if it occurs, is only the symptom or consequence of the fundamental upset condition.

Different upset conditions, in turn, yield several different types of geothermal well blowouts, varying in severity and control techniques. The impacts on surface and subsurface environments, resource waste, and public perceptions of these incidents demand that operators and regulators minimize the risks of blowouts.

The types of blowouts that may be experienced in Hawaii are as follows.

### 5.2.1 Surface Blowouts

#### *Casing-Contained*

An uncontrolled flow of steam or fluids from the well casing at the surface will result in the escape of fluids and emissions to the atmosphere. This may result in unabated gas emissions and disruptive noise to the surrounding community and the surface environment surrounding the well. This type of blowout may cause minor to major damage to the wellhead, BOP equipment or drilling rig. Responses to a blowout will vary and depend on the specific situation. Efforts will focus on control of fluid discharge, wellhead repairs and access to the area for specific procedures. The availability of drilling fluid supplies (including water), and the condition of the drilling string and casing will be key elements in an effective operation to regain well control.

### *Externally Vented*

Externally vented blowouts represent discharge to the surface from outside the well casing and can have varying severities:

- In a moderate case, low-to-moderate fluid venting occurs outside the casing or in the cellar; the drilling rig, wellhead, and BOP are generally undamaged and remain operable. The blowout noise and emissions may not affect the surrounding community. Responses may include grouting of the leaking zone to terminate surface flow.
- In a worse case, the venting of large volumes of fluids at high velocity leads to severe rig damage, collapse and/or cratering around or near the wellhead. Human life might be endangered due to the rapid turn of events. Response will probably require drilling a relief well if the hole does not bridge or collapse on its own, terminating the flow.

### 5.2.2 Underground Blowouts

An underground blowout is an uncontrolled flow of formation fluids from one down-hole zone to another one and is most commonly characterized by a general lack of pressure response from the annulus while fluids are pumped down the drill string (this is different from a pressure drop due to a loss of circulation) (Grace, 2003). Though an underground blowout typically lacks any surface manifestation, the event could escalate into a surface blowout if the condition is not recognized and resolved. There are two types of flow in an underground blowout:

#### *Internal-Wellbore Flow*

Fluid from a high-pressure zone flows upwards in the open (un-cased) section of the hole to a shallower permeable zone with a lower formation pressure (*e.g.*, a lower-temperature reservoir or groundwater zone). Such events may range from minor fluid losses to serious degradation or destruction of the open hole. The response is generally to subdue the flow with water, weighted muds, or cement plugs as required. Additional casing or liner will likely be required, or the well may be plugged with cement for re-drill, suspension, or abandonment.

#### *Outflow at the Casing Shoe*

Fluid from a high-pressure zone flows upwards in the open hole, increasing the fluid pressure at the shoe of the last cemented casing until it is greater than the formation pressure at that depth; it then hydraulically fractures the formation and escapes outwards from the wellbore. As a variation, the fluid may fracture the cement at the casing shoe and travel up the annulus behind (outside of) the casing, to some point higher up where it enters the formation. The response is similar to an inner-wellbore blowout (attempting to subdue the flow with water, weighted muds, or cement plugs, as required).

Underground blowouts are probably the most expensive problem in the drilling arena, eclipsing the costs of even surface blowouts. It may prove necessary to drill a relief well (a second well designed to intersect the bottom of the original well) in order to kill the original well and remedy the underground blowout.

### 5.3 BOP Equipment

The blowout-prevention stack on the wellhead, when all other well-control procedures have failed, must function reliably to obtain a complete closure or effective control of unexpected fluid flows from the

wellbore, and Hawaii's geothermal drilling industry has gained sufficient experience and information through the past 30 years to provide reasonable guidance to the identification of reliable and safe blowout-prevention equipment.

Blowout-prevention stacks and related equipment are not simple systems; they rely on integrated mechanical, hydraulic and electrical processes to operate. Both redundancy and sophistication exist; however, the risks of human error in critical situations have not been eliminated. Blowout-prevention systems require careful selection, maintenance and repetitive training of drilling personnel to attain the reliability and safety that are essential in the final defense against an actual blowout.

### 5.3.1 Definitions, Functions and Planning Design

#### *Definitions*

The term *blowout-prevention equipment (BOPE)* as it is used here means the entire array of equipment installed at the well to control kicks and prevent blowouts. It includes the BOP stack, its closing (actuating) system, kill and choke lines and manifolds, kelly cocks, safety valves and all auxiliary equipment and monitoring devices (see Appendix B for definitions of all terms).

The *BOP stack* is the combination of preventers, spools, valves, and other equipment attached to the wellhead during drilling operations.

A *diverter stack* is a BOP stack that includes an annular preventer or a rotating head with a vent line beneath. A valve is installed in the vent line so that the valve is open whenever the annular preventer is closed, thus avoiding a complete shut off (CSO) and diverting the flow of fluids away from the rig and personnel and into the sump.

A *full BOP stack* is an array of preventers, spools, valves, and other equipment attached to the wellhead such that a CSO is possible under all conditions.

#### *Functions*

The main function of the BOP equipment is to safely control the flow of fluids at the surface, either by diversion or by complete shut-off. The equipment must be adequate to handle a range of fluid types, pressures, and temperatures, and to accommodate different drilling situations such as active drilling and tripping, or while the drill string is out of the hole. The requirements of the BOP stack are:

- To close the top of the wellbore to prevent the release of fluids, or to safely divert the fluids away from the rig and personnel.
- To allow for the safe, controlled release of shut-in, pressured fluids through the choke lines and manifold.
- To allow for the pumping of drilling fluids into the wellbore through the kill lines.

The BOP stack is composed of multiple types of devices, all of which are designed to shut off the wellbore and prevent fluid flow out of it. The basic function of each component is the same, but they operate in slightly different ways.

- Rotating head: forms a seal around the drill pipe and rotates with the drill pipe. This is enabled by encasing the drill pipe seal and bearings in a sealed housing. This is normally a low-pressure device whose main purpose is to keep hot fluids from reaching personnel on the drill rig during normal drilling operations.
- Annular preventer: either an inflatable bladder or elastomer (“bag”) that is forced into the cavity by a hydraulic piston (Figure 5.1). The flexible element seals around drill pipe, casing, drill collars, or any irregularly shaped components of the drill string to stop fluid flow. It allows drill pipe to be stripped out of the hole while the bladder is inflated. The bladder can also seal with no pipe inside.
- Pipe rams: two sliding gates with semi-circular cutouts that come together from each side of the drill pipe. The hole in the center fits and seals around the outside diameter of the drill pipe. Variable-bore rams have gates that can seal around either the pipe body or the larger tool-joint diameter. The internal sealing elements of the BOP gates are faced with high-temperature rubber.
- Blind rams: two solid sliding gates (no hole in the center), used when the drill pipe is out of the hole.
- Shear rams: two sliding gates with sharp, hardened, overlapping edges designed to sever anything hanging in the wellbore. If these are used, then anything cut by them falls into the hole and becomes a fish; thus, they are typically considered a last resort. Most geothermal BOP stacks do not include shear rams when drilling, although they can be an important part of workovers that involve removing damaged casing from the wellbore.

Below the BOP stack is the drilling spool with two valved lines connected to the drilling spool so that fluids can be either released from (choke line) or pumped into (kill line) the wellbore as part of the well-control process.

#### *Planning Design and Component Specifications*

Selection of BOP stacks and equipment should be made jointly by an experienced geothermal drilling engineer and drilling supervisor. It is preferable to employ a supervisor who is experienced in Hawaii geothermal drilling experiences and conditions.

Some common industry recommendations for BOP components are as follows:

#### **Diverter stack:**

- A minimum pressure rating proportional to the formation pressures expected at the bottom of the surface casing.
- A minimum vent-line diameter of 12-inches.
- The vent line directed through a muffler.
- H<sub>2</sub>S-abatement capability connected to the vent line.

#### **Full BOP stack:**

- A minimum pressure rating of 3,000 psi for all components. A pressure rating of 5,000 psi is recommended when indicated by the risk analysis of the well. (For temperature impacts on pressure ratings, see Table 5.1) (Patterson *et al.*, 1994a).
- Lower spool outlets: 2-inch diameter for a kill line and 4-inch diameter for a choke line.
- The pressure ratings for the kill and choke lines must be the same as the stack.
- All preventers should have high-temperature-rated ram rubbers and packing units.

**Kill Line:**

- Two full-opening valves and one check valve at the spool.
- Fittings for an auxiliary pump connection.
- Must not to be used as a fill-up line.

**Choke Line and Choke Manifold:**

- Two full-opening gate valves next to the spool; one remotely operated.

**Actuating system:**

- The actuating system should have an accumulator that can perform all of the following after its power is shut off: close and open one ram preventer; close the annular preventer on the smallest drill pipe used, and; open a hydraulic valve on the choke line, if used (Figure 5.2).
- The actuating system is to be located at least 50 feet from the well, with two control stations - one at the driller's station on the rig (no more than 10 feet away) and one at the actuating system location (Figure 5.3).
- Valves may be hydraulically or manually operated, as appropriate for the intended service; however, valves should be operable from a remote hydraulic control or by mechanical extensions if they are located where they are not readily accessible during a well-control incident.

Other equipment to be provided:

- Upper and lower kelly cocks, and a stand-pipe valve.
- A full-opening safety valve to fit any pipe in the hole, which is to be kept on the rig floor.
- An internal preventer with fittings to adapt it to the safety valve, which is to be kept on the rig floor.
- Accurate pressure gauges on the stand pipe, choke manifold, and other suitable places that may see wellbore pressure.
- All flow lines and valves rated for high-temperature service.
- A blow-down line fitted with two valves installed below the BOPE. The blow-down line shall be directed in a manner so as to permit containment of produced fluids and to minimize any safety hazard to personnel.



### 5.3.2 BOP Classification

Depending on the stage of the well being drilled and its depth, different BOP stacks will have to be installed each time a new casing string is cemented. Each new BOP stack will have to have sufficient diameter to allow the free passage of the tools that will be used to drill the next section of the well. The standard classification is by Class, normally ranging from Class I to Class V. Geothermal industry standards mostly use Class I through III, and rarely, for some operations involving air drilling, Class IV. Class V BOPs are used for sub-sea installations.

A Class I BOP installation consists (as a minimum) of any device installed on the wellhead that can be closed completely when the pipe is out of the hole. This installation is normally used in combination with a diverter, attached to the conductor pipe. A Class II BOP installation will include an annular and a ram-type BOP; the ram could be single-ram (blind) or double-ram (blind and pipe ram). Depending on the nature of the formations being drilled, a Class II BOP is normally attached to the surface casing. A Class III BOP, normally attached to the intermediate casing (or last cemented casing reaching the surface), will consist of an annular BOP, a double-ram (blind and pipe rams), and spools with valved inlets to allow injection of killing fluids (water, mud, weighted mud) or circulating out fluids being produced from the well (steam, hot water) away from rig and personnel (Figure 5.4).

At each well stage or casing diameter, BOP stacks will be installed on top of a casing head or flange that is welded to the last cemented casing pipe. The casing head must have two flanged side inlets with valves (minimum 2-inches) and properly rated for the maximum BOP pressure rating that will be used during well drilling.

In all cases, the BOPs have to be connected all the time to a pressure-accumulator unit, capable of closing all the BOPs in the stack within 2 minutes. The accumulator must have an independent emergency backup system with enough volume of usable fluid to close the annular preventer. The system will have to include two control stations, one installed in the vicinity of the driller's station (no more than 10 feet away) and the second near the actuating system accumulator.

### 5.3.3 BOP Installation in Hawaii

Figure 5.5 shows the Class III BOP arrangement that is recommended before drilling into the reservoir zone in Hawaii. In this diagram, the top component (green) is the Rotating Head. This element allows rotation of the drill pipe and directs normally circulating drilling mud to a flow line. Below this, a spacer spool (gray) separates the Rotating Head from the BOP equipment. The temporary BOP equipment (red) is used only during drilling operations. The Master Valve (blue) is a permanent part of wellhead equipment for the lifetime of the well.

The BOP components in Figure 5.5 from top to bottom are:

- Annular preventer.
- Double-ram preventer.
- Flow tee (remote-actuated valve on the horizontal side outlet, leading to the muffler in case venting is necessary for safety).

- In some rare cases (Class IV BOP), another double-ram preventer – similar to the one installed above, except internal sealing elements are faced with steel; this is normally used in drilling situations with circulation of very hot fluids, such as air drilling.
- Another spacer spool with side ports (“kill line” or “choke line”).

#### *Surface Casing BOP*

A BOP stack (Class II) consisting of an annular preventer and single or double ram should be installed on the surface casing. In Hawaii, this casing is typically either 20 inches or 22 inches in diameter, and it is cemented to approximately 1,000 feet. Incompetent near-surface volcanic rock and the high risk of cementing failure will not provide an adequate BOP anchor for the surface casing. CSO is not required with this equipment; diversion of fluids is deliberate to avoid creating externally vented blowouts, and for personnel and rig safety.

#### *Intermediate Casing BOP*

A full BOP stack (Class III) should be installed on the intermediate casing. In Hawaii, this casing is typically either 13-3/8-inches or 16 inches in diameter, and it is cemented between 2,000 to 4,000 feet, depending on the reservoir depth. This deeper casing (and the cement sheath and host rock surrounding it) serves as a BOP anchor. The selection and arrangement of this stack allows for the use of a full range of drilling fluids (mud, water, aerated fluid, foam, air) and it should be a geothermal-industry-premium stack that is capable of confident, immediate CSO over the range of temperatures and pressures anticipated. If a sufficient BOP anchor is not obtained, this stack also has diverting capabilities by means of the flow "T" / vent line, or banjo-box / blooie line, included in the stack (see Section 5.3.5 for further details on the BOP anchor).

#### 5.3.4 Equipment Testing and Inspection

As stated in HAR 13-183, BOPE pressure tests may be observed by a DLNR representative on all exploratory wells prior to drilling out the shoe of the surface casing (DLNR, 1981). The decision to require and observe BOPE pressure tests on other types of wells shall be made on a well-by-well basis. The DLNR shall be contacted in advance of a scheduled pressure test to allow time for travel to the well site to witness the test.

In general, a visual inspection and an initial pressure test should be made on all BOP equipment when it is installed, before any casing plugs are drilled out. The BOP stack (preventers and spools, choke and kill lines, all valves and kelly cocks) should be hydraulically tested (Figure 5.6). In addition to the initial pressure and operational test at time of installation, periodic operating tests should be made.

Pressure tests should subject the BOP stack to a minimum of 125% of the maximum predicted surface pressure. If the casing is tested at the same time, then the test should not be more than 80% of minimum internal yield of the casing at the shoe. If a test plug is used, the full working pressure of the BOP stack can be tested and a casing test would be made separately. Testing of the actuating system should include tests to determine that:

- The accumulator is fully charged to its rated working pressure.
- The level of fluid is at the prescribed level for that particular unit.

- Every valve is in good operating condition.
- The unit itself is located properly with respect to the well.
- The capacity of the accumulator is adequate to perform all necessary functions including any kick-control functions such as operating hydraulic valves that are using the same unit for energy.
- The accumulator pumps function properly.
- The power supply to the accumulator pump motor will not be interrupted during normal operations.
- There is an adequate independent backup system that is ready to operate properly.
- The control manifold is at least 50 feet from the well and a remote panel is located at the driller's station.
- All control valves are operating easily and properly, have unobstructed access and easily identifiable controls.

The sequence of events to test the BOP stack and all other valves depends on the stack configuration, but it is important that all equipment be tested, including the annular preventer, pipe rams, CSO rams, upper and lower kelly cocks, safety valves, internal preventers, standpipe valve, kill line, choke manifold and choke control valve, pressure gauges, and any other items that are installed as part of the BOP equipment.

In addition to the testing of BOP equipment when it is first installed, there should be frequent BOP testing and drills. The closing system should be checked on each trip in or out of the hole and BOP drills should be held at least once a week for each crew. It is most important that every member of the crew be familiar with all aspects of the operation of the BOP equipment, along with all of the accessories and monitoring devices that aid in detection of a kick. The main purpose of drills is to train the crew to detect a kick and close the well in quickly. BOP drills should cover all situations while drilling, tripping, and with the drill string out of the hole.

#### 5.3.5 Special Considerations for Hawaii

##### *High Wellhead Temperatures*

In Hawaii, where wellhead temperatures in excess of 600°F may occur, Operators must consider the pressure de-rating of steel valves and BOP equipment due to such elevated temperatures when selecting wellhead equipment. API Specification 6A provides the recommended working temperatures for steel at high temperatures. Note that this table goes only to 650°F (see Table 5.1).

In addition to the steel valves used in the wellhead equipment, the temperatures found in Hawaii far exceed the temperature ratings of elastomers found in most BOP equipment. Operators often use all-steel rams in ram-type preventers for a more effective seal. The API recognizes temperature ratings of elastomers up to 250°F, but some manufacturers can now produce elastomers that are rated to about 400°F.

### *BOP Anchoring Criteria*

Having CSO capability with a BOP stack requires the existence of a BOP anchor that is sound according to three key criteria:

- A mechanically sound, continuous steel casing of reasonable length, which probably will be hundreds to thousands of feet, attached to the BOP stack.
- A continuous and solid cement sheath in the annulus between the new casing and the previously cemented casing or between casing and the rock wall of the wellbore.
- An impermeable rock interval around the wellbore and cement sheath. The entire section of rock need not be impermeable, but priority is given to placing and cementing the casing shoe in a thick interval of competent and impermeable rock.

### *Unpredictable Subsurface Conditions*

Geothermal drilling in Hawaii has inherent risks due to the unpredictability of the subsurface conditions. Recognizing the risks and being prepared for all possible conditions is the best form of blowout prevention. Subsurface conditions that may pose a risk of well blowout are as follows and considered further, for Hawaii, in Section 5.6.1:

- The almost certain inability to obtain a sound BOP anchor with surface casing in the weak and vertically permeable near-surface volcanic rocks. As discussed in Section 5.2.1, if a "kick" occurs, these shallow rocks will not allow a CSO at the wellhead without posing a significant risk of creating an externally-vented well casing blowout.
- The unexpected entry, while drilling, into a major fault and fracture conduit which is charged with over-pressured geothermal fluids. In the KERZ, sudden geothermal fluid flows have previously been encountered at depths shallower than expected, registering 500 to 700 psi shut in wellhead pressures. Termination and control of such events requires the certainty of a wellhead CSO with a full-capacity BOP stack.

The risk factors cited above reveal the importance of knowing when a BOP anchor and consequent CSO capacity are available to prevent a blowout. If they are not available, diversion of uncontrolled flows is judged to be the more prudent response.

### 5.4 Blowout Incident Procedures

In drilling terms, a 'kick' is often the first indication at the wellhead that there are problems with control of formation pressure. A kick is defined as the entry of formation fluids (water, steam, or gases) into the well, which occurs because the hydrostatic pressure exerted by the drilling fluids column has fallen below the pressure of the formation fluids. If prompt action is not taken to control the kick and to correct the pressure underbalance, a blowout may follow.

Some of the main causes of these pressure imbalances are:

- Insufficient drilling mud weight.
- Failure to properly fill the hole with fluids during trips out of the hole (*i.e.* when the drill pipe is removed).

- Swabbing when pulling pipe. If the drill string is pulled from the hole too rapidly, the pressure may be reduced, allowing formation fluids into the bore.
- Lost circulation.

#### 5.4.1 Kick Identification

The primary method of detecting a kick is to compare measurements of the drilling fluid inflow and outflow rates; if outflow is greater, there is a kick, if inflow is greater, there is loss of circulation. There are a number of warning signs that indicate that a kick is occurring or that it may soon occur. Some of these signs, which may not be present in all situations, are:

- An increase in the flow rate of returning drilling fluids, while pumping at a constant rate.
- An increase in mud-pit volume.
- A continuing flow of fluids from the well when the pumps are shut down.
- Hole fill-up on trips is less than the calculated amount.
- A pump pressure change and a pump stroke increase while drilling.
- An increase in drill-string weight.
- A drilling break (sudden increase in the rate of penetration).
- Gas-cut mud or reduced mud weight at the flow line.
- Lost circulation.
- A rapid increase in flow-line temperature.

Since the mud is circulated from the mud pits (open-top tanks on the rig) down the hole and back to the mud pits, the usual method of determining a kick or lost circulation is to monitor the level in the mud pits. Flow can also be measured by counting the strokes on the mud pumps and using a calculation to give the mud volume pumped; however, pump efficiency varies with wear and can be inaccurate.

Each of the kick warning signs mentioned above does not positively identify a kick. However, they do warn of a potential for a kick. Every driller should be an expert at monitoring for and recognizing these indicators and all crew members should be trained to take action. In geothermal drilling, in addition to being alert to the warning signs above, it is of prime importance to: monitor drilling fluid temperatures in and out while drilling; maintain a frequent and close analysis of the formation cuttings for a change in mineralization; and exert caution when drilling through formations where lost circulation zones are expected. Difficulties or abnormal conditions with any of these indications or procedures can also indicate a potential kick.

Even though geothermal wells most often are under-pressured (which typically causes lost circulation) the principal issues in geothermal well control usually involve unexpected steam or gas flow. This can be caused by drilling into a formation that is at much higher temperature or much higher pressure than predicted, as was the case with the blowout at Puna in 1991. The key to control is having adequate casing setting depths, which will permit shutting the well in as soon as a kick is detected. The BOP equipment

and alarms must be capable of sensing small volumes that trigger the rig crew to shut in the BOP before the maximum pressure limits of the wellbore and the wellhead equipment are reached

#### 5.4.2 Kick Control

Well-control procedures should be included in the well planning, so that the proper casing design is developed during the planning stage, the proper actions will be established and crews will be familiar with them when drilling begins. These well-control procedures should be posted on the rig, with available access for all personnel. It is essential that rig crews be trained to react quickly and appropriately to an unexpected event that might jeopardize the well.

While the likelihood of a well kicking at any time is real, the method of controlling such a kick is simple and effective. Steam is condensable, so by simply shutting in the BOPs and pumping cold water into the well (both down the drill pipe and down the annulus), the well can be quickly controlled (Hole, 2008b). During a steam kick, it is normal that some volume of non-condensable gas (predominantly CO<sub>2</sub>) will be evolved. After the steam fraction has been quenched and cooled, it is common practice that this small volume of non-condensable gas be bled from the well through the choke line. Some H<sub>2</sub>S gas may be present, usually in small quantities, so precautions are required, and any steam bled off should receive H<sub>2</sub>S abatement.

Several proven kick-killing methods have been developed over the years, based on the concept of constant bottom-hole pressure. Two of the most common methods are known as the "drillers" method and the "wait-and-weight" method. Rig personnel should be familiar with, and trained in, these procedures.

Selection of the method to be used in a particular kick situation should be made by an experienced, qualified drilling supervisor. The actual method used will depend on knowledgeable considerations of surface pressure, the type of influx, the time required to execute the procedure, the complexity of the procedure, the down-hole stresses that may be present or introduced, and available equipment.

#### *Shut-in (Kill) Procedures*

The severity of a kick depends on the volume and pressure of the formation fluid that is allowed to enter the hole. For this reason, it is desirable to shut the well in as quickly as possible. When one or more warning signs of a kick are observed, procedures should be started to shut in the well. If there is doubt as to whether a kick is occurring, shut in the well, and then check the pressures and other indicators.

Specific shut-in procedures when one or more kick warning signs are observed:

#### **While Drilling:**

- Pick up kelly until a tool joint is above the table.
- Shut down the mud pumps.
- Close the annular preventer.
- Notify the company supervisor.

- Record the build-up in drill-pipe-pressure and annular pressure.

**While Tripping:**

- Pick up kelly until a tool joint is above the table.
- Install the full-opening safety valve.
- Close the safety valve; close the annular preventer.
- Notify the company supervisor.
- Make up the kelly; open the safety valve.
- Record the build-up in drill-pipe-pressure and annular pressure.

**While Out of the Hole:**

- Close the well in immediately.
- Record the pressure build-up.
- Notify the company supervisor.
- Prepare for snubbing or stripping into the hole.

**While Using a Diverter:**

- Pick up kelly until a tool joint is above the table.
- Shut down the mud pumps.
- Open the diverter line valves.
- Close the annular preventer.
- Start pumping at a fast rate.
- Notify the company supervisor.

All of the above are suggested procedures, to be implemented by a knowledgeable drilling supervisor to suit the particular conditions existing at the time of the kick. See also *Drilling Fluid Condition and Circulation* in Section 5.6.3.

5.4.3 Post-Completion Blowout Prevention

It is important to realize that blowout risks are not restricted to the initial drilling and completion of a geothermal well. At a much lower incidence rate, blowouts can occur at producing wells and at shut-in idle wells, and the wellhead equipment needed to shut-in should be recognized as vulnerable to natural surface conditions and vandalism. The capacity, integrity, and security of geothermal wellhead equipment are all the responsibility of a production engineering expertise.

*Risks in Hawaii*

Two areas of subsurface risks to casing-string integrity in existing Hawaiian geothermal wells should be noted. The corrosion potential of wellbore fluids, in both the production and shut-in (static)

modes should be identified. Baseline chemistry and casing-evaluation procedures should be established shortly after well completion. The objectives here are to assure and prolong casing integrity, and to preclude any blowout consequent to a casing failure due to corrosion. Wells that have been tested or have produced high-temperature fluids, and then are shut-in for periods of time, particularly require regular and accurate monitoring of casing conditions. Temperature decreases imposed by the active Hawaiian ground water regime can accelerate H<sub>2</sub>S corrosion in shallow casing strings in idle wells. Finally, the risk of casing failure in rift zone eruptions and earthquakes (shallow fault movements, ground disruption or rotational failures) should be recognized.

Blowout prevention requirements during remedial work, re-drills, re-completions and abandonments, in all geothermal wells, must be evaluated and provided for by the same process of consideration required in every new permit proposal for geothermal well drilling.

#### 5.4.4 Blowout Prevention in Slim Holes

Much smaller volumes of drilling fluids are circulated in slim holes than in full-scale production holes. Kicks of any volume in slim holes are therefore of more consequence, and immediate detection of fluid entry, or lost circulation, is critical. Another feature of importance is the high annular pressure loss (APL) with respect to formation pressure that is incurred by drilling fluid circulation in slim holes, particularly when using continuous-coring drilling equipment with diamond-impregnated bits. The high rotary speeds (RPM) used to drill slim holes also add to the resulting overbalance while actively drilling or coring. This physical phenomenon relates to the very small annuli between drill tubulars and the rock wall. The high APL can be used advantageously to create a dynamic kill and control of formation-fluid entry by accelerating the pumping rate to maximum levels and circulating out the intruding fluids. In summary, blowout prevention in slim holes requires special training, precise flow metering, real-time data presentation and dynamic kill proficiency.

#### 5.5 Drilling Fluids and Geothermal Well Control

All reputable publications on blowout prevention stress the role of drilling fluids in minimizing, if not precluding, entries of normal- or high-pressured formation fluids into the wellbore during the active drilling process. This is achieved by circulating a weighted mud or drilling fluid, which creates an excess or overbalance of internal hydrostatic pressure on every square inch of the open wellbore.

The normal hydrostatic pressure gradient for the formation fluids in Hawaii rift zones should approximate 433 psi per 1,000 feet of vertical depth for fresh water and 442 psi per 1,000 feet for salt water (Patterson *et al*, 1994a). This range of pressure gradients may prevail over much of the KERZ in the deep geothermal zones, where several geothermal wells have been drilled through 2,500 foot intervals of hot (600-700°F) prospective rock interval by circulating fresh water as a wholly satisfactory drilling fluid. Well control was maintained confidently in these operations and, subsequently, these fresh-water-drilled intervals yielded proven geothermal fluids during flow tests following well completion. It should be noted that the greater cooling capacity of water, as compared with mud-rich drilling fluids, played a positive role in these achievements.

Cooling by the circulation of drilling fluid is an inherent physical process in geothermal well drilling. Where accelerated or optimized, the cooling process itself can be recognized as a well-control function. The efficient cooling of circulating drilling fluids particularly will require an adequate surface cooling



facility in the loop. Mud-cooling towers that allow the hot returning mud to fall in a baffle system against a cool air draft are a standard equipment option for geothermal drilling. It is important that mud-cooling towers be adequate for the heat load anticipated and that they be carefully maintained and monitored during use to assure that cooling is being effectively accomplished. Additionally, geothermal well control in Hawaiian rift zones requires ready access to an ample supply of cool water for wellbore circulation as a well-control option.

Both the specific KERZ drilling experience and the practice of worldwide geothermal drilling demonstrate a disinclination to drill with heavily weighted muds or saline solutions as a preferred means of well control. This follows from the expectation of drilling through fractures in the prospective hot zones which have much higher permeability and production potential than a bulk rock interval of some uniform primary (commonly lower) permeability. Fractures present the immediate risk of lost circulation and a possible well kick, particularly when over-pressured fracture fluids are released. The perceived benefits of significantly weighted drilling fluids (significant overbalance) are usually lost immediately in geothermal wells which successfully penetrate fractures. The loss of drilling fluid from the wellbore into formation fractures is accelerated in direct proportion to the overbalance due to excessively weighted mud. If, as indicated to date, blowout risks in Hawaiian rift zones are predominantly fracture-controlled and fracture-specific, it does not appear that excess weighting of drilling fluids will be a common means of blowout-risk reduction during future drilling in the rift zone environments.

#### 5.6 Drilling Monitoring

The actual drilling process on geothermal wells worldwide is commonly monitored with special concerns for rock penetration and drilling-rig performance (see also Section 3.5). Both the operator and the drilling contractor require a continuous stream of data on the rocks, formation liquids and gases, pressure, and temperatures being encountered by the drill bit. Mechanical and hydraulic parameters are recorded for every combination of hole size, drilling assembly and drilling-fluid circulation to help determine an optimal drilling penetration mode for each rock type.

Drilling-monitoring procedures can thus be defined as the continuous sensing actions that identify the subsurface conditions in the rock formation and in the wellbore as the drill bit advances. Although geothermal operators commonly provide for some level of monitoring when they drill most wells, all types of monitoring incur additional costs that may limit the selection of specific procedures, and most operators choose specific procedures in the context of what is known and not known about the subsurface environment to be penetrated by the wellbore.

Drilling-monitoring procedures play an important role in the blowout-prevention strategy that must be established by every operator. All of the products of the adopted monitoring procedures (see also Section 5.6.2) should be carefully integrated and assessed in making a confirmed or revised selection of the production casing setting depth. Isolation of the production or injection zone within the geothermal reservoir is commonly intended, but may not be achieved in the context of the down-hole conditions actually encountered. Additionally, the drilling-monitoring products should be closely examined for details that may enhance the completion design or procedure for the successful well. For example, longer or shorter perforated-liner intervals may be appropriate to the actual completion-zone features found, rather than as stipulated in the written drilling program.

Perturbations of critical data that may reveal the degree and/or immediacy of a blowout risk are usually first observed by certain key personnel (see also Section 5.6.3). For example:

- **The Driller:** Exercising personal control of drill bit performance in making hole, the driller is the first person to sense a change at the bottom of the wellbore. Additionally, drillers must have an accurate, real-time knowledge of the drilling-fluid upflow in the annulus between drill pipe and the wall of the open hole. Gain or loss departures from 100% of the drilling fluid pumped down the drill pipe and through the bit orifices are critical indicators that, alone or with other corroborating information, signal a disruption of a normal drilling mode. The mud pits are monitored closely for any additions or losses of drilling fluids as they circulate through the drilling system (Figure 5.7).
- **The Mud Logger:** The mud logger continuously surveys the changing rock features, formation fluids, temperature variations reflected in the returning drilling fluid and other drilling parameters, recording the data on the mud log (Figure 5.8). The mud logger is the first to evaluate the mineralogical changes in the formation, as well as gas and liquid entries that may signal the penetration of high-temperature, high-pressure conditions.

A comprehensive overview of drilling progress and certain monitoring parameters can be made available on the rig floor and at any other location (including off-site) with the use of a real-time drilling system (Figure 5.9). This system measures and records the drilling RPM, pressure, temperature, pump strokes, weight on bit, depth and torque on the drill string. Sudden changes in these parameters are shown in real time and can be monitored for steam or fluid entries or losses.

It is essential that drillers and mud loggers have reliable, instantly available electrical communication between their work stations if monitoring procedures are to more effectively contribute to the reduction of blowout risks. These simple procedures are intended to eliminate a common problem: too often a key piece of new information is received, but is not properly read, understood or communicated. Operators of Hawaiian geothermal drilling projects need to assure that a high level of cooperation in comprehending the norm and the upset hole conditions are practiced together by the contracted drillers and mud loggers.

There was a blowout incident at KERZ well KS-8 in 1991 (see Section 5.6.1) that followed a failure to heed upset hole conditions, and experience from that event indicates that such incidents should be avoidable, contingent upon the accurate interpretation of monitoring data and decisions made based on these data. The operator's drilling engineer and geologist, having designed both the drilling program and the well-control program, should establish and maintain active communications with the key specialists throughout the drilling process. In prospective Hawaiian rift zones, the operator can better thus identify the potential for hot and over-pressured fault and fracture conduits, and can better prepare for penetration of such conduits and reduce the impacts of kicks and lost circulation. Alternatively, the operator can make the decision on whether or not to set casing, particularly if a long open-hole section is exposed above the interval of concern.

#### 5.6.1 Monitoring Rationale in Hawaii

As elsewhere, geothermal wells drilled in the active volcanic rift zones of Hawaii merit carefully planned and integrated monitoring procedures. This view is supported by two primary concerns:

- In spite of experience from drilling some 26 wells in the KERZ, the subsurface geology, hydrology, temperatures and pressures in the rock roof above the deep magma conduits that create the rift zone are too complex to be perfectly predicted in a new well or even while re-drilling an old one.
- Two geothermal wells (KS-7 and -8) have demonstrated that fault or fracture conduits, charged with high-pressure, high-temperature fluids, can extend upward to relatively shallow depths from a deeper subsurface domain of >600°F temperatures. These near-vertical and planar conduits present both blowout risks and significant geothermal energy production potential. Geothermal drilling requires the evaluation and more effective utilization of monitoring procedures as a supplemental strategy for blowout prevention.

For example, the publicly released Independent Technical Investigation of the June 1991 KS-8 blowout reported at 3,401 feet depth while drilling: a bottom-hole temperature (BHT) increase, significant CO<sub>2</sub> and H<sub>2</sub>S gas entry, drilling-fluid gain, and minor well flow (Patterson *et al*, 1994b). Seventy-five feet deeper, the drill bit entered a major void (between 3,476 and 3,488 feet) that promptly resulted in a blowout when the mud column drained from the wellbore. It can be expected that the KS-8 mud log and other monitoring records contain additional evidence of an impending major upset, and the KS-8 well record indicates that competent geologic-engineering teams should be able monitor these data and make effective and safe production-casing settings above such exceptional completion targets. (KS-8 later was briefly used for production at a 10-MW level, but then plugged and abandoned due to suspected casing damage; see Table 1.1).

#### 5.6.2 Categories of Monitoring Data

Drilling monitoring for the detection and prevention of blowouts focuses on four vital data sectors:

- Physical properties and resource potential of the newly penetrated rock formation. The array of information gathered in this sector is commonly presented in a continuous "mud log" graphic record over the entire interval drilled. The mud log includes, but is not limited to, the continuous and automatic analysis of formation gases such as methane, carbon dioxide and hydrogen sulfide, fluid losses, drilling depth, as well as the geologist's description of the lithology and associated alteration minerals at various depths.
- Drilling penetration rate and drill bit performance measurements. The rate of penetration (ROP), commonly measured and recorded in feet per hour, indicates the mechanical progress of drilling in the host rock. Weight on bit, rotational speed and torque are additional measurements that are made to better understand the variations of the drilling penetration rate.
- Drilling fluid circulation in the wellbore. Drilling fluid clears the newly made hole of drilled rock debris, and cools and lubricates the rotating bit and drilling string. Importantly, the density and hydrostatic pressure gradient of the drilling fluid are commonly used to control the formation fluids and pressures encountered. Drilling fluid losses and gains, as well as fluid temperature in and out of the wellbore, are of special significance as forewarnings of upset conditions (see Figure 5.7).
- Leakoff testing (LOT) is used to determine the strength or fracture pressure of the open formation and is typically conducted immediately after drilling has advanced below a new casing shoe. The

well is shut in and fluid is pumped into the wellbore to gradually increase the down-hole pressure. When the formation pressure is exceeded, the drilling fluid will enter the formation, or leak off, either moving through natural permeable pathways or by hydraulically fracturing the rock to create new pathways. The results of the LOT dictate the maximum pressure or mud weight that may be applied to the well during drilling operations (typical operations set a limit of 50-100 psi below this level as a safety factor). The data obtained from LOTs conducted in several offset wells can aid in designing the casing depths of future wells.

The information from these sectors has important potential applications in addition to blowout prevention. For example:

- Possible immediate improvements in drilling procedures, drilling fluid properties or even the casing plan to adjust to changing down-hole conditions.
- Enhanced well designs, drilling programs and/or cost reductions for future wells in the field.

### 5.6.3 Monitoring for Blowout Prevention

Monitoring procedures for blowout risk reduction typically fall into one of five categories. The sequence of categories below falls in approximate order of importance when examined with the assumption that the sudden encounter of high pressured geothermal fluids in fractures constitutes the primary blowout hazard in a volcanic rift zone (Patterson *et al.*, 1994a).

#### *Bottom-Hole Temperature Variation*

Blowout hazards in Hawaiian rift zones have a strong correlation with high subsurface temperatures. There was a common working impression before the KS-7 and -8 blowout events that 600°F+ temperatures were present only below 4,000 feet in the Kapoho-State geothermal leaseholds, and at even greater depths further up-rift to the southwest in the KERZ. These wells respectively vented 500°F fluids from below 1,400 feet and 620°F from below 3,476 feet in uncontrolled flows at the wellheads. The BHT cannot be measured in the active drilling process because of the cooling induced by the drilling fluid circulating around the rotating bit.

On the other hand, the exit (outflow) temperature of the drilling fluid vented at the wellhead to the mud pit is continuously recorded. Sharp increases of outflow temperature with depth are the telling indicators for BHT variations and can be immediately read by the mud logger in the context of the complete temperature profile (surface to current depth) to detect possible correlations with events on other indices. With respect to blowout-risk reduction, neither an existing BHT value nor any specific high-temperature value has primary importance. Rather, it is sharply rising temperatures, coincident with other dynamic events observed in an integrated monitoring procedure, that are to be taken as a caution or evidence that a blowout threshold is being approached.

#### *Rate of Penetration (ROP)*

Variations in the drilling ROP commonly reflect rock conditions encountered by the drill bit, provided other drilling parameters such as weight-on-bit (WOB), rotational speed and torque remain uniform, or their coincident variations are understood. An increase of ROP (a drilling break) can indicate a permeable interval containing formation fluids where the fractured rock can cause sudden erratic

perturbations in all these mechanical drilling indices. Major fractures previously encountered in the KERZ have allowed the drilling assembly to free fall into open voids. At shallower levels, the rubbly, scoria-filled intervals between lava flows (more-likely sealed at the reservoir level by hydrothermal alteration products and overburden pressure) can also present drilling breaks that are particularly troublesome during core-drilling but also can be difficult during rotational drilling.

The consequences of a major fracture encounter are frequently immediate. Competent drillers will quickly determine the status of their drilling fluid return flow in appraising the situation and apply an appropriate response, if required. Increases in ROP coincident with the penetration of a high-pressure zone have been attributed to bits drilling faster in underbalanced mud weights in some blowout prevention treatises (Patterson *et al.*, 1994a). One prudent option when drilling into fractured, high-temperature intervals, especially with initial formation fluid entries identified in the return drilling fluid, is to deliberately reduce the ROP (or briefly hold in a full circulation mode) to confirm the drilling fluid system status and to observe more of the impact of the formation fluids encountered.

#### *Drilling Fluid Condition and Circulation*

Accurate knowledge of the drilling fluid condition, particularly its density in pounds per gallon (lbs/gal) and its function in the wellbore, is critical to drilling with effective well control. Any departure (positive or negative) from a 100% return of the pumped circulating volume delivered through the drill pipe to the drill bit needs to be promptly evaluated as to magnitude and meaning. Continuous measurement and recording of the drilling fluid gain, loss, or full return is made in specific tanks (mud pits) included in the fluid circulation loop (see Figure 5.7). Either a gain or loss of drilling fluid must be taken as a warning of increasing blowout risk potential.

A gain is a reliable indicator of formation fluid entry into the wellbore (a kick). Responses to a kick were presented in Section 5.4.2; basically, If well flow is indicated or suspected following a gain, drilling should be halted, the kelly pulled above the rotary table, the mud pump shut down and the exit flow line visually examined for possible flow. If the well is flowing under these circumstances, the annular preventer should be closed to identify pressure buildups on both annulus and drill pipe. When stable, these pressures can determine the adjustments in mud weight and wellbore hydrostatic pressure necessary to balance the formation fluid inflow. An evaluation of the option of circulating cool water in the wellbore should be made if the kick is associated with a temperature increase.

Partial or complete loss of drilling fluid returns is the more common problem consequent to fracture penetration. Complete loss of circulation, followed by a rapid falling fluid level in the wellbore annulus is a most likely trigger for a blowout event. Drilling must be halted, the drilling string pulled up (only to the first drill pipe tool joint) and the preventer closed until the situation is evaluated and a response determined.

#### *Tripping the Drill String*

A special note should be made of drilling fluid monitoring requirements while tripping the drilling string (removing it from the hole for some reason, usually to install a new bit). Frequently in geothermal well drilling with mud and water, the hydrostatic pressure of the fluid has only a moderate overbalance on the formation fluids. This is further reduced with the cessation of circulation immediately before pulling the drill string. In hot, prospective rock zones, the large-diameter drilling assembly moving up-hole can

swab, or pull, formation fluids into the borehole, because there is a reduction of the hydrostatic pressure below the bit. The greatest danger of swabbing occurs when pulling the first few stands of drill pipe (drilling assembly just pulling off bottom). At this point, a careful confirmation of the drilling fluid fill-up volume, required to hold the fluid level at the wellhead, is essential. If the well fill-up volume is less than the volume of drill pipe pulled, swabbing should be inferred, the bit returned to the bottom and the hole recirculated to clear the formation fluids from the well. In summary, swabbing is a mechanism that can and has caused blowouts. Slower pulling of the initial stands and the fill-up check are the defensive procedures to use.

#### *Formation Fluid Entry*

Most (not all) geothermal fluid-bearing zones, both high- and normally-pressured, will be first identified by a change of the drill bit penetration rate, with a partial or complete loss of circulation or a subsequent change of gases into the drilling fluid upflow in the annulus. Mud logging systems will automatically measure and record an increase in carbon dioxide, hydrogen sulfide, methane and ethanol in parts per million (ppm) whenever the drilling fluid is being circulated. Although this information has a time lag compared to the immediacy of a drilling break, it is the most positive specific indicator (aside from a kick) that geothermal fluids have been encountered. Gas-cut drilling fluid returns coupled with temperature increases are a clear warning that a high pressure zone of considerable flow potential may have been encountered. With additional penetration, geothermal formation liquid fractions may (not always) cause detectable salinity increases in the return drilling fluid. Salinity measurements using conductivity are not an automated monitoring procedure, but are optionally performed by the mud logger in evaluating fluid entry events.

#### *Secondary Mineralization*

Geothermal-fluid-bearing faults, fractures and zones are frequently lined by a sheath or seal of secondary minerals that have been deposited over or replaced the original rock minerals that line the conduits (hydrothermal alteration products). Secondary minerals are continuously identified and recorded in geothermal mud logging with the intent of discerning, in correlation with the wellbore temperature profile and other data, the most prospective intervals for fluid production. Logic would suggest that the larger hot fluid conduits, which present both significant production potential and blowout risk, would likely have a thicker sheath of secondary minerals. The extent to which this prevails in the Hawaiian rift zones and to which it may be a particular precursor to high pressured geothermal fluids in fractures has not been published in any detail. Natural variations in the secondary mineralization process can be extreme, so any secondary minerals detected can presage either fluid-filled fractures or zones that are completely sealed by mineralization, particularly in the KERZ domain of active faulting and fracturing. Whatever may be the present view of this apparent index among Hawaiian geothermal operators, it appears to merit careful evaluation within the concept of integrated monitoring as a logical part of blowout prevention strategy.

#### *Drilling with Air, Aerated Liquids, or Foam*

These drilling fluids are utilized in the underbalanced drilling option, which is often employed in geothermal drilling particularly in known vapor-dominated reservoirs. (The pressure gradient in such a reservoir is determined by the density of steam and not that of water.) Drilling with air or aerated liquids normally requires substantial additional equipment and service requirements (*e.g.*, air compressors, rotating head, banjo box, blooie line, drilling muffler and H<sub>2</sub>S abatement backup). As mud-based drilling

practices have been the standard in the KERZ, air drilling has been previously employed on just one geothermal exploration well in the area (according to publicly available data; Patterson *et al.*, 1994a). In 2010, however, PGV successfully drilled the 26-inch section of well KS-14 with aerated fluids in comparatively less time than an offset reference well (KS-6) (Rickard *et al.*, 2011a).

It is expected that air and aerated fluids drilling will be used and further evaluated in the future in the Hawaii environment. Air drilling eases the driller's concern with circulated fluid controls on formation fluids; the formation fluids, with relatively unrestrained entry to the annulus, are transported to the surface and through the drilling muffler for chemical and noise abatement before release to the atmosphere. The mud logger's interpretation of rock and mineral cuttings is degraded somewhat by the much reduced rock particle size produced by air drilling. Otherwise the drilling monitoring procedures discussed above will apply for the same objective of blowout risk reduction.

#### *Summary*

In summary, operators have adequate monitoring procedures at hand to reduce blowout risks. The driller's main focus is on immediate deviations from the controlled drilling process and the mud logger's main focus is on subsurface physical consequences of borehole advancement. Blowouts are commonly preceded by multiple warning signs of increasing risks. Accurate recognition of such risks and quick action to control or reduce them with the drilling monitoring procedures discussed here.

#### 5.7 Supervision and Training

The major cause of most blowouts is human error; either none of the crew or the operator's advisors recognizes an existing well control problem, or steps to control the situation are not performed soon enough. Most blowouts are fully preventable by properly trained drilling personnel. Thus, proper training of the crew is as important to successful well control as is the proper selection and use of blowout prevention equipment, as discussed in the preceding sections. The Hawaii conditions for geothermal drilling require that every operator recognize its prime responsibilities to provide supervision and training that is several levels above the industry average.

There must be a proper balance between practical, on-the-job-training, operational drills and formal study for a wide range of individual experience levels. In a few cases, drilling and monitoring crews will have worked together closely in other geothermal areas, some of which may exhibit well control challenges similar to Hawaii's. In other instances, crews will comprise a mixture of individuals who have not worked as a team before, and may have a larger percentage of new workers, especially at lower skill levels in the drilling and production jobs.

An additional consideration in the Hawaii case is known occurrences of relatively high levels of H<sub>2</sub>S gas in the geothermal resource compared to levels found elsewhere. Proper well planning and equipment selection can mitigate many of the hazards of H<sub>2</sub>S drilling in the well control sense, but it is necessary that all drilling crews have a clear understanding of the dangers and rules that accompany drilling in known H<sub>2</sub>S zones.

#### *Supervisory Experience*

Although complete training for specific crews that will drill in Hawaii's geothermal zones is of primary importance, the art of well control is not learned from classroom training alone. Therefore, experienced

supervisory personnel are vital to the process of training the drilling crews, as well as in lending their experiences to the ongoing supervision of the drilling. Drilling plans submitted in Hawaii should discuss the levels of experience of the drilling crews, supervisors, consultants and managers, with comment on the methods to be taken to ensure that such experienced persons will be directly involved while drilling activities are underway.

#### *Drilling Team Training and Drills*

The training of drilling teams, including supervisory, management and operating personnel, in well control and blowout protection can be discussed at three basic levels:

- Level one: training through formal courses that are infrequently offered by industry and regulatory organizations, often at a regional or national level;
- Level two: the training that an operator or drilling company conducts on a more or less formal basis with its drilling supervisors, drilling crews, and others who directly support drilling operations;
- Level three: operators must have a program of drills that ensure all personnel actually have 'hands-on' experience with the installed blowout prevention equipment.

A number of organizations conduct training and certification in well control, mainly directed toward the petroleum drilling industry, but training focused on geothermal drilling is increasingly available.

In addition to formal training and periodic updates as drill crews may shift or the drilling may enter new phases, blowout prevention drills should be conducted on a regular (but unannounced) basis to provide further training, and to keep crews focused on the possibilities of well kicks, and blowouts. Crews should be familiar with the equipment in use, and be able to properly and safely shut in the well before a control problem becomes dangerous to personnel or the well itself. These drills should be directed at well control and proper blowout prevention procedures in three basic situations - when drilling ahead, when 'tripping out' of the well, and when the drill pipe is out of the wellbore.

Operators should outline their formal training proposed for drilling personnel, with specific references to 'kick' recognition and blowout prevention, including monitoring systems, equipment, and drilling procedures in the well control program. Subjects covered should include new employee orientation, visitor briefings and general safety training. Formal training sessions, regular review training and blowout prevention drills held should be noted in the daily reports of the drilling operation.



## 6. WELL COMPLETION AND TESTING

### SUMMARY

- 6.1 Testing Objectives: Purposes and types of well testing.
- 6.2 Testing Mode: Well testing methods (static, production, injection).
- 6.3 Testing Duration: Testing lengths and objectives.
- 6.4 Testing Techniques: Various testing techniques and their uses.

## 6.1 Testing Objectives

At the end of drilling, testing is required to guide completion of the well and to assess its potential utility. Such testing has several objectives:

- **Use of rig:** The most immediate objective is to decide whether the drilling rig can be released, or whether further rig work is required (such as a deepening, a re-drill to a different down-hole location, or installation of a liner). Continuing rig operations is expensive, but it is even more expensive to release the rig prematurely and have to re-mobilize it later. This decision typically requires some form of short “rig test” (see Section 6.3). Sometimes this involves flowing the well, but at other times or other locations (e.g. due to a limited capacity to store the fluids produced or due to regulations about discharge) it involves injecting into the well.
- **Well characterization:** The focus is to determine the properties of the well. Some such properties can be measured or approximated by a rig test, but full characterization usually requires testing for several days at least, after the rig is released (sometimes several weeks later, to allow the well to recover from the cooling caused by drilling).
  - Key parameters for production include flow rate and corresponding wellhead pressure, temperature, pressure, enthalpy (heat content), and chemical composition of the produced fluids, as well as an estimated equivalent megawatt (MW) rating.
  - For injection wells, a key parameter is the well’s capacity to accept injected fluids and the relationship between wellhead pressure and injection rate.
  - For wells completed within the reservoir (slim holes or full-diameter wells), well characterization also includes measurement of formation properties near the wellbore, such as the permeability-thickness product (kh) and skin factor (s) – such properties are usually deduced from pressure transients associated with changing the rates of production or injection.
  - For wells completed above the reservoir, such as temperature-gradient wells, the key parameter is simply the temperature profile (and water level, if it can be determined). The stable profile can only be obtained some days or weeks after drilling.
  - For all wells, the well characterization should include sufficient information to assess the mechanical integrity of the well completion; this is typically established by various forms of pressure testing and casing inspection logs.
- **Reservoir characterization:** The focus of testing for reservoir characterization is to determine how wells interact with each other and how the reservoir performance is likely to change with time. This typically involves multi-well testing; that is, the simultaneous or partly overlapping testing of two or more wells (for example, production from two wells and injection into a third), for a total testing period of several weeks to several months after a certain amount of information is already available from testing on a well-by-well basis (see also Section 6.3). Multi-well testing is important in deciding on a long-term production-injection strategy for the project and in projecting requirements for make-up drilling in the future.
- **Plant design:** This is an important objective of all well testing, and it becomes progressively more rigorous as the characterization of the wells and of the reservoir proceeds. Early in the

development program, well test results are used to assess what type of plant technology is best suited for the resource (for instance, a flash or binary plant). As information becomes available about the capacities of wells for production or injection, decisions can be made about what the MW capacity of the plant should be. Once reliable chemical data become available (preferably from repeat measurements on several wells), specific decisions can be made about the hardware and processes to control scaling, corrosion, and atmospheric emissions of non-condensable gas (NCG).

## 6.2 Testing Modes

There are three modes of testing geothermal wells, each applied in specific situations:

- **Static tests:** These are tests conducted with the well in static condition; that is, neither producing nor injecting fluid. Principally, this comprises wireline surveys, which involve running sensors into a well to record desired parameters (such as temperature or pressures) as a function of depth and time. Different types of wireline logging are discussed further in the section on testing techniques (below). It is also possible to collect down-hole samples of wellbore fluids using a sampling device run on a wireline, though it may be difficult to obtain samples representative of particular zones due to contamination by drilling fluids and circulation within the wellbore.

In some cases, it may be possible to conclude based on static testing alone whether a given prospect area warrants further investment. For example, a highly negative result of several temperature-gradient wells: while this result would be disappointing to the developer, it would allow exploration to focus elsewhere with minimal environmental consequences at the evaluated site.

- **Production tests:** This involves flowing the well to assess its productive characteristics. Many wells will self-flow, especially if the resource temperature is high, but wells can also be tested by installing pumps down-hole, subject to pump temperature limitations (currently about 360 – 370°F) and other factors.
  - Usually, the test discharge is to atmospheric pressure and if the temperature of the produced fluid is above the boiling point, the fluid will flash to a two-phase mixture of steam and water. Less commonly, the discharge is directed into a pressurized vessel (“production separator”) for the steam-water separation.
  - The steam is released to the atmosphere, after abatement of any hydrogen sulfide (H<sub>2</sub>S) to comply with applicable air emissions limits, as well as appropriate baffling to avoid excessive noise.
  - The water (often referred to as “brine,” although its salinity is usually less than seawater) is discharged to a holding pond (or “sump”) near the wellhead. From the sump, the water is typically either pumped to another well for injection, or it is injected back into the source well at the end of the test.
  - Injection must comply with any necessary permits, and the receiving zone for the injected water should either be the geothermal reservoir itself or another zone containing water of lower quality than what is being injected.

- Lower-temperature resources may yield fluids that are not hot enough for electricity generation, but that may be of interest for direct-use applications. If the wellhead temperature is below the boiling point at atmospheric conditions, there would be no venting of steam, and only the produced geothermal water would require disposal as described above.

Production tests yield information that cannot practically be obtained in any other way, such as the chemical composition of the fluids produced and the effect of production on other wells in the geothermal reservoir. Production tests are commonly performed in geothermal fields around the world, with appropriate measures for local restrictions on such factors as emissions, injection and noise abatement.

Historically, production tests in the Kilauea East Rift Zone (KERZ) have been conducted on wells that flow on their own, and the use of atmospheric venting has been minimized in recent years, in part because it has been possible to evaluate wells on test by directing flow to the existing power plant.

For geothermal resources in other areas of Hawaii (or for new projects in the KERZ with no connection to the Puna project), it is to be anticipated that production testing of new wells will be a necessary component exploration and development.

- Injection tests: These involve injecting into a well to assess its capacity to accept water. This may be water from a shallow groundwater well or some other external source off-site, or brine from the production test of another well. Injection testing allows measurement of certain formation properties (such as the permeability-thickness product and the skin factor from pressure-transient testing). Wireline logs conducted during injection can indicate the proportions of injected water going into specific reservoir zones.

It is even possible to use injection test data to make an estimate of the production capacity of a well, although such estimates are significantly less reliable than a direct production test, and they can lead to incorrect planning decisions about the number of wells required or the size of the power plant that the reservoir can support.

Injection tests do not allow collecting representative samples of the reservoir fluids, which can vary significantly from well to well. The lack of chemical information means that scaling and corrosion potential are not measured and increases the risk of inappropriate designs for the surface facilities (separators, pipelines, power plant).

### 6.3 Testing Duration

The duration of a geothermal well test depends on the stage of project development and the type of information that is being sought. For the purposes of this drilling guide, the duration of testing can be described under three categories: completion tests, short-term tests, and long-term tests.

- Completion tests (“rig tests”): As the name implies, this category comprises tests conducted at the completion of drilling. Such tests are primarily intended to inform the decision about the use of the rig. They take place while the rig is still on the well, and can include testing in all three modes (static, production, or injection). Certain types of wireline logging (such as open-hole geophysical logs) are almost exclusively conducted during completion testing, because the

logging tools can only be run while the well has been cooled by drilling operations (and sometimes even with active cooling by circulating the well) or prior to the installation of a liner through the reservoir interval. (Wireline logs may also be run at intermediate casing points, before casing is installed.)

Production or injection tests during completion are usually of short duration (typically less than 24 hours), in large part because conducting any operation with the drilling rig in place (not yet released) is quite expensive. The information from completion testing is preliminary at best, but it is usually sufficient to decide the important question of whether to rig down or continue with further drilling operations.

- Short-term tests: The focus of short term testing is primarily a complete characterization of the newly drilled well, rather than characterization of the reservoir overall even though some information on well interactions may be obtained. Stabilizing the enthalpy and flow rate at a two-phase geothermal well typically requires up to 10 days of flow, so this duration is suggested (somewhat arbitrarily) as the upper limit for short-term testing for the purposes of this drilling guide.
  - If a production test lasts long enough to allow the well to stabilize at several different flow rates, then the discharge characteristics of the well can be characterized by a plot of wellhead pressure versus stabilized flow rate (a “deliverability curve”). This can be very useful in allocating flow among production wells when the project goes online.
  - If the well is tested by production, the test also allows the well to clean up; that is, to produce back some portion of the drilling mud and cuttings that may have been lost to the reservoir zone during drilling. The duration of 10 days also allows sufficient time for repeat sampling of produced fluids to verify chemical stability. Samples taken after several days of flow can be representative of uncontaminated fluids in the geothermal reservoir, but in extreme cases of drilling with water and no circulation returns (which is possible in some highly-permeable formations in young volcanic rocks, e.g. in the Philippines), a new well can flow for several months before being chemically stable, even though the contaminated fluids have been heated by surrounding rocks to reservoir temperature.
  - For an injection test the duration will typically be less than 10 days, due to the difficulty of providing sufficient injection water from a non-geothermal source – unless the injection test is being conducted in conjunction with the short-term production test of another geothermal well.
- Long-term tests: The focus of long-term testing is primarily on reservoir characterization, as described above in the section on Testing Objectives. Defining interactions between wells can take weeks or months, especially if techniques such as inter-well tracer tests are involved (that is, measuring the transits of chemical tracers through the reservoir from injection wells to production wells). The information from long-term, multi-well testing can be very valuable in improving the choice of a production/injection strategy and refining the design of surface facilities.

- Due to cost considerations, long-term testing prior to plant start-up seldom extends over three months. For the purposes of this drilling guide, the duration of long-term testing can be considered to be anything over 10 days.

#### 6.4 Testing Techniques

The techniques of well testing employed on specific projects will depend on resource characteristics and the preferences of the developer. The following list describes a number of commonly applied techniques, but the list is not intended to be exhaustive, and not all the techniques listed will necessarily apply to specific projects.

##### *Wireline and Geophysical Logging*

The most common form of geothermal wireline logging (lowering recording instruments into a well at the end of a thick, flexible wire) is the temperature-pressure (TP or T/P) log.

This log is sometimes supplemented by adding a spinner sensor to the logging tool, such that it records the velocity and direction of fluid movement at the same time as measuring the temperature and pressure, yielding a temperature-pressure-spinner (TPS or T/P/S) log.

Successive TP or TPS logs in a static well just completed can document the heating-up process after drilling, and often can provide indications of cross-flow between zones (even though the well is neither producing nor injecting at the surface). During production or injection tests, TP and TPS logs can yield important insights into which zones are contributing to flow or accepting injection.

During completion testing, some operators also run geophysical logs, which measure various properties of the formation (such as electrical resistivity, acoustic velocity, natural radioactivity) to provide insight into permeability and structure. Some geophysical logging tools are run at the end of a wireline, but many are run at the end of an electric cable.

Fracture-identification logs are a specific sub-set of geophysical logs that can identify the aperture and orientation of fractures and other permeable structures that can control flow into and out of the wellbore.

Geophysical logs can be especially important on the first wells in a new prospect area, in order to gain insight into geologic structure. However, due to the temperature limitations of the tools (as well as the expense of extending rig operations at the time of completion testing), many operators forego geophysical logging and place their primary reliance on TP or TPS logging for insights into characteristics of the geothermal zones.

For assessments of the mechanical condition of the wellbore, other wireline tools can be used as needed, such as caliper logs (to identify zones of scaling, corrosion of the casing and other casing damage), cement-bond logs (to assess the integrity of cement behind the casing), and borehole cameras (that can provide visual images of the condition of the wellbore wall).

##### *Flow Tests to Atmosphere*

Prior to plant construction, all forms of production testing for wells that produce two-phase flow (mixtures of steam and hot water) entail venting of steam to the atmosphere. The flow rates can be continuously measured by two-phase metering devices (such as critical-flow tubes, also known as “James

tubes”) or by separators that allow separate single-phase measurements of the steam and liquid phases. Critical flow tubes are vented to a muffler at atmospheric pressure; the steam exits the top of the muffler and the effectiveness of noise abatement depends on the design of the muffler. The water that exits the bottom of the muffler is directed through a weir box to measure flow rate. If a separator is used that operates above atmospheric pressure, the separated steam is still vented, but it can be directed to a rock-muffler to assist with noise control.

If the flow test is taking place during completion testing (that is, with the rig on the well), and the well does not flow on its own, flow can usually be initiated by injecting air down-hole through the drill string (an “air lift”).

After release of the drilling rig, if a shut-in well builds positive wellhead pressure on its own, initiation of flow can be accomplished by simply opening the wellhead valve to the metering equipment. For other wells, initiation of flow may require bringing an air compressor on-site and pressurizing the wellhead (creating an “air cap” down-hole) to depress the water level in the well: when the pressure is released after a heat-up period, the water may boil sufficiently to allow the well to flow.

If a flow test is desired on a well that does not flow on its own and the resource temperature is not too high, it can also be possible to induce flow by installing a down-hole pump; this technique has not been used in the high-temperature resources of the KERZ, but may be applicable if lower temperature resources are developed elsewhere in Hawaii.

#### *Injection Tests*

Any geothermal power plant requires not just production wells but also injection wells in order to operate. Injection testing can be performed to assess the permeability of wells that are expected to be used for injection in the long term. In a situation where flow testing to atmosphere is not possible (either for logistical or environmental reasons), a rough estimate of a well’s productive capacity can be inferred from injection testing. Injection tests are typically conducted at a sequence of rates, with measurement of corresponding pressures at the wellhead and down-hole. The injectivity of the well can then be expressed as an Injectivity Index (II), which expresses the change in injection rate that can be achieved by a change in injection pressure. Injection tests also can be interpreted by more sophisticated forms of pressure-transient analysis, as discussed in the following section.

#### *Pressure-Transient Tests*

Pressure-transient tests assess the permeability of the formation. When rates of production or injection change (such as when a well starts or stops flowing or the flow rate is changed), pressure pulses or “transients” are propagated through the reservoir and the transient test typically measures the build-up or die-off of the transient in the same well using pressure instruments installed at the wellhead or lowered down-hole.

The timing and magnitude of these transients can provide insight into the permeability of the formation; that is, the ability of the rock to transmit fluid. Pressure-transient analysis typically yields results that express permeability in terms of a permeability-thickness product (kh) and skin factor (s).

High-temperature geothermal systems often include steam-saturated portions of the reservoir (a “steam cap”) that significantly increase the compressibility of fluids in the reservoir and make it difficult to

quantitatively assess the pressure transients that correspond to well production. In such situations, because injection tests are conducted with single-phase liquid, the pressure responses to injection are often more amenable to pressure-transient analysis.

Pressure-transient tests also encompass interpreting reservoir pressures measured in observation wells, which can provide important insights about the amount of pressure support for the system and how the reservoir can be expected to perform over time.

#### *Tracer-Dilution Tests*

Tracer-dilution testing (TDT) is a technique that measures the simultaneous flow rates of steam and hot water in a single 2-phase flow line. The technique is also referred to as Tracer Flow Testing (TFT). It entails injecting vapor-phase and liquid-phase tracers at known rates into the flow line and sampling for these tracers downstream. Because the tracers partition into the vapor and liquid phases, measuring their concentrations at a known sampling pressure allows calculation of the steam and liquid flow rates, and by extension, the steam fraction and enthalpy of the two-phase flow stream. The technique provides a point-in-time determination of these parameters (rather than a continuous measurement). The TFT technique can be useful as a cross-check on continuous forms of two-phase flow measurement (such as critical-flow tubes or separators, as discussed above), or if the continuous forms of measurement are not available, repeated TFT measurements can be used to track changes in steam fraction and enthalpy over time.

#### *Inter-well (Reservoir) Tracer Tests*

Inter-well tracer tests evaluate the connection between injection wells and producing wells within the reservoir. The technique involves adding chemical tracers to the water going into injection wells and sampling for the presence of these tracers over time in production wells located elsewhere in the field. Some degree of connection between injectors and producers can be beneficial by providing pressure support to the reservoir. Too direct a communication may indicate a potential problem with cooling, as the fluids do not have a long enough travel time to allow for proper heating. Analysis of tracer data allows the configuration of production and injection in the field to be optimized, and assists in the calibration of reservoir numerical simulation models.



## 7. MONITORING AND REPORTING

### SUMMARY

- 7.1 Monitoring of Well Integrity and System Performance: Well monitoring program considerations and the data types collected.
- 7.2 Well and Surface Equipment Maintenance: Regulations and standard practices for down-hole monitoring, wellhead and surface monitoring, and facilities monitoring.
- 7.3 Well Records and Reporting: Types of records and reports required by law in Hawaii.

## 7.1 Monitoring of Well Integrity and System Performance

As an integral part of any reservoir exploitation project a monitoring system is set up to record information about certain parameters (such as the fluid produced and injected), so as to obtain a long-term view of the physical and chemical changes that occur in the reservoir, maintain the integrity of the wells and ultimately secure reservoir longevity and sustainable system operations.

Good maintenance practices minimize mechanical problems with wells and plant equipment and also enable efficient reservoir management to maximize the life of the resource and prevent premature degradation. It should be noted that some decline in well performance is normal and expected for geothermal fields. Make-up wells are typically drilled to compensate for this.

Production-injection monitoring systems typically record various parameters continuously (especially temperatures, pressures and flow rates), using electronic sensors installed at the wellhead, pump, or down-hole and these measurements are typically transmitted to a control room and compiled into a database. Other parameters are measured less-frequently yet are equally important, such as the data obtained during routine well tests of the types discussed in Chapter 6, chemical sampling and results of down-hole logging.

A detailed monitoring program should be developed for each well upon its completion, taking into account any problems encountered during drilling of the well, the reservoir conditions, reservoir conditions unique to the field, proximity of existing wells in the field, and the availability of appropriate monitoring equipment.

The key data categories and their sources for effective monitoring of well-field (well and reservoir) performance are as follows, with greater detail for some categories provided in Section 7.3. (Power plant performance is not considered herein.)

- Well completion data from drilling records
  - These include location, depth, sub-surface trajectory, casing and liner configuration, the wellhead configuration and any notable issues concerning the well.
- Flow rates
  - Production and injection flow rates as measured by continuous-reading sensors and point-in-time measurements using various types of mechanical and electronic gauges. These include measurements of two-phase rates and separated steam and liquid rates at various points in the system that leads to and from the power plant.
  - Metering of flow on continuous-reading sensors can be affected by scale deposition.
  - Two-phase measurements are less accurate than measurements of steam and water separately, so measurements at several points in a system are often used to estimate the flow at specific wells.
  - Point-in-time measurements (such as tracer-dilution tests) provide periodic checks on the accuracy of continuous measurements and help track changes in enthalpy (see below).
- Pressures and temperatures

- These are measured at various points: down-hole when practicable (as this provides the most accurate picture of the production horizon), at the wellhead, in observation wells (when available), at steam-water separators, on flow lines, at the plant inlet, and at the plant outlet.
  - Well logging entails running sensors down-hole on a wireline, which can be done with the well shut in or flowing.
  - Observation wells are wells drilled in the field that may not be suitable for production or injection (possibly due to low permeability or some mechanical problem), but may still be useful to monitor trends in reservoir pressure.
- Enthalpy
    - Enthalpy is the heat energy content per unit mass of well flow and it determines (with flow rate) how much electricity can be generated, or how much energy is available for direct use. In compressed liquid water, enthalpy is approximately (not exactly) proportional to temperature, but in a 2-phase flow of steam and water (as at the Puna resource) enthalpy increases with steam fraction because the enthalpy of steam is very much greater than the enthalpy of water at the same temperature.
    - For a 2-phase system enthalpy is calculated from the steam fraction (ratio of steam rate to total rate) and temperature or pressure.
    - Due to uncertainties in the rate measurements (larger at some projects than others due to factors that include system design and data collection practices), the enthalpy of a 2-phase flow at the time of measurement is often uncertain by 5% to even 10%.
    - Many projects have no method to continuously monitor enthalpy at each individual well, because the flows of several wells are combined before steam-water separation (where the steam and water rates can be accurately metered).
    - In such settings, the flow rates of steam and water and corresponding enthalpy of each individual well are measured about once per year using a separate test (commonly by using the tracer-dilution test method described in Chapter 6). Between these measurements, the individual well rates and enthalpies are initially assumed to be constant and may be later refined if the next measurement is different and other data (such as wellhead pressure) suggest when the change occurred.
    - For an (uncommon) dry-steam system enthalpy is determined (with relatively high precision) by the pressure and temperature of the produced steam
    - For a system producing single-phase water enthalpy is determined (with relatively high precision) by the temperature of the water.
  - Chemistry
    - Well flow chemistry is monitored for several reasons, including:
    - it determines the susceptibility to scaling and/or corrosion of down-hole equipment (for example, well casings and liners) and surface fluid-handling systems;

- the amount of non-condensable gas (NCG) in the steam affects the efficiency of the plant and the processes needed to avoid air pollution; and
- changes of reservoir chemistry can occur as a result of reservoir processes (boiling, cooling, mixing), help to understand the behavior of the system under exploitation, and help to predict upcoming changes in the reservoir (such as cooling).
- Down-hole pump data
  - Directly measured data from the pumps, including down-hole pressure, discharge pressure at the surface, power (Amps) and frequency (Hz).
- Reservoir pressures in observation wells
  - Down-hole pressure tools can be installed in an observation well to allow for the direct observation of hydrologic processes within a geothermal reservoir, providing detailed information that can be used to enhance the performance and sustainability of a power generation system.
  - It is important to keep the pressure-measuring system well-calibrated.
- Plans for additional drilling or changes in field-management strategy
  - Effective field management may entail drilling new wells during the life of the project and it could also involve converting production wells to injection wells, or vice versa.

Interpretation of these data and reservoir modeling are necessary for understanding the reservoir behavior. The data are also very valuable to the daily running of the power plant to meet production goals and to detect any abnormality in well operations that may require intervention.

Additional monitoring routines should be employed to check for problems that can be observed at the surface, including:

- changes in surface thermal features or the development of new feature locations;
- changes in wellhead height;
- leaks from the annular cement between casing strings at the surface, from outside the surface conductor casing, or from elsewhere at the wellhead (see treatment of mechanical failure in Chapter 8);
- evidence of internal corrosion in the wellhead that can be measuring using ultrasonic testing (see Section 7.2);
- evidence of scaling in the wellhead manifested by changes of pressure and flow rate and by an inability to fully open and/or close the wellhead control valves; and
- evaluation of the production casing down hole using caliper surveys (see treatment of mechanical failure in Chapter 8).

A record of visual inspections as well as regular photographs can also be of value in a monitoring program.

Other forms of special testing and analysis may be performed on a periodic basis, using the techniques described in Chapter 6 (Well Completions and Testing). These may include wireline surveys, pressure-transient tests, tracer-dilution tests, and inter-well (reservoir) tracer tests. The outcomes of such tests, along with routine measurements of flow rates, temperatures, and pressures, can be incorporated into a numerical simulation of the reservoir, to allow predicting field performance and evaluating alternate scenarios of production and injection.

## 7.2 Well and Surface Equipment Maintenance

Good maintenance practices are important for ensuring the safety and security of the well site and all personnel as well as for supplying steady power output. Maintenance practices for the wellbores, wellheads and surface pipelines and plant equipment are detailed below. Not all practices are applicable to all resources, and those presented here are focused on practices that are likely to be relevant in Hawaii.

### *Hawaiian Regulations*

As required by the State of Hawaii in the Hawaii Administrative Rules Title 13, Chapter 183, all wells and associated components and equipment (*e.g.* wellhead, pumps, valves, pipelines, etc.) shall be operated and maintained by the operator in good working condition in order to prevent unacceptable pollution, waste and the loss of or damage to life, health, property, natural resources, and environment. Specific items to note are:

- Wellheads and connected surface equipment must pass a pressure test of at least one and a half times the calculated or known pressure of the geothermal reservoir tapped by the well.
- Periodic corrosion surveillance of any surface equipment may be conducted by the BLNR chairperson or authorized representative, and any leakage, waste, or hazard shall be promptly corrected by the operator.
- Well operators must notify the BLNR of any blowout, break, leak, or spill of any well or portion of the pipeline system, in writing within ten days after discovery of the incident.
- The BLNR must notify the operator of any well not being operated or maintained in accordance with these rules to take whatever steps may be necessary to remedy the defect at the operator's expense within the period of time specified in the notice. If the operator fails to comply with the notice and remedy the defect within the specified period, the chairperson may do the work as may be necessary to plug and abandon the well or put it in proper condition at the expense of the operator or the surety and the chairperson may take necessary action to enforce the penalty provided in these rules.

### *Wells Down-hole*

The integrity of the casing down-hole should be monitored for any number of potential issues, including but not limited to: corrosion, leaks, collapsed sections, buckling or parting of joints and scaling. Because casing repairs and workovers are costly, minimization of potential damage can be achieved by:

- Adjusting flow velocities in production wells to minimize wear on liners
- Avoiding frequent shut-ins to minimize thermal expansion and contraction

- Installation of hang-down liners to protect permanent casing

Additional measures to prevent scaling should be taken, such as maintenance of adequate flowing wellhead pressures, use of scale inhibitors, and implementation of work-over programs to physically remove accumulations of scale.

The appropriate operating ranges for flow velocities and wellhead pressures depend upon the characteristics of particular wells, such as enthalpy and chemistry. For instance, down-hole injection of scale inhibitors through capillary tubing has been proven effective in controlling calcium carbonate scale in many fields, but effective application of the inhibitor may require a certain minimum wellhead pressure. Even with best efforts to control scaling, periodic work-overs with a drilling rig are likely to be needed during the life of the well.

#### *Wellheads and Surface Pipelines*

Well pads and all site locations should be maintained in good condition at all times, allowing access to all wellheads, surface pipelines and equipment. All metal components of the permanent wellhead stack and other surface installations should be maintained free of corrosion and rust.

The well identification name and/or number should be placed on the wellhead or immediately adjacent to the wellhead location and should be clearly visible. Cellars should be kept free of pooling water, and well pad infrastructure should be constructed in a manner that minimizes erosion and disturbance to natural drainage.

Various methods of maintenance of wellheads and pipelines which are in common practice include:

- Ultrasonic testing to monitor pipe thickness (with repeated regular readings taken at specific points on the wellhead and pipelines).
- Wells that are not in active service should be managed to prevent accumulation of dangerous and corrosive gas in the interior of the wellhead. This may require keeping the well on bleed (with appropriate abatement of H<sub>2</sub>S emissions), or blanketing the interior of the completely shut-in well with pressurized nitrogen.
- Twin flow lines between the wellhead and the main production line - particularly applicable for wells with large flow capacity. This allows maintenance on each line individually without having to shut in the well. It also balances the loads on the wellhead, since produced fluids are directed to pipes that leave the wellhead in opposite directions.
- “Rock catchers” at or near the wellhead to prevent rock fragments from entering pipelines and plant equipment further downstream. They catch the rock fragments that are normally produced along with the water and steam and are to be periodically emptied.
- pH control to minimize silica scaling - often applied downstream of steam/water separators. Small amounts of acid are added to surface pipelines at points which are prone to scaling to keep the injection pipelines and wells free from scale.

### *Plant Equipment*

Geothermal plants often comprise several modular turbine/generator (TG) units. Individual modules can be taken off line for routine maintenance without shutting down the entire plant. However, plant-wide shut-downs (also known as overhauls) are periodically necessary to conduct scheduled maintenance or install updated equipment. The frequency and duration of TG unit overhauls depend on the type of plant equipment as well as the characteristics of geothermal fluid. Many facilities will perform annual overhauls that last on the order of a week, with longer overhauls every 3 to 5 years.

## 7.3 Well Records and Reporting

### *Hawaiian Regulations*

In accordance with the regulations specified in the Hawaii Administrative Rules Title 13, Chapter 183, operators must keep accurate well records of each well, which include the following information:

- well lithology and depths of formations encountered (including losses of circulation, significant mineralization changes, tight hole, etc.)
- core records and logs
- water-bearing and geothermal heat-bearing strata, their depths, pressures and temperatures (including steam entries and changes in the rate of penetration)
- other well surveys and logs recording temperature, chemical, radioactive and electrical characteristics of the well

Additional reports detailing the field production or utilization of the resource and any by-products may also be required, and may include the following:

- drilling records detailing the real-time drilling parameters (*e.g.* hook load, pump stroke, rotary torque, standpipe pressure, rotary RPM and depth)
- well completion data including the depth and diameter of each wellbore segment
- depth, length, weight, grade and type of all joints of casing and all casing accessories (*e.g.* shoe, hanger, float and collar)
- cementing records including the type, additives, volume, depth, top and success of each cement job and/or plug conducted
- drilling bit records (including the manufacturer, type, run number, date in, date out, condition, *etc.*)
- details of any equipment or tools (“fish”) left down-hole
- directional survey and well course data
- specifications of the components used in the permanent wellhead equipment

HRS 183 also requires that "all physical and factual exploration results, logs, and surveys which may be conducted, well test data, and other data resulting from operations..." must be furnished to the BLNR (Patterson *et al.*, 1994b).

Some additional records that are required by the State of Hawaii are mentioned in the following section.

### *Types of Reports*

A number of reports and logs have been developed by the worldwide geothermal industry in support of drilling operations. Not all logs and reports are appropriate for each project. Operators should coordinate with BLNR staff in advance of drilling to ensure that appropriate drilling records are maintained for the project concerned. The basic records and logs that must be kept include the following:

- Daily Drilling Reports
  - The daily drilling reports kept by the drilling crew on the rig are the most valuable source of information on the actual drilling operations and accomplishments in each geothermal well (Figure 7.1). The most widely used form in both the geothermal and petroleum industry is the IADC API Official Daily Drilling Report Form. Frequent review of the accuracy and completeness of these reports should be made by the Operator's drill-site supervisor. For every geothermal well drilled, the Operator should preserve a complete set of daily drilling reports as the primary historical record of well construction.
- Well History Report
  - This report describes in detail all the significant operations that were carried out (Figure 7.2). The data are typically presented as a chronological description of the entire drilling operation, with daily entries from spud date to completion date. The well history report is essentially a compilation of the information from the daily drilling reports into a single document.
- Well Summary Report
  - This report is comprised of pertinent data on the condition of the well at the time of completion and should include details such as well location, casing depths, completion interval, completion date, and production test results, if available. This report is typically presented not as a single form, but as a detailed document.
- Monthly Operating Reports
  - This is a monthly report on the amount of geothermal fluid produced, injected, sold or used from any well which is in operation as a production or injection well or is producing geothermal by-products. Figure 7.3 shows the template of a widely used monthly operating report: the Monthly Report of Geothermal Operations as promulgated by the Bureau of Land Management (BLM) of the U.S. Department of the Interior.
- Additional Reports - Upon completion, suspension or abandonment of every geothermal well, the operator must provide (in accurate, complete and final form) the following well reports to DLNR within six months:



- All drilling logs, such as the mud log, which presents continuous profiles of all lithology, fluids, and temperatures encountered from the surface to total depth. Any electric logs and descriptions of any cores obtained should be included in this wellbore data package.
- A wellbore directional survey from surface to total depth, if the well has been drilled as a deviated hole, or re-drilled by deviated course from an original vertical hole.

All of the documents and reports cited above are important baseline information to both the Operator and to the DLNR. These comply with the basic requirements of the laws and regulations. They also provide a critical basis for evaluations of drilling operations and for future improvements in well design, construction, safety, reliability and cost control.

## 8. WORKOVERS, PLUGGING AND ABANDONMENT

### SUMMARY

- 8.1 Workovers: Common situations that require workovers.
  - 8.1.1 Typical Well Issues Requiring Workover Operations: Causes and conditions.
  - 8.1.2 Permitting for Workover Operations in Hawaii: Regulations and necessary documents.
- 8.2 Plugging and Abandonment (P&A): Requirements and recommendations.
  - 8.2.1 Permitting for Operations in Hawaii: Process and description.
  - 8.2.2 Procedures Required by Hawaiian Regulations: Specific regulations in Hawaii.

## 8.1 Workovers

Proper maintenance and operation of geothermal wells is vitally important in achieving success for a geothermal project. At some point during the operating lifetime of a geothermal production or injection well, the need for a workover may arise if there has been a substantial decline in production rate (more than expected from reservoir pressure decline), a reduction in injection rate or capacity, or if physical damage to the wellbore or its casing has been detected. Additionally it may be determined that the original wellbore needs to be deepened or a forked or multi-well completion may be necessary in order to sustain generating capacity.

### 8.1.1 Typical Well Issues Requiring Workover Operations

#### *Brine Chemistry*

Brine chemistry can cause two major well problems: corrosion and scaling.

Common geothermal systems almost always contain dissolved or free carbon dioxide (CO<sub>2</sub>) and hydrogen sulfide (H<sub>2</sub>S) gases. The alkalinity of the drilling fluid is important for corrosion control during drilling operations, but corrosion of the down-hole casing can occur during plant operations after prolonged exposure to production and injection fluids saturated with these gases.

KERZ geothermal wells that have tested at high-temperature fluid flows, and then are placed in a full shut-in status can build up highly concentrated H<sub>2</sub>S gas caps. Prior to placing a high-temperature well on shut-in status for extended lengths of time, the operator may pump a caustic water solution down the wellbore to abate any H<sub>2</sub>S and protect the well from acidic corrosion. This column of caustic water solution can then be pressurized (blanketed) with nitrogen to keep any remaining H<sub>2</sub>S gas in solution. This would prevent a highly concentrated H<sub>2</sub>S gas cap from forming while the well is on shut-in status.

Scaling, the buildup of mineral deposits both inside the casing and in the production interval, is a problem at geothermal plants around the world, and can lead to frequent workovers (Figure 8.1). Common scaling minerals include calcite, silica and silica-rich sulfide deposits, and in some settings alumino-silicates or hydrous iron silicates – the scaling type is specific to the chemistry of the well and can vary well to well within the same field.

The most-common production well scale is calcite (calcium carbonate), although it is rare if reservoir temperatures are quite high (and not an issue at Puna). Where calcite scaling occurs, mechanical clean-outs are used but, in addition, acid cleaning readily dissolves the scale. The acid is corrosive to the steel casing, therefore an inhibited acid solution (HCl) is used and the acid is often pumped down-hole through tubing directly into the plugged section. It is highly preferable to inhibit or prevent scale formation in the first place, rather than to remove it, and there are many chemical techniques available for this. A scale inhibitor acts by “coating” calcite crystals as they are formed, thus preventing them from adhering to one another and to the walls of the well.

In the Puna district, due to high temperatures and the reservoir rock composition, the scale that deposits is typically amorphous silica (SiO<sub>2</sub>). Casing scale can sometimes be removed with high-pressure jets, but scaling in the wellbore often seals the formation and must be drilled out with an under-reamer (an expandable bit that can drill a hole below casing that is larger than the inside diameter of the casing).

### *Mechanical Failure*

The more serious and costly well problems arise when there is a leak in the casing, or it is otherwise physically damaged in some way. Usually, the problem can be traced to corrosion damage, breaks caused by thermal expansion and contraction, wear from drill pipes, or bad welding or cementing of the casing.

The most common manifestation of a leak is that steam starts escaping from the exposed annulus between the casing strings or in the cellar. Steaming ground around or near the well is another indication. Damage can also go undetected and only shows up when a logging tool does not pass to the bottom of a hole, or when a drill bit is held up while reaming scale deposits. The leak can initially be small, but will grow as the erosive effect of steam and/or water increases. For this reason, it is necessary to act quickly while the problem can still be managed, usually by first injecting cold water to quench the well in order to safely conduct workover operations.

Once the well has been quenched, a variety of methods are available to determine the cause of the mechanical failure: a temperature log will reveal any leaks by showing a spike in in the log at the entry/exit point; a caliper log together with a CCL (Constant Collar Locator) will show any collapses, breaks or corroded sections in the casing; packers can be set down-hole to conduct pressure testing.

### *Generation Capacity Decline*

A variety of workover techniques are used to maintain the generation capacity of a given well field. These operations typically involve one or a combination of the following: cleaning of the production casing, deepening the production zone, sidetracking the well and under reaming the well.

#### 8.1.2 Permitting for Workover Operations in Hawaii

When it has been determined that a well needs a workover, Hawaiian regulations require that the lessee/operator must first file a Geothermal Drilling and Well Modification Permit Application and any associated fees with the State of Hawaii's Department of Land and Natural Resources (DLNR) – Engineering Division in order to obtain approval for any workover or modification operations. Additional documentation, such as the lessee/operator information, well designation, workover plan, workover summary, description of drilling and casing program, if any, and any necessary bonding requirements documentation shall be provided.

#### 8.2 Plugging and Abandonment (P&A)

When a well is no longer needed, because it is damaged beyond repair, the geothermal reservoir becomes depleted, or no resource was found (called a dry-hole), the well should be plugged and abandoned.

A well is typically plugged by placing cement in the wellbore or casing at certain intervals. The purpose of the cement is to seal the wellbore or casing and to prevent fluid from migrating between underground rock layers.

In Hawaii, all wells must be plugged and abandoned in accordance with the regulations specified in the Hawaii Administrative Rules Title 13, Chapter 183 in order to protect the ground-water resources of the State of Hawaii from contamination and waste, and as well as to protect public health and safety.

Cement plugs are required to be placed across the geothermal reservoir (zone plug), across the base-of-fresh-water (BFW plug), and at the surface (surface plug). Other cement plugs may be installed at the bottom of a string of open casing (shoe plug), on top of tools that may have become stuck down hole (junk plug), on top of cut casing (stub plug), or anywhere else where a cement plug may be needed to isolate the interior of the well from its surroundings. Also, the hole is filled with drilling mud during abandonment to help prevent the migration of fluids between zones.

Further details concerning the required procedure are discussed in section 8.2.2.

### 8.2.1 Permitting for Operations in Hawaii

If a well is determined to be no longer needed for production, injection, monitoring or observation, or if it is determined to be not mechanically sound, the State of Hawaii may order the lessee/operator to abandon the well. Wells may be permanently abandoned, temporarily abandoned, or suspended in accordance with the State of Hawaii P&A regulations.

The lessee/operator must first file Geothermal Drilling and Well Modification Permit Application and any associated fees with the State of Hawaii's Department of Land and Natural Resources (DLNR) – Engineering Division (DLNR 2014d; DLNR, 2014e).

The following supplemental information is also standard for issuance of a permit to P&A:

- A plot plan showing the tax map key, site elevation, and well location to establish property corners.
- A statement of the purpose and extent of the proposed work.
- A proposed Work Program detailing the operations to be performed, typically including:
  - the type, depth, length and interval of expected plug placement
  - methods to be used to verify the plug placement and success (tagging, pressure testing, etc.)
  - weight and viscosity of mud that will be used in the un-cemented sections
  - perforation or removal of any casing
  - type of surface equipment used and surface restoration procedures
  - a plan or schematic of the vertical section of the existing well showing the proposed work.
- A statement agreeing to file a bond. (Any bond covering the lease or an individual well must remain in full force and effect until the lease or individual well is properly abandoned and the surface restored.)
- Any other information requested by the State of Hawaii.

Upon approval, the State of Hawaii will notify the lessee/operator that operations may commence and if a state-appointed witness is required to be present for P&A activities.

A licensed well driller with a C-57 license is required to perform all well abandonment and sealing (DLNR, 2004). A detailed record of the abandonment and sealing of all wells must be maintained by the

well driller for future reference and demonstration that the well was properly sealed. A well abandonment report must be filed with the Commission on Water Resource Management within 60 days after completion of the work (DLNR, 2014f).

The following information should be attached to the Well History Report:

- A complete, chronologic report detailing daily abandonment activities.
- A description of each plug set, including:
  - Type and amount of cement used
  - Depth drill pipe or tubing was run to set the plug
  - Depth of top of plug
  - Method of verification of plug placement/success.
- A description of the surface restoration activities.

### 8.2.2 Procedures Required by Hawaiian Regulations

As noted in the introduction to this Chapter, during a plugging and abandonment operation cement plugs are placed down-hole in order to isolate formations penetrated by the well bore, to protect and isolate the fluids within those formations, and to prevent inter-zonal migration, either inside the casing or through the annulus.

Grouting materials acceptable for use to permanently seal wells and test borings are neat cement, sand-cement slurry, concrete, cement bentonite or bentonite pellets. The materials selected depend on field conditions and must be approved by the BLNR Chairperson prior to sealing. After grouting, all wells must be sounded to determine if the grout has settled (DLNR, 2004).

For abandonment of a full-diameter geothermal well used for either production or injection, State of Hawaii law states that the following regulations apply:

- Any interval not filled with cement must be filled with good-quality, viscous drilling fluids.
- Cement used for down-hole plugs must contain a high temperature admix in order to be able to withstand high temperatures and be set in place by pumping through drill pipe or tubing.
- 100 feet of cement must be placed straddling the shoes of all casing strings and at the bottom of the conductor pipe.
- Cement plugs must be placed across all uncased or perforated zones of the wellbore, and extend 100 feet above and below each zone. Exceptions as follows:
  - 100 feet of cement must be placed straddling all casing stubs and laps.
  - If unable to enter casing stubs or laps, 100 feet of cement must be placed immediately above the stub or lap.

- If casing is collapsed in uncased or perforated zone, extending 100 feet above the zone by squeezing.
- All open annular spaces extending to the surface must be plugged with cement, and a cement plug of 50 feet must be placed at the top of the hole.
- The location and hardness of cement plugs should be verified by setting down with tubing or drill pipe at a minimum of 15,000 lbs of applied force, or the maximum weight of the available tubing or pipe if less than 15,000 lbs. Retainers and bridge plugs would be exempt.
- All casing strings must be cut off at least 6 feet below ground level and capped by welding a steel plate on the casing stub. The well number and date of abandonment must be clearly marked (etched or welded in the metal) on the steel plate. All structures (cellars, pits, etc.) and other facilities must be removed.
- The surface location must be restored as near as practicable to original condition, and a Well History Report must be filed within 60 days of completion of abandonment operations.

## 9. EMERGING TECHNOLOGY

### SUMMARY

- 9.1 Drill Bits: Alternative types of drill bits and applications.
- 9.2 Drilling Tools and Techniques: Alternative down-hole motors and advancements in explosive drilling tools.
- 9.3 Rotary Steerable System (RSS): Improvements in directional drilling tools.
- 9.4 Casing While Drilling (CWD): Application and advantages of CWD.
- 9.5 Coiled-Tubing Drilling (CTD): Developments in CTD applications.
- 9.6 Mono-Diameter Wells: Developing technology for larger diameter completions.
- 9.7 High Temperature Cements: Design and application of foamed cement.
- 9.8 Aerated Mud: Recent successes in application of aerated muds in Hawaii.
- 9.9 Lost Circulation Material: Effective use of micronized cellulose for drilling fluid loss control.
- 9.10 Logging Tools: Developing technology for down-hole logging.
- 9.11 Fluid Sampling: Recent tool developments for down-hole fluid sampling.
- 9.12 Power Plant Technology: Advances in meeting peak power dispatch demands.
- 9.13 Trained Personnel and Detailed Procedures: Benefits of geothermal drilling experience and acting on lessons learned.
- 9.14 Other Advanced Techniques Under Development: Recent industry developments.



Technological advances are critical to geothermal development in Hawaii because of the many regulations already in place (*e.g.* no-venting to atmosphere, night-time ban on drilling, etc.). Additionally, the very nature of the geothermal environment found in Hawaii is harsh on equipment and tools. Advancements that work towards overcoming environments that are naturally very high in temperature and corrosive gasses will be invaluable to development. Technological improvements can only help make drilling safer and more economical while bringing down project costs by reducing drilling time and increasing success rates.

Examples of successful solutions already utilized in Hawaii include:

- The use of a casing patch to repair parted casing without having to pull and replace production liner and with minimal restriction of production (PGV well KS-10RD);
- The use of foamed cement for installing long strings of casing, avoiding the need for two stage jobs or tie-back strings that may not hold up to thermal stresses;
- The implementation of a well-planned reverse circulation cement job to avoid incidents that may arise from such a complex process;
- Utilization of micronized cellulose LCM to prevent mud and cuttings from permanently plugging moderate permeability zones;
- Successfully drilling with aerated mud in areas known for lost-circulation, hole-cleaning, cooling and stuck pipe issues;
- Procedures dealing with sticking pipe and lost circulation helped to prevent small problems from becoming larger ones.

These solutions have been developed in spite of the fact that geothermal drilling mostly relies on derivations from technology used in oil and gas because the geothermal drilling market is small by comparison and the funding for new R&D and technological advances in oil and gas drilling is far greater. Looking forward to further geothermal advancement, it is useful to look at drilling methods and technologies from the oil and gas market that are promising, particularly for drilling in high-temperature environments.

High-temperature (HT) drilling components that are undergoing development and demonstration include:

- Drill bits with HT sealed bearings.
- HT directional tools – “steerable” drilling assemblies.
- HT drilling fluids and cements.
- HT logging cables and tools.

## 9.1 Drill Bits

### *PDC Bits*

Polycrystalline diamond compact (PDC) bits are routinely used in the oil and gas industry for drilling in medium-hard rock but have not been adopted for geothermal drilling, largely due to past reliability issues and higher costs.

The Polycrystalline Diamond Compact (PDC) bits were originally designed as an alternative to the roller cone bit to increase ROP, wear resistance and overall bit life. The geometry of the PDC cutter changed the cutting mechanics from a point load, or crushing of the rock, to a transverse shearing motion. PDC bits have a number of advantages over roller cone bits in some environments, however in geothermal PDC bits have had limited application. A new, hard, thick, shaped Stinger™ PDC has been developed that aims to combine the crushing and shearing action to improve ROP and overall cutter life (Durrand *et al.*, 2010).

Laboratory testing results of the Stinger cutter on a Vertical Turret Lathe (VTL) include:

- Reduced vertical and drag forces compared to conventional shear cutters;
- Significant improvement in abrasion resistance during extended wet testing;
- Higher linear footage before burn out in dry/hot testing compared to conventional PDC.

Laboratory testing at Terra Tek showed the Stinger bit successfully cut hard abrasive rocks with no observable wear. All this suggests that Stinger PDCs may represent a significant step toward the goal of long-life bits for hard formations in hot environments. Additional testing was noted to still be needed for geothermal applications (Durrand *et al.*, 2010).

Sandia Geothermal Research Department recently completed a field demonstration of the applicability of advanced synthetic diamond drill bits in a geothermal drilling environment (Raymond *et al.*, 2012).

Two commercially-available PDC bits were tested at the Chocolate Mountains in Southern California. These bits drilled in granitic formations with significantly better ROP and bit life than the current roller cone bits in use.

Table 9.1 shows the computed and summarized drilling costs (based on the rate of a single rig and a round-trip tripping rate of 1000 feet/hour) for all of the bits run in the field comparison demonstration, validating that commercial-off-the-shelf PDC bits are capable of drilling geothermal wellbores at ROPs well above those experienced with roller cone bits and that these PDC bits have demonstrated longer lifetimes than roller cones in this geothermal drilling environment (Raymond *et al.*, 2012).

#### *High-Temperature Roller Cone Bits*

The Kaldera high-temperature (HT) roller cone bit represents a new line of roller cone bits specially designed to endure high-temperature drilling environments like geothermal wells for extended periods (Figure 9.1). For example, at The Geysers steam field in California, the geothermal reservoir can reach temperatures in excess of 600°F. Wells are typically drilled using air at The Geysers to cool the bearings of open roller bearing bits instead of the standard drilling mud. The 8-1/2-inch roller cone bits being used had an average drilling life of 30 to 35 hours before being tripped out to avoid bearing failure and loss of cones (Schlumberger, 2013).

The Northern California Power Agency (NCPA), operating in the southern portion of The Geysers, worked with Smith Bits to employ a more durable bit that would reduce trips and improve drilling performance. NCPA utilized the 8-1/2-inch Kaldera High-Temperature (HT) roller cone bit which has advanced bearing system materials that enable it to endure the extreme heat that would normally cause

standard bearing lubricants to break down and compromise seals. This break down quickly erodes bearing functionality, leading to premature loss of roller cone performance and shortening bit life. The Kaldera bit's HT design utilizes:

- Finite element analysis (FEA) optimized seal geometry and gland design;
- Robust grease reservoir system;
- High-load capacity bearing design and materials;
- Computer numerically controlled (CNC) precision manufacturing tolerances.

The Kaldera bit used by NCPA drilled for 49 hours from a depth in of 7,233 feet to 8,005 feet, enduring bottom-hole temperatures that ranged from 500° to 600°F. When compared with bits used to drill offset wells, the Kaldera bit drilled 14 hours longer and approximately 150 feet farther, representing a run length increase of 25% (Figure 9.2) (Schlumberger, 2013).

At the Larderello steam field in Tuscany, Italy, ENEL Italy field tested three Kaldera roller cone bits in the hard and abrasive granite/metamorphic reservoir, where average temperatures are 320°F to 350°F with spikes up to 570°F. The new seal and grease formula had a positive impact on run length and increased on-bottom drilling hours by 37% when compared to an offset well drilled with a standard roller cone (Figure 9.3) (Schlumberger, 2011). The last Kaldera run at Larderello set a new field record by logging 76.5 on-bottom drilling hours while compiling high total bit revolutions (300,000 revs). All three bits came out of the hole in good dull condition with eight of the nine seals still effective.

#### *Hybrid Drill Bits*

Baker Hughes has developed the Kymera Hybrid drill bit, which combines roller cones and PDC fixed cutters in a single bit (Figure 9.4). Field test results from a geothermal project for the Iceland Drilling Company reported that the rate of penetration (ROP) was twice as fast as their premium roller-cone bit, with the average ROP at 10.8 meters per hour (Baker Hughes, 2011). Control of the down-hole vibrations, which result in cutter breakage, was maintained by reducing the weight on bit (WOB) and using a steerable motor.

#### *High-Temperature Elastomer Seals*

For penetrating hard crystalline formations, tungsten carbide insert (TCI) roller cone bits have historically been in use. Standard geothermal bits and components, including grease and elastomer seals, are commonly adequate for temperatures up to 302°F (150°C) (Orazzini *et al.*, 2011). Above these temperatures, the internal components of the bit and lubricating material can degrade causing bearing failure and thus limiting on-bottom drilling hours. New roller cone (RC) bit technology has been proven to effectively increase the on-bottom hours (by 3%-37%), and reduce the number of bit trips and bit consumption (by 33%-36%) in a field demonstration conducted in the high-temperature steam field at Larderello, Italy.

Temperature resistant elastomers and grease compounds were first developed and tested in a controlled laboratory environment. The experiments resulted in a new line of roller cone bits equipped with an innovative bearing system that utilizes proprietary composite elastomer seals with Kevlar® fabric and a proprietary high-temperature grease formula (Figure 9.5). These innovations increased seal life, lubricity

and load capacity at elevated temperatures for high-temperature/high-pressure (HT/HP) applications (Orazzini *et al.*, 2011).

## 9.2 Drilling Tools and Techniques

### *BHA Motors*

Schlumberger's Neyrfor high-performance turbodrills feature a fully concentric drive-train rotation and are capable of delivering more down-hole mechanical drilling power than other drive systems under equal hydraulic conditions. By rotating the drive shaft at a higher RPM while remaining dynamically stable, Neyrfor turbodrills increase rates of penetration without the negative effects of excess torque (Schlumberger, 2014b). When compared with positive displacement motors (PDMs), Neyrfor turbodrills offer a number of advantages:

- Higher power and efficiency;
- Greater reliability and durability under HPHT conditions;
- Less vibration;
- More reliable directional and underbalanced drilling capabilities;
- Improved borehole quality.

Neyrfor turbodrills are currently rated to 500°F.

### *Explosive Tools*

Los Alamos National Laboratory has developed a number of explosively-actuated tools, for the functions described below (Finger and Blankenship, 2010). While none of these tools have been commercialized to date, the primary accomplishment of these developments was the consistent safe use of thermally stable explosives with high-temperature detonators.

- Back-off shots—used for unscrewing the drill string at a designated depth, when tools below that point were stuck.
- Acoustic-source detonator—could sequentially fire up to 12 detonators, generating signals for geophone calibration in adjacent wells.
- Drill-pipe or casing cut-off tool—used a shaped charge to cleanly sever tubulars at designated depth.
- Explosive fracture-initiation tool—used a shaped charge to initiate fractures in a specified open-hole interval (initial fracture is extended by hydraulic pressure).
- Explosive side-tracking tool—created a ledge in the borehole wall to provide a kick-off point for directional drilling.
- Explosive stimulation – high temperature explosive for stimulating a geothermal well.

### *Well Course Maintenance (Measurement While Drilling)*

During multiple-well operations at Puna geothermal field in 2005, rotation with drilling motors was observed to improve the rate of penetration (ROP) and use of measurement-while-drilling equipment (MWD) reduced the dog leg severity. The MWD provides better control with less severe dog legs and saves time running single-shots. Additionally, the Baker Hughes motors and MWD held up well to the stress of drilling large diameter hole and high temperatures (Spielman *et al.*, 2006).

#### 9.3 Rotary Steerable System (RSS)

Several geothermal wells were recently drilled in the Southern German Molasse Basin to depths of up to ~15,000 feet with a horizontal displacement in some of up to 9,800 feet, with drilling operations becoming increasingly challenging and cost-intensive (Lentsch *et al.*, 2012). Initially, conventional steerable motor systems were used to drill directionally, but the drilling performance was not sufficient, with penetration rates while sliding being 50-60% less than those obtained when rotating (Figure 9.6). Poor weight transition, motor stall outs, high bit wear and low penetration rates became progressively worse with depth. In addition, weak drilling performance could have been a major factor for causing over gauge hole, stuck pipe and inadequate cementation.

In order to avoid these problems, rotary steerable systems (RSS) were deployed in two subsequent wells. The result was a step change in well delivery time and a reduction in drilling cost, with no borehole stability problems encountered.

Current commercial offerings for directional drilling tools are rated for ~375°F (175°C) service while demands of the higher temperature drilling environment require operation for significant periods at temperatures up to 572°F (300°C). A US DOE Geothermal Technologies Program (GTP) project was initiated to develop a 572°F - (300°C)-capable directional drilling system consisting of a drill bit, directional motor and fluid in order to reduce well installation costs and improve economics of conventional and enhanced geothermal wells (Dick *et al.*, 2012). Research and development performed thus far in the project has identified a system concept that meets program requirements. Design and manufacturing is ongoing to produce field prototypes to be run in geothermal wells in 2013.

#### 9.4 Casing While Drilling

Casing while drilling (CWD) technology uses casing as the drill-string components, so the well is drilled and cased simultaneously (Figure 9.7). The casing must always be rotated by a top drive unit, and can be connected to the top drive by either screwing into the top coupling of the casing or by a fixture that stabs into the top joint of casing, locking and sealing to its inside diameter. The top drive circulates drilling fluid through the casing and back up the annulus, just as it would in a conventionally drilled well. The casing used during the casing drilling process is generally the same as would normally be used in a conventionally drilled well.

One of the main differences between drilling with a conventional drill-string and CWD is that drill collars are not used to provide weight-on-bit for casing drilling (although the connections for the casing strings may be different) (Teodoriu and Cheuffa, 2011). Generally, eight-round connections are replaced with buttress connections that include a torque ring for additional torque capacity, though other connections such as premium integral or coupled connections may be used as well. Newly developed connections help reducing the risk of failure, but can be more costly.

There are two basic ways that the bit can be attached to the casing:

- It can be semi-permanently mounted, so that it can either be dropped off the end of the casing at final depth, or can be drilled through for passage of a subsequent casing string; or
- It can be mounted on a drilling assembly that is retrieved either by wireline or drill pipe when the bit needs to be changed, or when the hole is at design depth (Finger and Blankenship, 2010).

If a retrievable bit is used, it must be small enough to pass through the casing's inside diameter, therefore an under-reamer must be used to cut a diameter that is large enough to pass the outside diameter of the casing couplings and to provide an annulus for the drilling fluid return flow.

The drilling rigs used for the casing drilling process can be either specially designed to apply this technology or be modified from conventional rigs (Teodoriu and Cheuffa, 2011).

As a variation of casing drilling, liner drilling technology and rotating casing while running has gained industry acceptance in recent years, which is proved by the large number of casing drilling applications reported.

As in conventional use, the top drive also has the ability to circulate continuously, which can be important in geothermal drilling with heat-sensitive down-hole tools.

There are several advantages to this technology, in that it can:

- Eliminate costs, time, and problems related to tripping drill pipe:
  - Time to trip drill pipe and handle the BHA is a significant fraction of total time (and cost) on some wells, and it is also the case that many problems of well control and hole stability are associated with trips.
- Reduce lost circulation problems:
  - CWD systems can continue drilling when lost circulation is encountered. The rock cuttings tend to be washed into the fractures or permeable zones, acting effectively as lost circulation material. The relatively narrow annulus also means that fluid flow rates can be lower than would be used with conventional drilling in the same size hole.
- Gain casing setting depth:
  - The ability to drill through lost circulation zones, or other weak formations, means that sometimes the casing can reach a greater depth than would be the case with conventional drilling. It is possible, for some well designs and lithologies, that the casing program could be re-designed to eliminate one string of casing, a major cost saving measure.
- Improve safety:
  - Handling drill pipe has one of the highest accident incidences in drilling; eliminating this activity means that the crew is exposed to less risk.

Although this technology has been used on hundreds of oil and gas wells, it has only seen limited use in geothermal, including use in New Zealand to successfully drill through an unstable formation (Finger and Blankenship, 2010).

Potential issues with CWD needing further research and development include:

- Retrievable drilling assemblies because they contain some elastomer components which may not hold up in the higher temperature environments.
- Hard-rock environments:
  - The cutting structure for most CWD bits uses PDC cutters and, as discussed above, use of these cutters in geothermal formations is not yet common. Recent experience in New Zealand and some field experience with hard rock in oil and gas drilling, however, indicate that reasonable performance with roller-cone bits and PDC under-reamers is available (Finger and Blankenship, 2010).
- Normal API casing connections cannot be used:
  - The connections currently in use in conventional casing programs are not capable of transmitting torque. Higher cost premium connections are required.

Although a number of questions remain to be answered, this CWD technology appears to have enough potential to warrant further investigation devoted specifically to geothermal drilling.

## 9.5 Coiled-Tubing Drilling

Coiled-tubing drilling (CTD) has been used for several years because it provides way to significantly improve economics when used in the proper application. Instead of using drill pipe, the technology uses a conventional drilling assembly with a down-hole motor mounted at the end of a continuous length of flexible tubing from a large coil parked over the well.

One difference is that coiled-tubing drilling uses higher bit speeds at lower weight on bit due to the structural differences in coiled tubing compared to jointed pipe (Teodoriu and Cheuffa, 2011). Coiled tubing makes the drilling process faster and safer by being continuous, however it historically has two major limitations, friction and high cost.

Recent developments include dedicated drilling rigs (hybrid drilling rigs) to accommodate the coiled-tubing unit. The use of coiled-tubing drilling improves safety, lowers the footprint impact and enables underbalanced conditions, (which can increase the ROP and potentially help drill through problem zones).

The main disadvantages are depth limitation, the coiled-tubing size restriction and mechanical issues associated, largely buckling and fatigue (Teodoriu and Cheuffa, 2011).

A recently notable development by Reel Revolution with the aim of reducing friction and cost, is the “revolver rig”, an API certified coiled-tubing drilling rig (Figure 9.8). It is capable of being rigged up and ready for drilling within 6 hours, can rotate coiled tubing from surface at up to 20 RPM and can back ream continuously while backing out of the well (Teodoriu and Cheuffa, 2011). Currently, the revolver

rig is outfitted with a 3-1/4-inch coil size, allowing the support of a 4-3/4-inch BHA and is capable of drilling a maximum size of 6-inches (PRweb, 2014).

## 9.6 Mono-Diameter Wells

In the geothermal project in the Molasse Basin of Southern Germany, cost savings of up to 15%, were achieved by applying the monobore casing construction approach (Oppelt and Lehr, 2012). The usability of the mono-diameter well design is dependent upon certain geological conditions, for example, overpressure regimes, in which the reservoir pressures are higher than hydrostatic pressure, limit the application of this alternative casing concept. In addition to direct cost savings, the mono-diameter design delivers a larger final diameter and enables starting with a smaller surface casing than the standard telescopic well.

A mono-diameter well design entails the reaming of a hole section below the first casing to create a larger diameter wellbore, running a tubular casing in place of this enlarged section of hole, and expanding the tube into place (Figure 9.9). This technology is still under development, focusing particularly on the following Issues:

- Providing a secure connection between the first upper casing and the lower set of expanded new casing. Ongoing research is being conducted.
- Connecting several individual sections of casing on the surface before being run into the hole (normally done through threaded connections) has presented some lifetime and reliability issues. Available expandable threads used for liner expansion applications have been unable to deliver sufficient sealing over time, and are too expensive to gain the 15% related cost savings. A new casing welding technology is the subject of continuing research.
- The monobore design requires an innovative drilling concept based on automated, directional pilot hole drilling, controlled calibration, and reaming. The pilot hole drilling tool includes an appropriate rock-destruction method for formations under a high compression state and a reaming tool that runs behind the pilot tool has already been evaluated, developed and used in various formations (Figure 9.10). The formation must be drilled and reamed so that the energy to remove the appropriate volume to final monobore diameter is minimal, while maintaining the stability of unprotected sections of the wellbore.

The monobore construction has been shown to provide a significant reduction in material costs: reduced expenditure for cost-intensive casing materials, minimized quantity of drilling fluids used and the use of a smaller drilling rig.

## 9.7 High Temperature Cements

### *Foamed CaP Cement*

At the Salton Sea geothermal field in Southern California, an operating company successfully cemented a geothermal well using foamed calcium aluminate phosphate (CaP) cement (mentioned earlier in Section 4.3.2) to achieve long-term zonal isolation (Berard *et al.*, 2010). The well was drilled in a highly corrosive carbon dioxide (CO<sub>2</sub>) environment and weak formations along the wellbore required careful planning and selection of the drilling fluid and cement properties to minimize lost-circulation potential



during the drilling and cementing of the well. When CO<sub>2</sub> comes into contact with Portland cement (a standard cement used in geothermal well completions), it reacts with its components deteriorating the cement matrix. This reaction, known as carbonation, can cause serious damage to well tubulars over time and destroy zonal isolation integrity, resulting in costly remedial services or even abandonment of a well (Berard *et al.*, 2010).

CaP is a specially formulated non-Portland cement that is both CO<sub>2</sub> and acid resistant. CaP cement is essentially a ceramic that is much less susceptible to attack by CO<sub>2</sub> and acid. CaP cement is resistant to CO<sub>2</sub> even at lower pH, thus an increase in permeability due to foaming would not compromise the mechanical/chemical integrity of the cement sheath. Calcium aluminate phosphate cement is a blend of high-alumina cement, sodium phosphate, and class F fly ash—which is pozzolanic in nature, and contains less than 10% lime (CaO).

The operation in the Imperial Valley consisted of performing an inner-string cementing foam cement job in a 20-inch casing string inside a 26-inch wellbore drilled to 1,407 feet. The main objective was to bring cement back to surface and provide long-term zonal isolation throughout the entire wellbore. The inner-string cementing method provided the following advantages:

- A large-diameter cementing plugs was not required;
- Cement contamination resulting from channeling inside the casing was reduced by pumping through the smaller inner string;
- Cement was discharged outside the casing much faster after mixing, reducing the risk of the cement slurry within the casing having a highly-accelerated setting time;
- The amount of cement that has to be drilled out of the large-diameter casing was reduced;
- Less circulating time was required with inner-string cementing.

## 9.8 Aerated Mud

Geothermal drilling in volcanic regimes often occurs in a highly fractured, hard, hot formation, posing drilling challenges that include: lost circulation, and hole-cleaning, cooling and stuck pipe issues. Although aerated mud is the preferred drilling fluid for operations performed in areas prone to lost circulation, drawbacks to running aerated fluids include:

- Inability of MWD function in aerated fluid;
- Decreased ability to lift cuttings due to reduced fluid density;
- Adverse effects on the ability to power positive displacement mud motors;
- Reduction of cooling effect on the wellbore due to the lowered thermal capacity of aerated mud;
- Faster erosion of drilling equipment exposed to high velocities;
- Problems with wellbore stability due to the reduced hydrostatic head.

During the drilling of PGV well KS-14 in 2010, the drilling operator was able to complete the 26-inch section of the well using aerated fluids without incident (Rickard *et al.*, 2011a). Additional solutions

implemented as part of the drilling program in order to address the historic Puna field issues of stuck pipe, lost circulation and irregular wellbore topography include:

- Use of a special stabilizer designed for maximum surface area to increase reaming performance.
- Use of a motor (not common in upper hole section drilling in this field) to utilize hydraulic energy when the short drill string did not allow for high collar weight to be exerted on the bit.
- Use of aerated mud in the shallow section of the well due to a lack of water supply. Foaming of the mud was initially achieved with mud detergent, and subsequently improved with the addition of a number of foaming agent (Table 9.2).

Rickard *et al.* (2011a) details the results and observations achieved by utilizing aerated fluid as follows:

- Decreased number of drilling days:
  - By utilizing aerated fluid the well was drilled in fewer days than nearby well KS-5.
- Utilization of a down hole motor:
  - As a performance drilling application, the additional RPM and down-hole torque of the motor provided the energy needed to efficiently drill the upper shallow portion of the well bore where the drill string is not yet long enough to have effective drill collar weight. The average WOB was below 10,000 lbs and the maximum WOB no more than 22,000 lbs. The stabilized motor also allowed better vertical control, resulting in a better wellbore profile.
- Setting casing:
  - The well was reamed and the casing reached the targeted depth without problems in approximately 13.5 hours.
- Use of aerated fluid:
  - When compared to offset wells drilled the ROP was above average. Less than 300 gpm was pumped with some returns to surface compared to 875 gpm and no returns without air in the other wells.
- Quality Chemicals:
  - A critical component to the success of the drilling program was the use of good quality foaming agents (which also reduced the number of products needed). The quality of the foam will determine what size cuttings can be carried (high quality foam should be able to carry cuttings immediately after being drilled), reducing the wear on the bit as it continues to drill on the material until it is small enough to be carried out. (Note: The drilling detergent used worked well as a supplement until reaching the water table. It is not recommended that it be used as an alternative to foamer. An immediate difference was observed at surface once the switch was made to Amber foam - returns were reestablished and the drill string rotating torque was reduced by better hole cleaning.)
- Hole Cleaning Capacity:

- After some experimentation, an optimum mixture was arrived at which worked adequately for hole cleaning. This information should be of use on future wells but would need adjustments based on specific well requirements and the amount of water influx encountered.
- Third Air Compressor:
  - In a regular stiff foam operation, two 1256 cfm air compressors would be ample. Due to the use of aerated fluid, it was thought a third compressor would be beneficial. The use of the mud motor changed the volume requirements dramatically. A third air compressor allowed for an increase to both air and pump volume, thus improving the efficiency of the mud motor. More air volume improved hole cleaning capabilities and can result in less chemical usage as well.

### 9.9 Lost Circulation Material

Lost circulation is one of the most troublesome and costly problems and can result in stuck pipe and cementing complications. Experience has shown that lost circulation is one of the top contributors to non-productive rig time. Most geothermal drilling operations use un-weighted low solids drilling fluids, while maintaining low mud weight, reducing circulation rates to minimize losses of circulation and improving the particle distribution for bridging pore throats and/or fracture (Rickard *et al.*, 2011b). Maintenance of a concentration of bridging material imposes limits on the screen size of solids control equipment, and any attempt to reduce screen mesh size (thereby increasing the openings) reduces the ability to remove drilled solids.

The use of fibrous micronized cellulose bridging material enhances the drilling fluids capabilities for sealing potential loss zones and the particle size is such that an effective concentration can be maintained throughout the mud system (with the added benefit of immediate LCZ treatment as it can be maintained in the mud at all times). A comparison of the particle distribution size of common geothermal fluid and fluid treated with micronized cellulose can be seen in Figure 9.11. Table 9.3 shows the fluid formulation for deep, high-temperature wells which require the use of a high-temperature de-flocculant (known as SSMA) for thermal stability, and synthetic polymers for filtration control (Rickard *et al.*, 2011b).

The micronized cellulose is a water-insoluble, sized, complexed cellulosic material used for controlling seepage and loss of circulation while drilling through depleted or under-pressured zones. It comes in three particle range classifications that are equivalent to (fine), (standard), and coarse. Figure 9.12 is a photograph comparison of the standard and coarse samples of the micronized cellulose.

### 9.10 Logging Tools

#### *Optical Fiber*

Although not a logging tool per se, optical fiber provides a cheap and reliable way to obtain a wellbore temperature profile. The conventional method of getting a temperature profile is to deploy a logging tool into the well that records temperature versus time, or using a tool on a cable that allows recording temperature data at the surface. This requires a winch to handle the wireline or slickline, and either method interferes with other drilling operations.

A relatively new method of temperature measurement is the use of optical (glass) fibers illuminated by pulses of laser light (Figure 9.13). As the laser pulse travels down the fiber, it undergoes both Rayleigh and Raman scattering. The Raman scattering is divided into two components, one with a shorter wavelength than the original pulse, and one with a longer wavelength (Finger and Blankenship, 2010). The ratio of these two components is a function of temperature and when combined with the time-of-flight for the pulse indicates the temperature of the fiber at a known distance from the emitting laser.

A fiber suspended in a well or emplaced outside of the casing will provide a continuous and immediate temperature profile of the hole. Optical fibers can successfully withstand high temperatures for short periods of time, however deployment of fiber optics for long periods of time (on the order of several years) is still being developed.

The principal source of attenuation or degradation in the signal is free hydrogen, which tends to combine with oxygen in the glass. Sandia National Laboratory has a patent on an improved doping material to reduce the hydrogen problem (Finger and Blankenship, 2010).

To date, the geothermal market has so far been unable to justify development of a new fiber process that could be used in high-temperature wells.

#### *Gamma Logs*

A standard natural gamma logging tool counts the combined emissions from all the varied constituents of the wellbore wall and presents the results as total counts. However, the energy displayed by each gamma strike on the detector can also be used to discriminate which element has produced it. Known as a “spectral-gamma” tool, it apportions the counts into various “windows”, each of which is indicative of a specific radioactive material and thus can, at any given point in the wellbore, determine the dominant radioactive material present.

Sandia Laboratories designed and built a down-hole spectral-gamma tool for geothermal logging (Finger and Blankenship, 2010). It was rated to withstand 69 MPa pressure at 660°F (~350°C). The tool was successfully used to log portions of the S8-15 corehole in The Geysers. Although high-temperature gamma ray tools exist in the oil and gas industry, there is no other high-temperature spectral-gamma logging tool known to exist to date (Finger and Blankenship, 2010).

#### *Borehole Televiwers*

Sandia National Laboratories developed a prototype televiewer in 1983 by taking a commercially available instrument and upgrading it with (military-specification) high-temperature electronics, seals, and materials so that it would operate, protected by a thermal flask, or Dewar, at 525°F (~275°C) for significant periods (Finger and Blankenship, 2010). In 1985 Sandia, in partnership with two geothermal operators, attempted development of a commercial logging tool based on this prototype, but the televiewer manufacturer changed direction and all the televiewer components and design information reverted to Sandia. Sandia completed the proposed design modifications in-house and the tool was successfully field tested in several hot wells.

Two copies of this tool were built—a geothermal operator lost one in the hole in Indonesia, and the other is on loan to the US Geological Survey. There is no domestic commercial high-temperature version of this instrument known, although a modified version is available from a European company (Finger and

Blankenship, 2010). A slim-hole version of the televiewer sized to run in 4-inch core holes is commercially available, but is not rated for high temperatures.

In 2003, Sandia supported a collaborative effort to develop a new-generation televiewer to be used at the US Navy's Coso geothermal field in California. This Dewared tool operated at high temperatures (525°F [ $\sim 275^{\circ}\text{C}$ ] for ten hours) and high pressure (83 or 138 MPa, depending on model). A televiewer with advertised rating of  $\sim 575^{\circ}\text{F}$  ( $300^{\circ}\text{C}$ ) for 14 hours is currently available (Finger and Blankenship, 2010).

### *High Temperature Components*

Temperatures encountered in many deep geothermal wells can reach several hundred degrees ( $>300^{\circ}\text{F}$  [ $\sim 150^{\circ}\text{C}$ ]) and more. Conventional semiconductor chips designed for hot environments begin to hit their thermal limits at around  $\sim 390^{\circ}\text{F}$  ( $200^{\circ}\text{C}$ ), but before that they begin to experience performance degradation resulting in poor quality data collection.

A new type of microchip developed at the Fraunhofer Institute for Microelectronic Circuits and Systems (IMS) can withstand temperatures in excess of  $\sim 575^{\circ}\text{F}$  ( $300^{\circ}\text{C}$ ) without loss of performance (Whitwam, 2014). Engineers used a silicon-on-insulator (SOI) Complementary Metal-Oxide Semiconductor (CMOS) design to allow circuits stand up to higher temperatures. The SOI design is intended to combat an effect of heat known as current leakage, by insulating each transistor from its neighbor with an additional non-conductive layer, thus preventing electrical currents from flowing outside the intended path (current leakage). Uncontrolled, current leakage causes errors and poor performance long before the chip itself melts. In addition to the insulation protecting transistors, IMS opted to use tungsten in the chips rather than aluminum to reduce long-term damage from heat. IMS has reported positive results from early tests and plans to begin offering this new service in late 2014.

### 9.11 Fluid Sampling

Obtaining samples of formation fluids (steam and/or liquid) at a specific depth is important for development of a geochemical reservoir model to identify the potential for production of non-condensable gases and other corrosive fluid components. Fluid samples taken at the wellhead give an average composition of fluids produced, but acquisition of samples from a specific depth interval is difficult.

In the early 1990s, Sandia National Laboratories led a team that developed a conceptual design of a new sampler that could operate at high temperatures and had an on-board computer to control operation of the sampler's valves (and could be programmed to open/close based on a number of different triggers, including time, temperature, time-rate-of-change in temperature, etc.). The prototype tool had a diameter of 2-inch and a length of 5.9 feet, making it is easily transportable and easily applicable for use slim hole wells (Finger and Blankenship, 2010).

As the tool is lowered into the well, the on-board memory also creates a temperature log to specify conditions at the sample point. Finally, the sampler is battery-powered, so that it can be run with simple slickline logging equipment. The prototype was tested in production wells at The Geysers in California (a high-temperature steam field), and showed good repeatability. The device was later commercialized with higher-pressure valves by Thermochem, Inc., and improvements to the tool continued (Finger and Blankenship, 2010). This tool's capabilities, which are believed to be unique, are especially valuable in vapor-dominated fields such as The Geysers and several in Indonesia.

## 9.12 Power Plant Technology

### *Dispatchability*

The geothermal industry has been struggling with certain barriers to development for a number of years: while geothermal is a reliable, steady base-load form of renewable energy, its development expenses overshadow its obvious long-term benefits. In order to promote the development of geothermal, innovative ways to make geothermal a smart, valuable investment for customers need to be demonstrated. Geothermal power plants can be designed with the capability to “dispatch,” or change the level of power output by ramping up or down depending on system needs, to the main power grid. While both geothermal power and natural gas are rampable, there are key differences (GEA, 2013). Geothermal energy dispatchability is particularly efficient due to:

- The amortized cost of the fuel source;
- Predictable and low long-term economics;
- Near-zero emissions.

Comparatively, ramping up production from either nuclear or coal power plants results in lower efficiencies and cost and emissions increases.

Ormat’s recent 8-MW expansion at Puna was designed to be fully dispatchable, meaning that it is controlled by the power supplier HELCO, who can ramp service up or down according to the load demands, making it more competitive with other renewables, such as solar and wind (Chicon, 2013).

## 9.13 Trained Personnel and Detailed Procedures

### *Stuck Pipe in Hawaii*

Stuck drill pipe is common issue in geothermal drilling that causes lost time, increased costs and can lead to damage of the wellbore. Many causes are known, though some are common to drilling in Hawaii: loose rocks can fall in around the drill pipe and sloughing hyaloclastite zones can lead to packing of fill around the drill pipe; new loss zones can pull cuttings back in from shallower loss zones and pack in around the drill pipe. At Puna, procedures were developed for the 2005 drilling program (during which three wells were drilled) which drilling crews immediately implemented when the drill string torqued up or encountered a new loss zone. Their quick action and planning prevented the drill string from getting stuck on a number of occasions (Spielman *et al.*, 2006).

Additional prevention measures noted by Ormat include: the use of a Tesco top-drive (essential for back reaming and pumping in the unstable shallow hole) and having round-the-clock on-site geologists (able to provide advanced warning and quick implementation of procedures to maintain control of high pressure steam zones).

## 9.14 Other Advanced Techniques Under Development

### *Reinjection of H<sub>2</sub>S*

A new experimental project at the Hellisheidi geothermal power plant in Iceland is starting to pump hydrogen sulfide extracted from the geothermal steam of the plant operation in an effort to clean its operations (Richter, 2014). This is a research and development project that aims to lower the odor pollution from the plant in an environmental and economically feasible way, according to the company. Reykjavik Energy has built a treatment plant that will extract hydrogen sulfide from the steam output of one of the six units of the Hellisheidi power plant. It was noted that the process is an experimental operation that could create seismic events, however if everything goes according to plan, then the company plans to expand its operations. The company has also been working on a research project that plans to re-inject CO<sub>2</sub> emissions, at its CarbFix project.

### *Drilling Rig Innovation*

InnovaRig is a new drill rig based on the rig type Terra Invader 350 (TI-350) from Herrenknecht-Vertical GmbH with innovative characteristics for scientific drilling and industrial applications (Prevedel *et al.*, 2010). Designed by GFZ Potsdam, Germany's international research center for geosciences, in cooperation with the industrial partners Herrenknecht Vertical and Angers' and Sons drilling company, the InnovaRig has a compact design resulting in a small environmental footprint and reduction in manpower requirements.

The structure of the InnovaRig with a drilling pad foot print of only 29 x 33 feet is extremely compact and allows a flexible arrangement of auxiliary machinery around its core structure. With this flexibility, a total drilling construction area of 0.6 acres (98 feet x 262 feet) can be achieved, which is very favorable for drilling in urban or other difficult-access areas and rather small for a rig with such a depth capacity (InnovaRig has a 350 ton hook load capacity) (Table 9.4). Due to the integration of a comprehensive waste, emission and noise management system, the rig can be operated in urban areas without the need for expensive noise cancellation and protection walls or even rig housing constructions.

The new rig design was used to successfully drill 3 geothermal wells with no major problems reported, demonstrating the innovative designs ability to complete a well with a fraction of typical footprint and noise emissions, and still keep the day rates competitively low (Prevedel *et al.*, 2010).

## **TABLES**



Well	Year Drilled	Total Depth (feet)	BHT (°F)	Operator	Comments	Status*
TH-1	1961	178	130	Thermal Power		
TH-2	1961	556	187	Thermal Power	Abandoned at 350 feet due to loose formation.	
TH-3	1961	690	203	Thermal Power		
TH-4	1961	290	109	Thermal Power	Hole plugged at 98 feet.	
NSF Kilauea (Keller)	1973	4,140	279	Colorado School of Mines / GEDCO	Research well drilled within Hawaii Volcanoes National Park.	Observation
HGP-A	1976	6,456	680	State of Hawaii	Field discovery well; produced about 100,000 lbs/hr of steam and brine; supported 2.8-MW plant from 1981-1989; plugged and abandoned.	P&A
FNB No. 1 (Steamco 1)	1978	6,200		STEAMCO & GEDCO	Drilled by Puuwaawaa Steam Co. (STEAMCO) & Geothermal Exploration and Development Co. (GEDCO); converted to water well in 1980.	Water well
FNB No. 2 (Steamco 2)	1979	6,800		STEAMCO & GEDCO	Drilled by Puuwaawaa Steam Co. (STEAMCO) & Geothermal Exploration and Development Co. (GEDCO); converted to water well No. 4850-01 MW-1 Pin 1980.	Water well
Ashida 1	1980	8,300	550	Barnwell-WRI	Exploratory well - dry; no LCZ encountered; plugged and abandoned; T of 619F noted in Patterson et al. (1994)	P&A
KS-1 (Kapoho-State 1)	1981	7,290	650	Thermal Power	Short test; tested at 3.2 MW; damaged; plugged and abandoned.	P&A
Lanipuna 1 (& Lanipuna 1 Redrill [ST])	1981	8,389	685+	Barnwell-WRI	Low permeability, possible trace of fluids; abandoned. Redrill in 1983; kicked-off at 3570 ft - drilled to 6,271 feet; 429°F maximum recorded at 5300 ft.; no fluids - probably outside reservoir; abandoned.	P&A
KS-2 (Kapoho-State 2)	1982	8,005	670+	Thermal Power	Short test; tested at 2 MW; damaged; plugged and abandoned.	P&A
Lanipuna 6	1984	4,956	335	Barnwell-WRI	Major LCZ below 4,285 feet; coolest hole in field - probably outside reservoir; suspended.	
KS-1A (Kapoho-State 1A)	1985	6,505	670	Thermal Power	17-day flow test; tested at 3 MW; damaged; worked over to deepen and converted to injection service in 1992.	Original Injector
TRUE 1 (also known as KA1-1, TMP-1, KMERZ A-1 and KMERZ-1)	1989-1994	8,741 (A-1 ST) (and other various)	635	True/Mid-Pacific Geothermal	Initial reports of high-pressure steam entries in original vertical hole, plus sidetrack and 3 redrills; TDs include 8,651 ft, 8,741 ft, 7,824 ft, 7,658 ft, and 7,850 ft; steam flows not sustained in flow tests; deepest hole in rift zone; plugged and abandoned.	P&A
SOH 4	1990	6,562	576	State of Hawaii	Maximum reading thermometer = 583°F; no adequate permeability shown by injection in completion interval of 1,991-6,562 feet; may have entered reservoir; plugged and abandoned.	P&A
KAPOHO PUNA MW1 (MW-1)	1990	720	111	PGV	Monitoring / water supply wells	
PUNA GEO MW2 (MW-2)	1991	640	153	PGV	Monitoring / water supply wells	
KS-3	1990-91	7,406	664+	PGV	Short test; tested at 3.2 MW; converted to injection service in 1992.	Original Injector
KAPOHO PUNA MW3 (MW-3)	1991	720	111	PGV	Monitoring / water supply wells	
KS-7	1991	1,678	500+	PGV	Hot pressured fluids vented after injection test at 1,678 feet; plugged and abandoned.	P&A

**Table 1.1: Geothermal Wells Drilled in Hawaii (page 1 of 2)**

Well	Year Drilled	Total Depth (feet)	BHT (°F)	Operator	Comments	Status*
SOH 1	1991	5,526	408	State of Hawaii	Maximum reading thermometer = 403°F; adequate permeability not shown by injection in interval of 4,103-6,802. Some injectate loss at +/-4,600 feet, where 341°F was recorded; probably outside reservoir; plugged and abandoned.	Shut-in. Scheduled for abandonment
SOH 2	1991	6,802	661	State of Hawaii	Inconclusive; may have entered reservoir; funding limits imposed stopping at 5,526 in rising BHT; plugged and abandoned.	Shut-in. Scheduled for abandonment
KS-8	1991-1992	3,488	630+	PGV	Blowout at 3,488 feet in June 1991 vented fluids for 31 hours; completed to production at high-pressure bottom zone; repaired and producing for Puna plant at 10 MW briefly in Oct-Nov 1992; possible casing damage; plugged and abandoned.	P&A
KS-4	1992	6,795	620	PGV	Injection test capacity >860 gpm at zero WHP and 1,100 gpm at 150 psig WHP; completed in November 1992 for injection service; converted to producer in 2006-7; plugged and abandoned in 2009-10.	P&A
KS-9	1992-1993	4,564	647	PGV	Cleaned out and repaired casing damage; flow tested and placed online in April 1993.	Original Producer
KS-10 (& KS-10-RD)	1993	5,083	-	PGV	Original hole abandoned at 200 feet due to stuck bit; slide rig and redrill; put online for production in 1993; attempted to clean out scale in early 2000s - unsuccessful. Plugged back to ~4,700 ft and redrilled in 2005 after production declined starting in 2001; cement squeezed into parted casing at 1,578 feet and casing patch installed; well drilled to major LCZ below 5,154 feet; well put online in 2005 - producing 7.5 MW.	Original Producer (1993-2005); Re-drill is Active Producer
KS-11 (& KS-11 RD)	2000	5,061	-	PGV	Shut-in April 2002 due to casing failure and breakthrough; redrilled in 2003, kicked-off at 4,422 feet and drilled to 7,951 feet; fish left in hole; injection capacity 2,000 gpm at zero WHP; converted to injector after repairs; workover in 2006-7.	Orig. producer (2000-2003); Re-drill is Active Injector
KS-5	2003	6,299	315 (steam T°)	PGV	Completed in January 2003 after KS-11 declined in production from plugging in the wellbore. Surface casing was 22-inch set in 26-inch hole.	Active Producer
KS-13	2005	8,297	-	PGV	Converted to injector in 2006; LCZ began at 109 feet from surface - encountered several LCZ between 4921 and 7218 feet; melt of dacitic composition was encountered at 8,163 feet; injection test capacity 1,700 gpm at 30 psig WHP.	Active Injector
KS-6	2005	6,532	-	PGV	LCZ began at 98 feet from surface - used foam cement for casing strings. Surface casing was 22-inch set in 26-inch hole. LCZ began again at 6,510 feet; well put online in Oct 2005 - producing 8.3 MW.	Active Producer
KS-14	2010	-	-	PGV	Surface casing 22-inch set in 26-inch hole, drilled with foam cement. 11 3/4-inch casing set at 4,878; TD not published.	Active Producer
KS-15	2012	-	-	PGV	22-inch casing to 1,040 feet; 11 3/4-inch casing to 4,705 feet (26-inch hole depth of 4,709 feet); TD not published.	Producer

Source: modified from GeothermEx, Inc., 1994; Patterson *et al.*, 1994b.

Selected references: Rickard *et al.*, 2011a.

\* Status based on most recent publicly available data (see References in Appendix A).

Notations:

TD - total depth

ST - sidetrack

BHT - bottom-hole temperature as measured by wireline tools

P&A - plugged and abandoned

LCZ - lost circulation zone

WHP - wellhead pressure

**Table 1.1: Geothermal Wells Drilled in Hawaii (page 2 of 2)**

Resource Area	Megawatt Capacity	
	10th Percentile	Mean
<b>Kilauea East Rift Zone</b>		
Lower	181	438
Upper	110	339
Total	291	778
<b>Kilauea Southwest Rift Zone</b>		
Lower	64	193
Upper	68	201
Total	133	393
<b>Mauna Loa Southwest Rift Zone</b>	35	125
<b>Mauna Loa Northeast Rift Zone</b>	22	75
<b>Hualalai</b>	7	25
<b>Haleakala Southwest Rift Zone</b>	20	69
<b>Haleakala East Rift Zone</b>	18	70
<b>Totals:</b>		
Island of Hawaii	488	1,396
Island of Maui	38	139
Islands of Hawaii and Maui	525	1,535

Source: GeothermEx, Inc., 2005

**Table 1.2:** Summary of Reserves Estimates for Hawaiian Geothermal Areas

Gas	Concentration (ppmw in steam)	
	HGP-A (separated steam)	Geysers (dry steam)
CO <sub>2</sub>	1200	3260
H <sub>2</sub> S	900	222
NH <sub>3</sub>	0	194
CH <sub>4</sub> , C <sub>2</sub> H <sub>6</sub>	Not Reported	202
N <sub>2</sub>	125	52
H <sub>2</sub>	56	56
He	0.5	Not Reported
Total (ppmw)	2237	3985
Total (wt%)	0.22	0.40
Rd <sup>222</sup> nCi/lb steam	1.5	6.1

Source: Kubacki, 1984

**Table 2.1:** Geothermal Noncondensable Contents

Technical Parameters	Conventional Rig	Improved Conventional Rig	Unconventional Rig
Drilling Depth (m)	<4000	< 4000	< 5000
Hook Load Capacity	150-400 tons	200-450 tons	225-370 tons
Power Packs	Diesel-Electric driven	Electrically driven (including AC-AC Technology)	Electrically driven ( AC Generators & AC Drivers) or fully hydraulic transmission
Structural Height	Double or triple stand	Double or triple stand	Single or double stand
Drilling Rig Automation	Absent/Low	Present/High	Present/High
Automated pipe Handling Equipment	Absent ( Keller Spinner )	Present	Present
Monitoring System	Absent	Present	Present
Noise Pollution	High	Low	Low
Carbon Emission	High	Low	Low
Automatic Braking System	Absent	Present	Present
- Rig up/Rig down time	Longer time		Shorter time
- Mobilisation Cost	Higher cost		Lower cost
- Rig Move for Transportation	35 – 40 loads		22 – 30 loads
Drilling Rigs Pipe Used	3 drill pipes		1or 2 drill pipes
Braking System	Mechanical main brake and Hydraulic Auxiliary brake	Mechanical disk main brake and Hydraulic Auxiliary brake	Regenerative AC or hydraulic brake

**Table 3.1:** Comparison of Conventional and Unconventional Rigs for Geothermal Application (Bello *et al.*, 2013).

Drawworks Hoisting Power rating		Typical Depth Rating		Maximum Hoist Capacity (Hook Load)									
				6 lines		8 lines		10 lines		12 lines		14 lines	
hp	kw	ft	m	lb	ton	lb	ton	lb	ton	lb	ton	lb	ton
550	410	3,000 to 8,500	914 to 2,591	263,000	107	302,800	137	364,500	165				
750	559	7,000 to 12,000	2,134 to 3,658	314,200	143	403,100	183	485,300	220.0				
1,000	746	10,000 to 14,500	3,048 to 4,420			437,300	198	526,700	239	609,500	277		
1,500	1,119	12,000 to 18,000	3,658 to 5,486					708,100	321	819,300	372	922,900	419
2,000	1,864	13,000 to 25,000	3,962 to 7,620					919,200	417	1,064,100	483	1,198,600	544
3,000	2,237	16,000 to 30,000	4,877 to 9,144							1,484,360	673	1,671,960	756

**Table 3.2:** Typical Rig Sizes (Ngugi, 2008).

	Salton Sea, California	Broadlands 1, New Zealand	Hot Springs, Utah	Kilauea, Hawaii	Krafla, Iceland	Kizildere (W15), Turkey	Klamath Falls, Oregon	Dogger, Paris Basin, France	Nigrita, Greece
pH	5.7	8.3	-	7.1	7.2	8	8.4	6.2	6.8
TDS (g/L)	182	3.8	7.4	15.8	1	2.4	0.7	7	2.5
Na	42,700	1,060	2,320	4,930	193	1,192	205	3,700	529
K	6,500	150	461	756	20	135	4.3	60	89
Ca	18,200	5	8	358	1.5	1.9	26	630	160
Mg	570	0	2	0.3	0.03	0.2	0.5	150	105
Fe	180	0.2	1	0	0.02	0	0.3	0.5	1.1
Pb	59	-	-	0	0	-	-	-	-
Cl	112,000	1,700	3,860	8,970	26	46	51	7,980	162
SO <sub>4</sub> <sup>2-</sup>	6	40	72	24	194	631	330	775	130
HCO <sub>3</sub> <sup>-</sup>	220	300	232	18	328	-	35	335	2,200
As	22	5	4	0.1	-	-	-	-	0.5
B	480	7	-	4.3	-	24	-	5	4.6
SiO <sub>2</sub>	1,150	600	563	750	383	356	48	14	38

Source: after Ungemach, 2010

\* Concentrations are in mg/L.

**Table 3.3:** Characteristics and Compositions of Typical Geothermal Wells.

ITEM	SLIM HOLE	CONVENTIONAL ROTARY WELL	COMMENTS/NOTES
Rig Depth Capacity (drilling core rod size)	>8,000'(HQ) >10,000'(NQ)*	10,000'-15,000'+	
Capital Equipment Costs (Rig Cost)	\$1 mil	>\$8 mil	
Drilling Location Size Required	100' X 100' (10,000 sq ft)	400' X 400' (160,000 sq ft)	16 fold increase needed with the conventional rotary rig
Permitting Issues	Low Impact	More challenging	
# of Truckloads	4-6	35+	Note slim hole 'portability'
Mobilization/Move, Rig-up Time	1 day	4 days	
Relative Mobilization Cost	\$8k	\$100k	Difference becomes much greater in International or remote locations
Roads/Access Required	No improvement required, possible air-lift	Improved roads re-quired, heavy load requirements	
# of Crew Members/Tour	3	5*	*Additional 3-5 support personnel on site
Bits/Trips	Diamond core bits; long life, fewer trips	Conventional insert, PDC bits; trips every 2-3 days	Long life with diamond core bits, even at high coring rpm
Mud Systems (Total Volume)	100-150 barrels	1,700 barrels	7,000' depth, 3" core hole vs. 12 ¼" rotary hole
Mud System Costs	\$1,200/day	\$2,500/day	Dependent on hole conditions
Mud Mixing/Solids Removal Equipment	Minimal, shaker, hydrocyclones	Extensive – shakers, desilter, centrifuge	Mud cooler occasionally required
Mud Volume in Annulus	20% of hole volume	>90% of hole volume	Annular space differences (0.25" in coring operations)
Equivalent circulating density (ECD) Issues, Surge/Swab	Extreme ECD, surge/swab	Low	Annular space
Drilling Ratty Hole	Challenging	Relatively manageable	Annular space issues
Coring Capability	Continuous	Occasional short core intervals	Rotary not set up for continuous coring
Rate of Penetration (ROP)	5-12 fph average	15-25 fph average	
Lost Circulation	Core ahead blind	Cure with LCM, except for production interval	
Cementing	Low volumes	High volumes	Annular conditions
Casing Costs	Low (4-4.5" casing, HQ*, NQ** rod)	High cost – large diameter API casing	Large diameter required for rotary holes
Rotary RPM	400-2,200	60-100	
Typical Cost/Day	\$18k-\$20k	\$65k-\$70k	Based on 7,000' wells
Typical Cost/Foot	\$140-\$225	\$425-\$650	Based on 7,000' wells
Typical Cost/Well	\$1-1.6 mil	\$3.0-\$5+ mil	Slim hole ~30-35% of rotary well costs

Source: after Tuttle, *et al.*, 2010

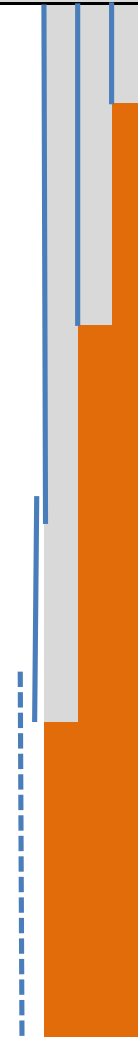
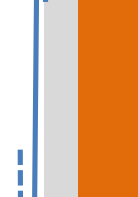

\* HQ and NQ drilling rod sizes for core holes. See *drilling rods* in Appendix B.

**Table 3.4:** Cost and Size Comparison of Hydraulic Diamond Core Drills (Slim Holes) vs. Conventional Rotary Rigs (Large Holes).



Weight	(specific gravity)
pH	-
Marsh viscosity	(seconds)
Plastic viscosity	(cp)
Yield point	lbs/100 sq.ft.)
10 min Gel	lbs/100 sq.ft.)
Water loss	(volume/minute)
Wall cake	(inches)
Sand content	%

**Table 3.5:** Important Dispersed Mud Properties and Their Units.

Hole Size (inches)	Casing Size (Inches)	Drilled Depth (feet)	Fluid Type	Fluid Properties		Product	Formulation (ppb)	Function
	 <div style="display: none;">           A diagram showing a vertical hole and casing. The hole is represented by a dashed blue line. The casing is a solid blue line. The hole size is larger than the casing size.         </div>							
	 <div style="display: none;">           A diagram showing a vertical hole and casing. The hole is represented by a dashed blue line. The casing is a solid blue line. The hole size is larger than the casing size.         </div>							
	 <div style="display: none;">           A diagram showing a vertical hole and casing. The hole is represented by a dashed blue line. The casing is a solid blue line. The hole size is larger than the casing size.         </div>							
	 <div style="display: none;">           A diagram showing a vertical hole and casing. The hole is represented by a dashed blue line. The casing is a solid blue line. The hole size is larger than the casing size.         </div>							
	 <div style="display: none;">           A diagram showing a vertical hole and casing. The hole is represented by a dashed blue line. The casing is a solid blue line. The hole size is larger than the casing size.         </div>							

**Table 3.6:** Drilling Fluids Proposal Template.

Casing Grade*		Temperature (°C)			
		20	100	200	300
	<b>API Yield Strength (Factor)</b>				
	J/K-55	1.00	0.95	0.95	0.95
	N-80	1.00	0.96	0.92	0.88
	<b>Tensile Strength (Factor)</b>				
	J/K-55	1.00	0.97	1.02	1.07
	N-80	1.00	0.97	0.99	0.99
	<b>Modulus of Elasticity (10<sup>3</sup> Mpa)</b>				
	J-55	178	172	168	160
	K-55	208	208	200	192
	N-80	206	206	200	192

Source: New Zealand Standard, 1991

\* See Table 4.2 for definition of casing grade properties

**Table 4.1:** Casing Properties under Various Temperature Conditions.

Casing Grade <sup>†</sup>	Minimum Yield Strength (psi) <sup>‡</sup>	Maximum Yield Strength (psi)	Minimum Tensile Strength (psi)	Comments
H-40	40,000	80,000	60,000	General purpose pipe manufactured to API specification 5CT. H-40 is generally not used in tubing sizes because the yield strength is relatively low and the cost saving over J-55 is minimal. Suppliers do not commonly stock this grade.
J-55	55,000	80,000	75,000	General purpose pipe manufactured to API specification 5CT commonly used for most wells. Similar to K-55 except the minimum tensile strength is lower. Some operators recommend it be full-length normalized or normalized and tempered after upsetting when used when CO <sub>2</sub> or sour gas (H <sub>2</sub> S) is present; however, such heat treatments increase costs. Usually, this grade is used in tubing applications
K-55	55,000	80,000	95,000	General purpose pipe manufactured to API specification 5CT. Usually, this grade is used in casing applications
L-80	80,000	95,000	95,000	Manufactured to API specification 5CT. This is a controlled yield strength material with a hardness testing requirement. L-80 is usually used in wells with sour gas (H <sub>2</sub> S) environments as it is satisfactory for sulphide stress corrosion (SSC) resistance.
C-75	-	-	-	No longer an official API grade and generally not available. It was developed as a higher-strength material for sour service but was replaced by L-80 tubing.
T-95	95,000	110,000	105,000	A high-strength tubular grade that has different chemical requirements: Type 1 and Type 2. Only Type 1 is recommended for sour service. T95 is SSC resistant but not weight-loss resistant
C-90	90,000	105,000	100,000	A relatively new API grade with two different chemical requirements: Type 1 and Type 2. Only Type 1 is recommended for use in sour service. Typically, this grade must be special ordered; its use has been generally supplanted by T95.

Sources: API, 2005; Standard New Zealand, 1991; API, 2011; Hossein-Pourazad, 2005; Equip Outlet, Inc., 2014.

\* API SPEC 5CT has replaced API SPEC 5A

† Numbers in the grade designation indicate the minimum yield strength of the steel in thousands of psi.

‡ API defines the yield strength as the tensile stress required to produce a specific total elongation per unit length on a standard test specimen.

**Table 4.2:** Strength Requirements of Casing Pipe Manufactured in Accordance with API Specification 5CT\*.

<b>Well/Production Data</b>	<b>Estimated</b>	<b>Actual</b>
Temperature Encountered	650°F	618°F
Steam Production	600,000 lb/hr	600,600 lb/hr
Steam Flow	90%	78%
Liquid Flow	10%	22%
Total Mass Flow	670,000 lb/hr	770,000 lb/hr

Source: Bour and Rickard, 2000.

**Table 4.3:** Expected Downhole Conditions vs. Actual Downhole Conditions of Well KS-11.

<b>CaP Cement</b>	<b>Foamed Cement</b>	<b>Latex Cement</b>
CO <sub>2</sub> resistant	Gas migration control	Slows CO <sub>2</sub> attack
Not subject to corrosion	No free water	Improved acid resistance
Good bonding properties	Improved displacement	Improved bonding
Does not shrink	Low fluid loss	Fluid-loss control
Not subject to strength retrogression	Ductility	Increased resiliency
Tested at 700°F	Variable density	Excellent wetting properties
	Energized	
	Light weight	

Source: Hernandez and Nguyen, 2010.

**Table 4.4:** Cement Properties for Geothermal Cements.

(1 bar = 100 kPa)

	1	2	3	4	5	6	7	8	9
	Temperature °F (°C)								
	-20 to 250 (-29 to 121)	300 (149)	350 (177)	400 (204)	450 (232)	500 (260)	550 (288)	600 (316)	650 (343)
Maximum Working Pressure psi (Bar)	2000 (138.0)	1955 (134.8)	1905 (131.4)	1860 (128.2)	1810 (124.8)	1735 (119.6)	1635 (113.7)	1540 (106.2)	1430 (93.6)
	3000 (207.0)	2930 (202.0)	2880 (197.2)	2785 (192.0)	2715 (187.2)	2605 (179.6)	2455 (169.3)	2310 (159.3)	2145 (147.9)
	5000 (345.0)	4980 (336.5)	4765 (323.5)	4645 (320.3)	4525 (312.0)	4340 (299.2)	4090 (232.0)	3850 (285.5)	3575 (246.5)

Source: Patterson *et al.*, 1994a.

The maximum recommended working pressure ratings are applicable to steel parts of the wellhead shell or pressure containing structure, such as bodies, bonnets, covers, end flanges, metallic ring gaskets, welding ends, bolts, and nuts for metal temperatures between -20°F and 650°F (-29°C and 343°C). These ratings do not apply to any non-metallic resilient sealing materials or plastic sealing materials.

**Table 5.1:** Pressure-Temperature Ratings of Steel Parts (Patterson et al., 1994a).

Case	Bit Type	Bit	Scenario	Bit Cost, BC [\$]	ROP [ft/hr]	Footage Drilled, L [ft]	Initial Depth, ID [ft]	Drilling Time, DT [hr]	Trip Time [hr]	Cost Per Foot [\$/ft]	Interval cost [\$k]
A	PDC	Bit 1	Actual performance	\$15,000.00	26.5	725	1345	27.4	2.1	\$ 45	\$32,780
B	Roller Cone	Bit 3	if Bit 3 drilled the Bit 1 interval	\$ 3,200.00	10	400	1345	40.0	1.7	\$ 71	\$52,507
				\$ 3,200.00	10	325	1745	32.5	2.1	\$ 74	
C	PDC	Bit 2	DBR	\$46,888.00	20.4	566	2070	27.7	2.6	\$ 115	\$65,243
D	PDC	Bit 2	Adequate rig torque - no DBR	\$15,000.00	20.4	566	2070	27.7	2.6	\$ 59	\$33,355
E	Roller Cone	Bit 3	if Bit 3 drilled the Bit 2 interval	\$ 3,200.00	10	400	2070	40.0	2.5	\$ 72	\$43,681
				\$ 3,200.00	10	166	2470	16.6	2.6	\$ 89	

\* ROP (Rate of Penetration); DBR (Damaged Beyond Repair).

**Table 9.1:** Rock Reduction Component of Drilling Costs (Raymond *et al.*, 2012).



Consumable Items	Amount Used
Foaming Agent A	18 ea - 55 gal drums
Foaming Agent B	82 ea - 5 gal buckets
Drilling Detergent (MD*)	24 ea -5 gal Buckets
PHPA** liquid	12 ea - 5 gal Buckets
Xanthan Gum polymer	35 ea - 25 lb Sacks
Hydrated Lime	10 ea - 50 lb Sacks

Source: Rickard *et al.*, 2011a

\* MD (mud detergent)

\*\* PHPA (partially hydrolyzed polyacrylamide)

**Table 9.2:** Consumables Used in Aerated Mud Program at KS-14.

Product	Description	Function	Concentration (PPB)
Gel	Bentonite	Viscosity and fluid loss	10 to 20 ppb
HT Polymer Deflocculant – Bentonite Stabilizer	Sodium salt of sulfonated styrene maleic anhydride copolymer (SSMA) or a derivatized synthetic interpolymer	Deflocculation, high temperature stabilization and contamination resistance	0.2 to 0.5
HT-HP Copolymers	Vinyl sulfonated copolymer	HT Filtration Control and Viscosity	0.25 to 2.0
HT Lignite	HT Lignite copolymer blend	HT Filtration Control	0.5 to 3.0

Source: Rickard *et al.*, 2011b

Note: Both the SSMA and vinyl sulfonated copolymers are also effective at maintaining properties even when exposed to contamination such as carbon dioxide, brine and cement.

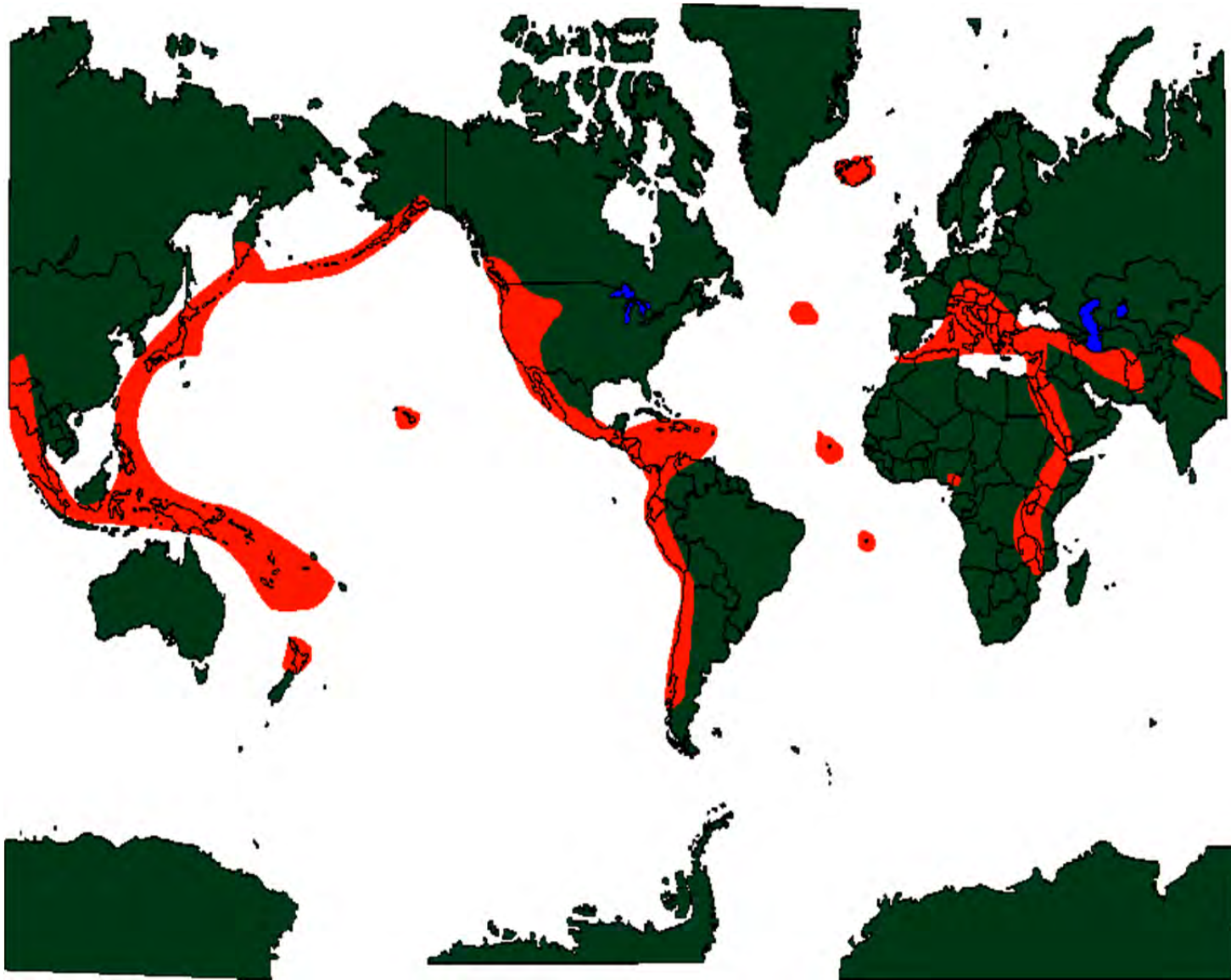
**Table 9.3:** Fluid Formulation for High Temperature Wells.

Drilling depth	4000–5000 m
Regular hook load	3500 kN
Nominal rotary speed	220 rpm
Rotary torque	40 to 75 kNm
Wireline coring speed	500 rpm
Wireline coring torque	12 to 18 kNm
Tripping speed	500 m/hr
Hoist cylinder stroke	22 m
Drive power up to	4000 kW
Rig weight approx.	3700 kN
Mud pumps	3 x 1000 kW
Wireline coring mud	1 x 600 kW
Mud pressure max.	350 bar
Mud tank system	240 m <sup>3</sup>
Generator set	3 x 1540 kVA
Drill pipe rack capacity	7000 m
Wireline coring winch	5000 m, d=12.7 mm

\* kN (kilonewtons); kNm (kilonewton meter)

**Table 9.4:** InnovaRig specifications (Prevedel *et al.*, 2010).

## **FIGURES**



**Figure 1.1:** Hottest geothermal regions worldwide (GEO, 2014).

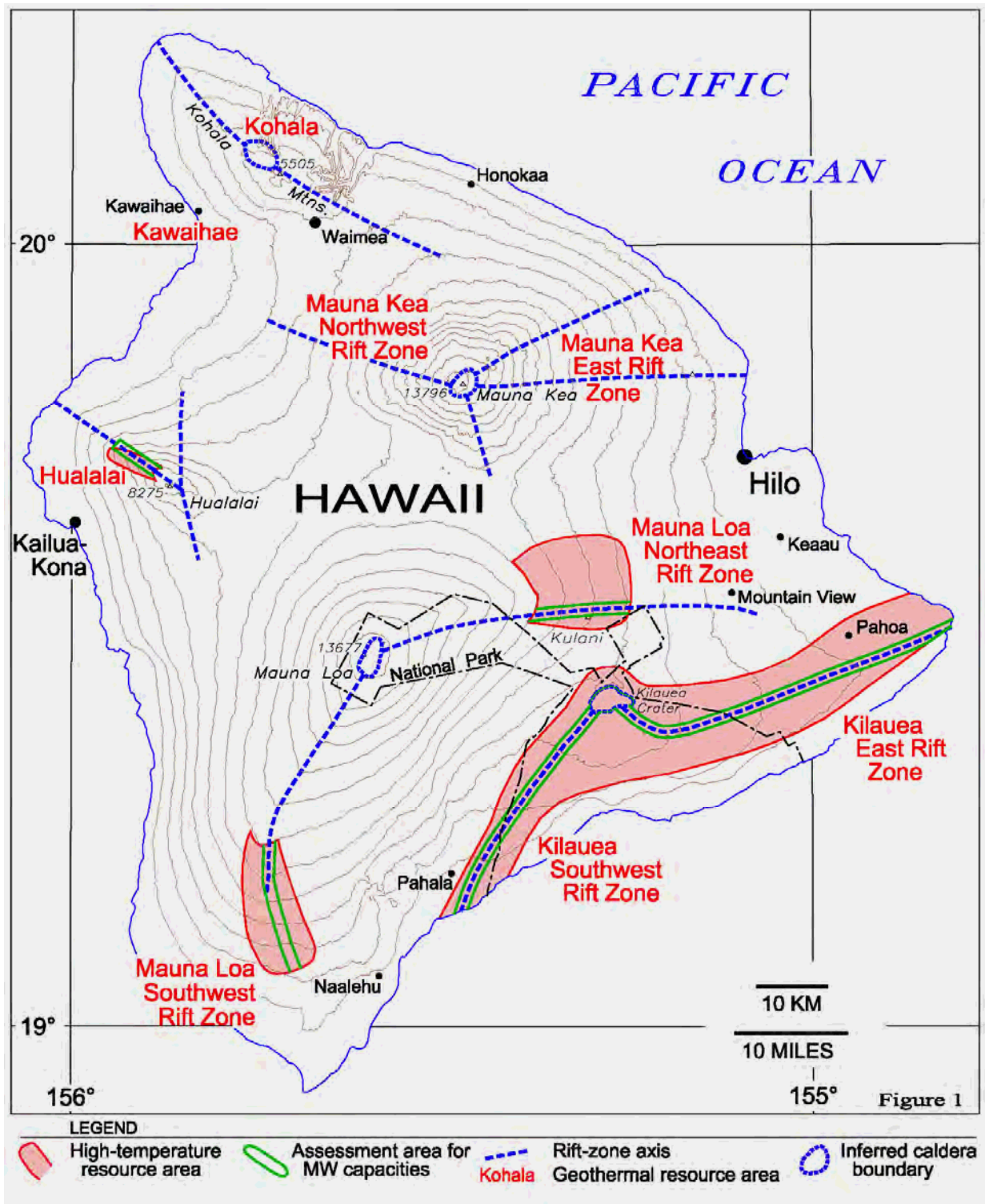
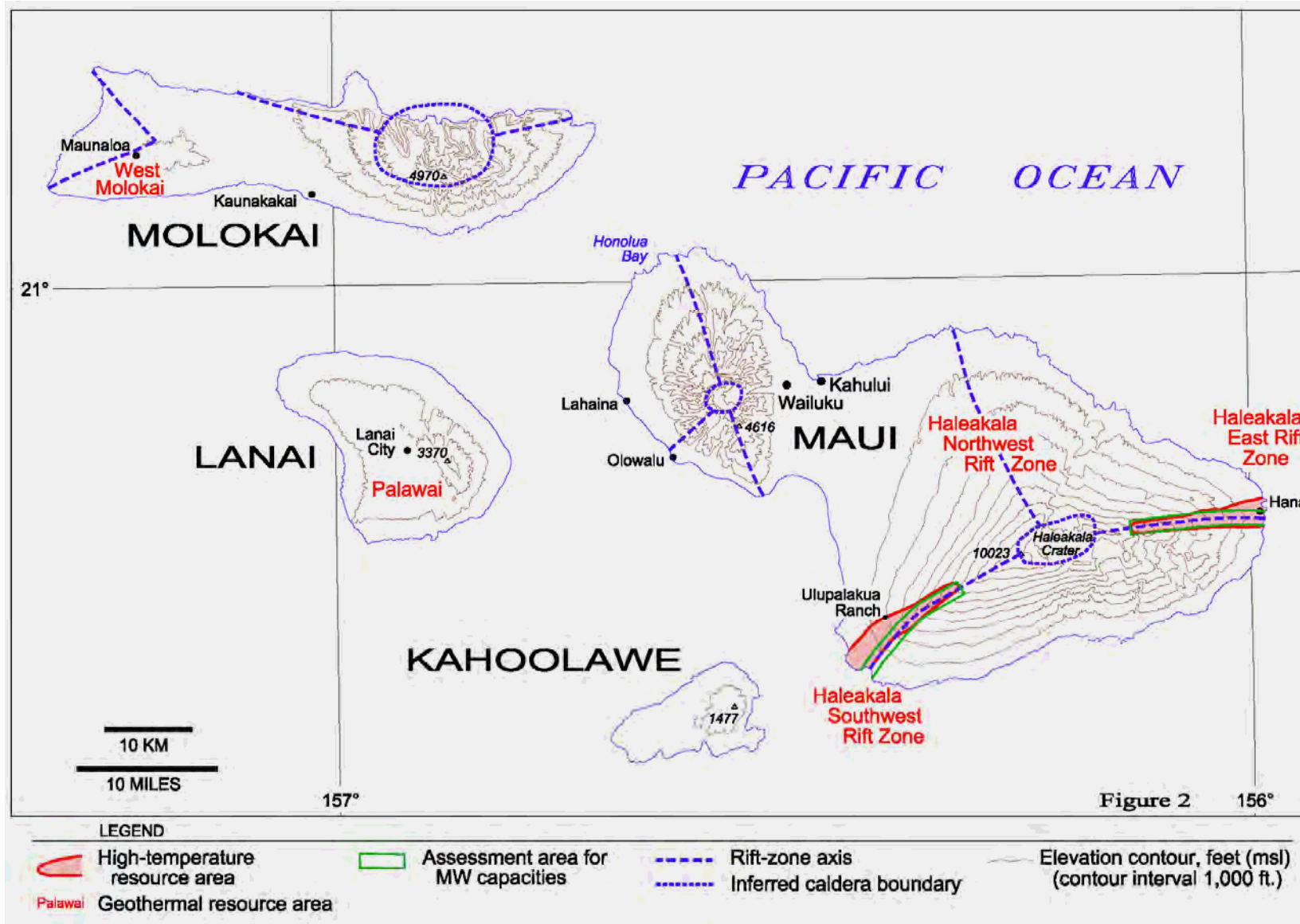
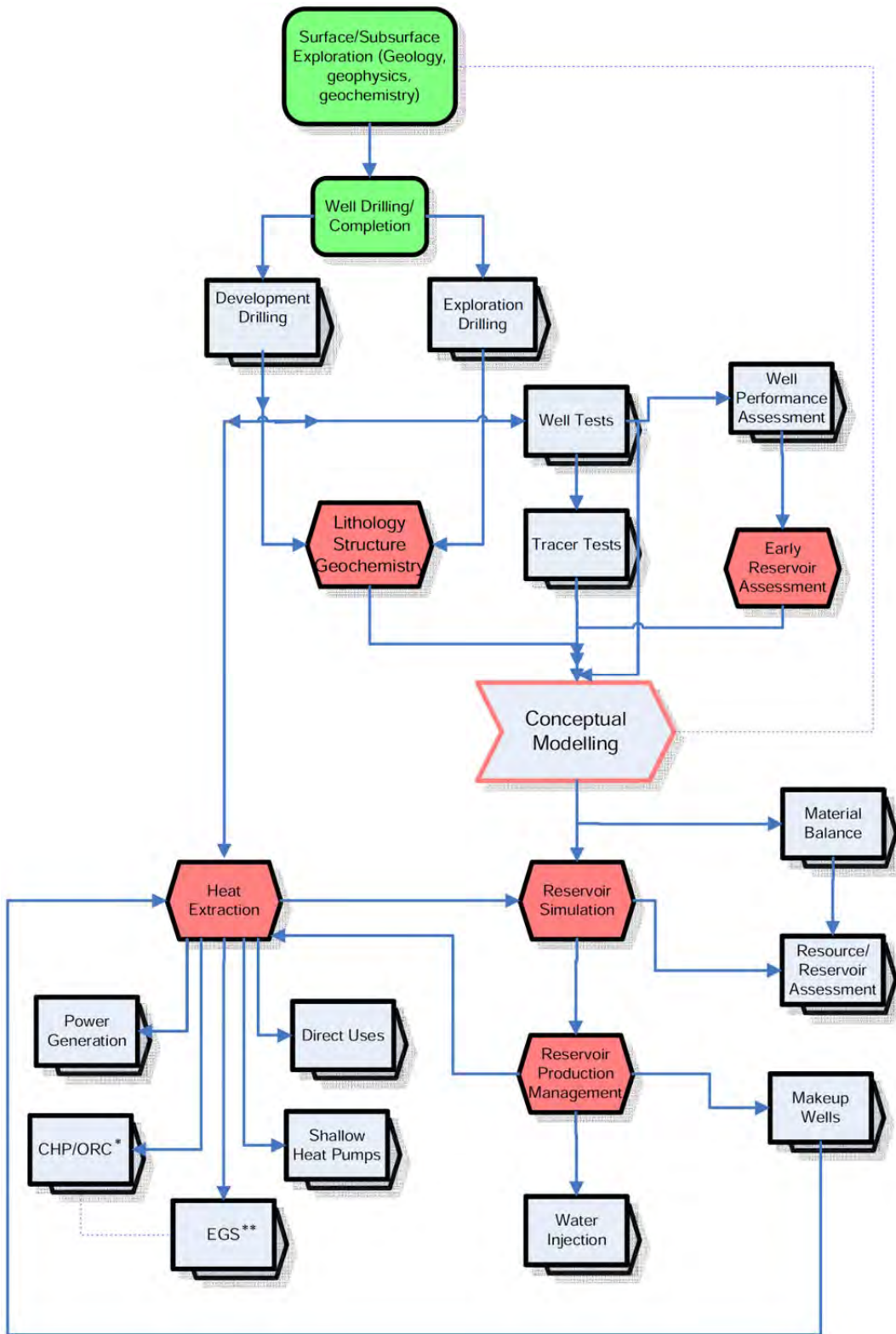


Figure 1.2: Geothermal resources of Hawaii County (Lovekin *et al.*, 2006).



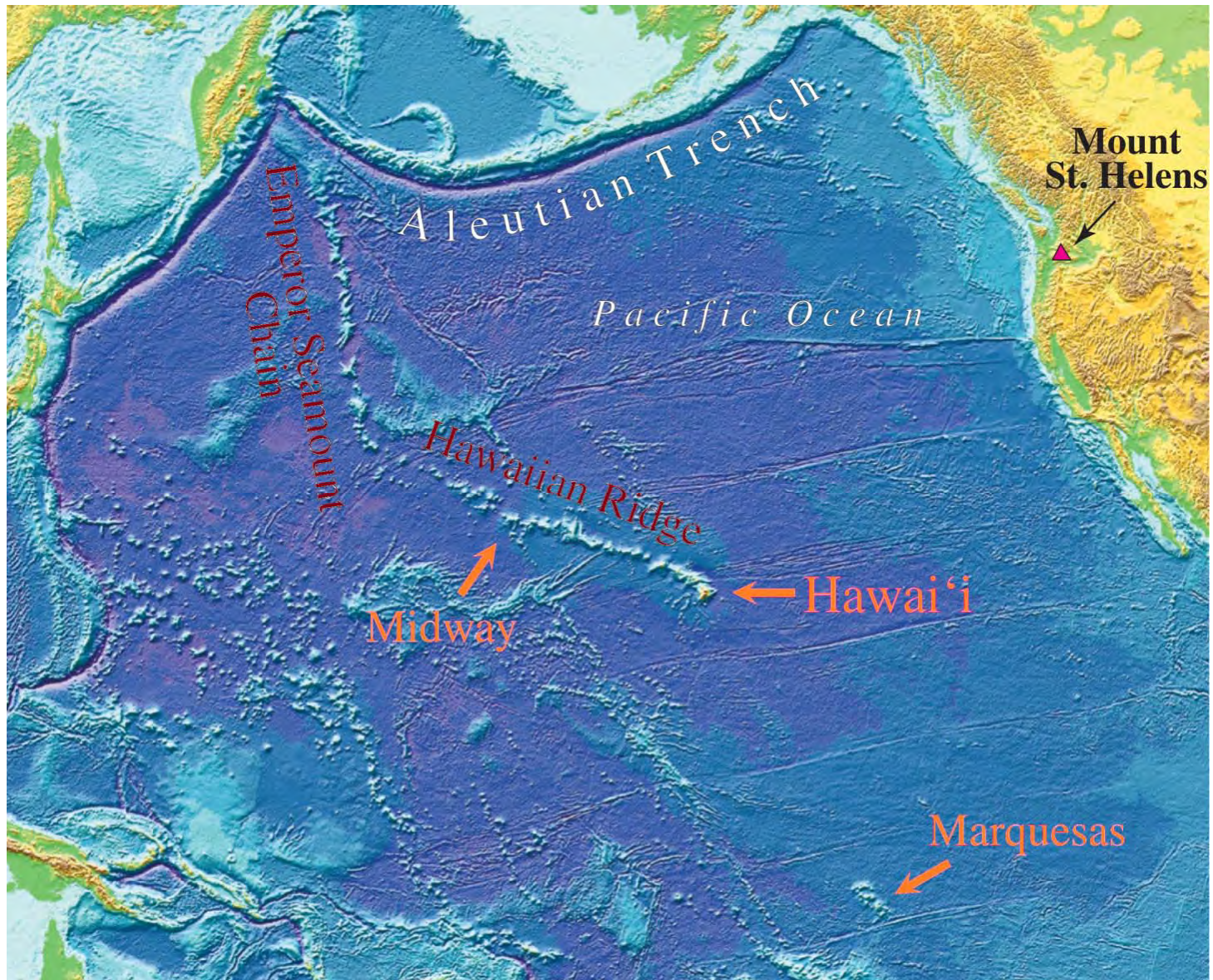
**Figure 1.3:** Geothermal resources of Maui County (Lovekin *et al.*, 2006).



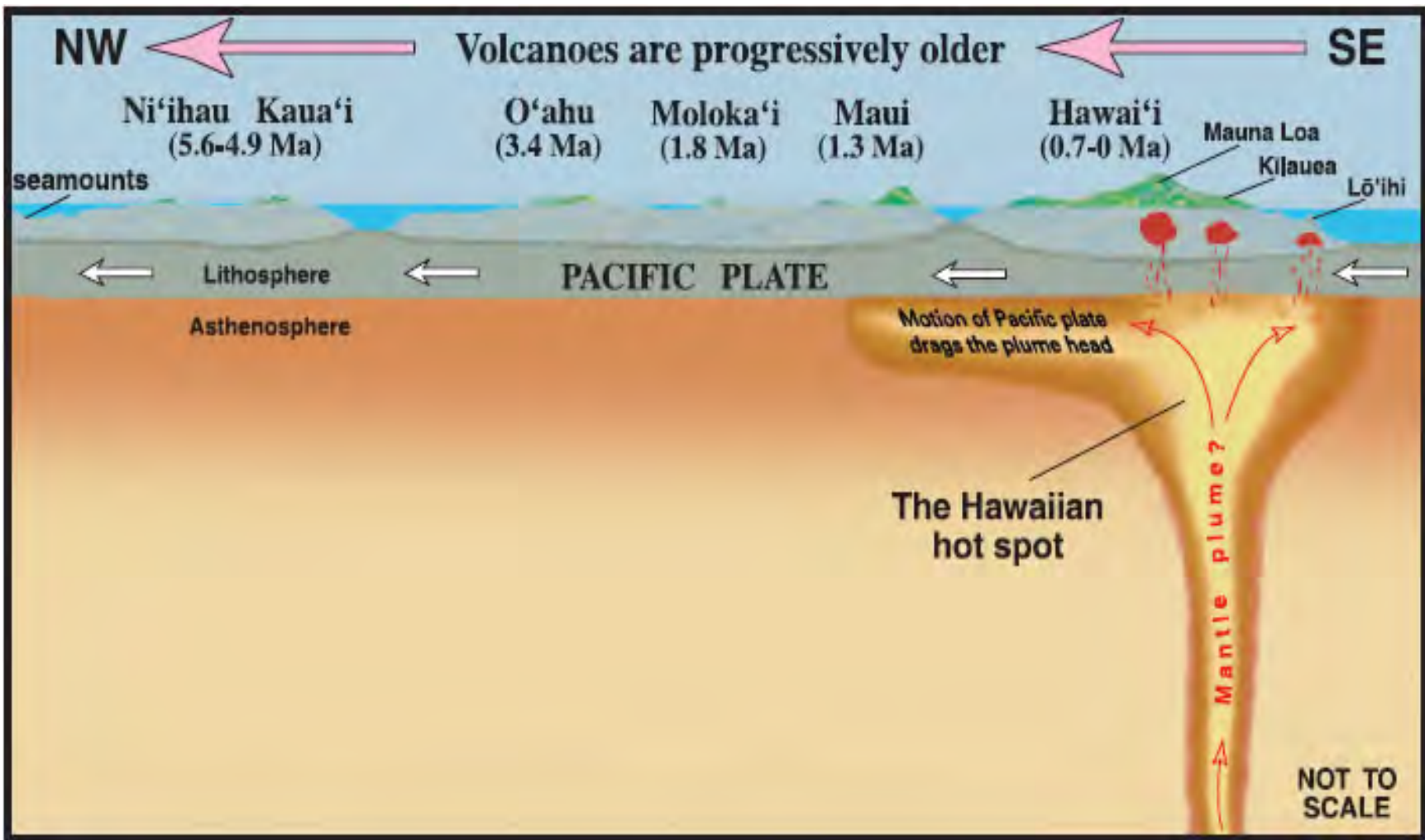
\* Combined Heating and Power / Organic Rankine Cycle; \*\* Enhanced Geothermal System.

Figure 1.4: Geothermal project development process flowchart (Ungemach, 2010).





**Figure 1.5:** Map of the Pacific Basin showing the location of the Hawaiian Ridge and Emperor Seamount Chain (Tilling *et al.*, 2010).



**Figure 1.6:** Cross-section view of the Hawaiian Ridge showing mantle plume at depth (Tilling *et al.*, 2010).

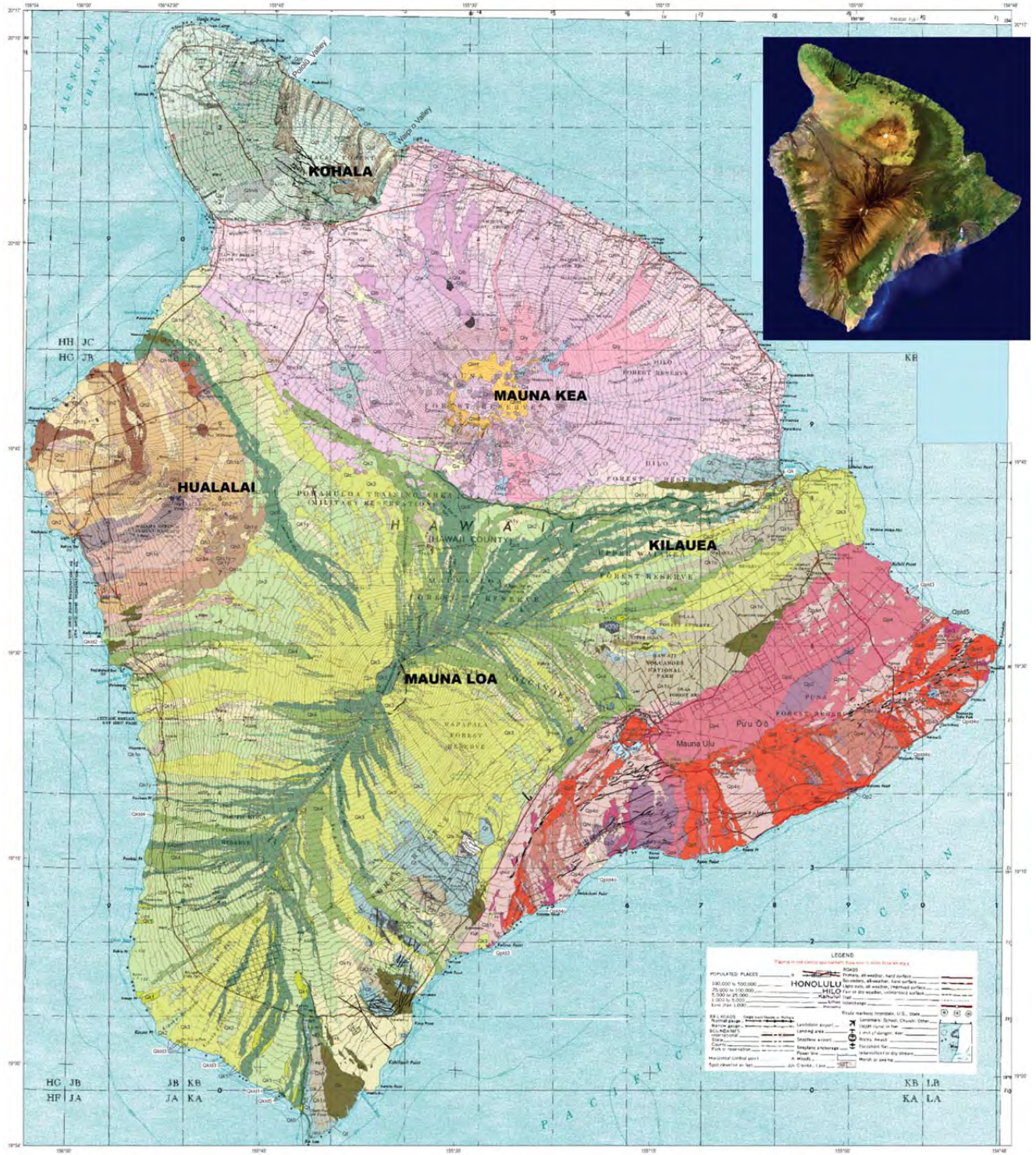
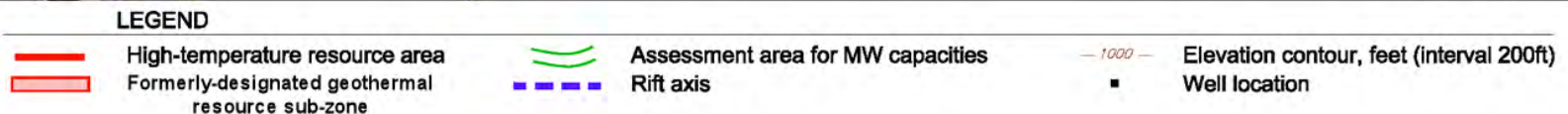
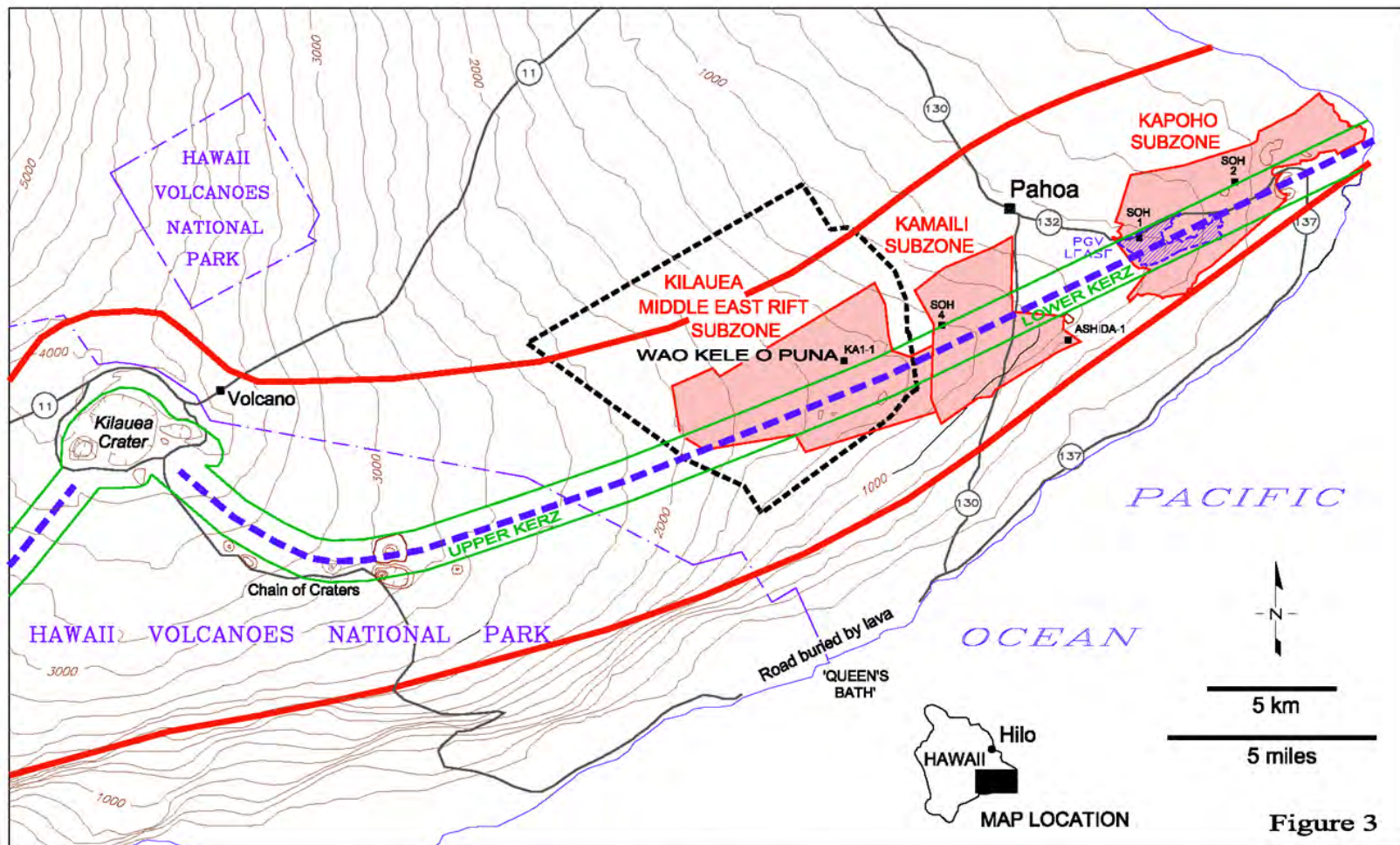
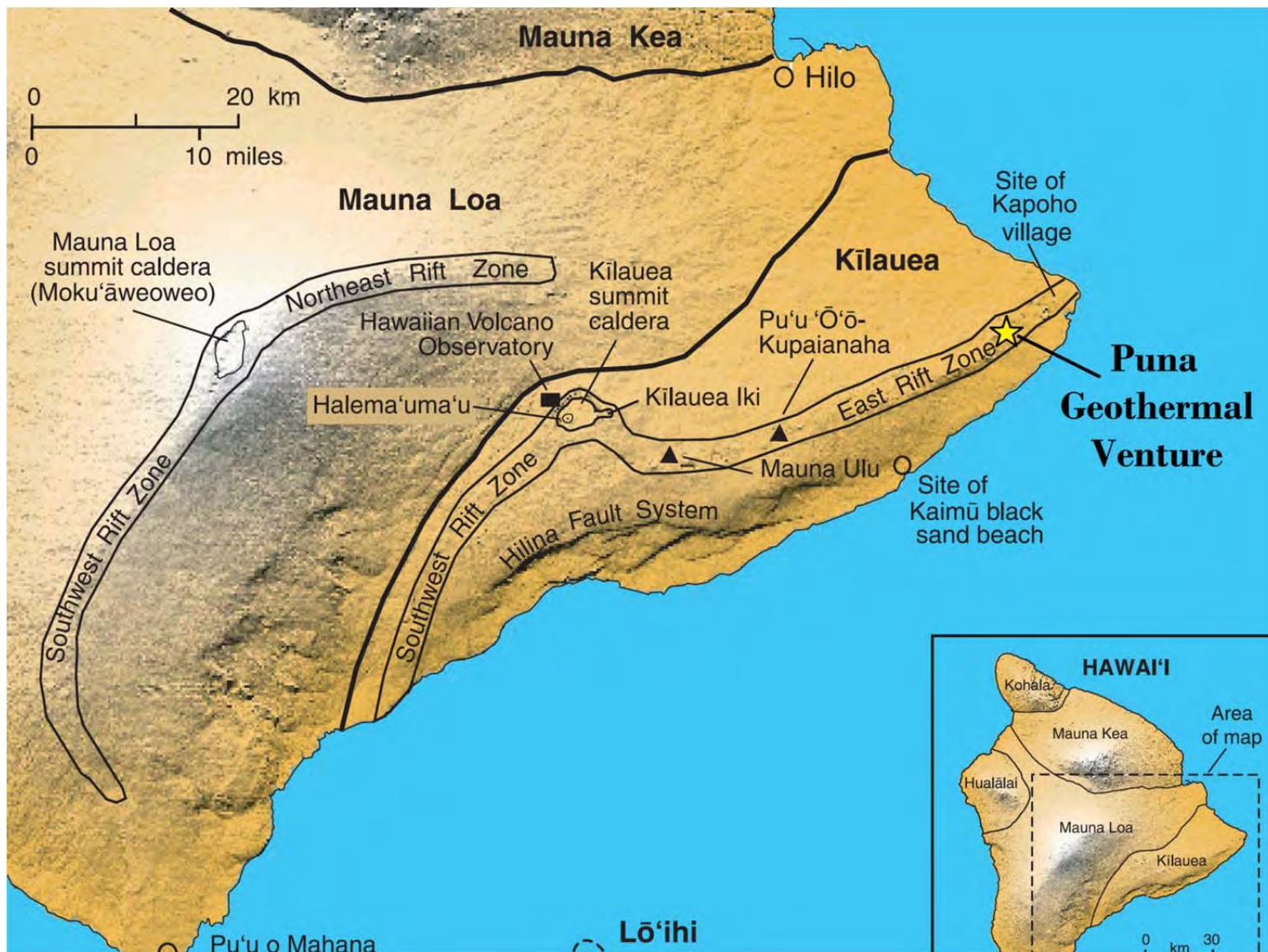


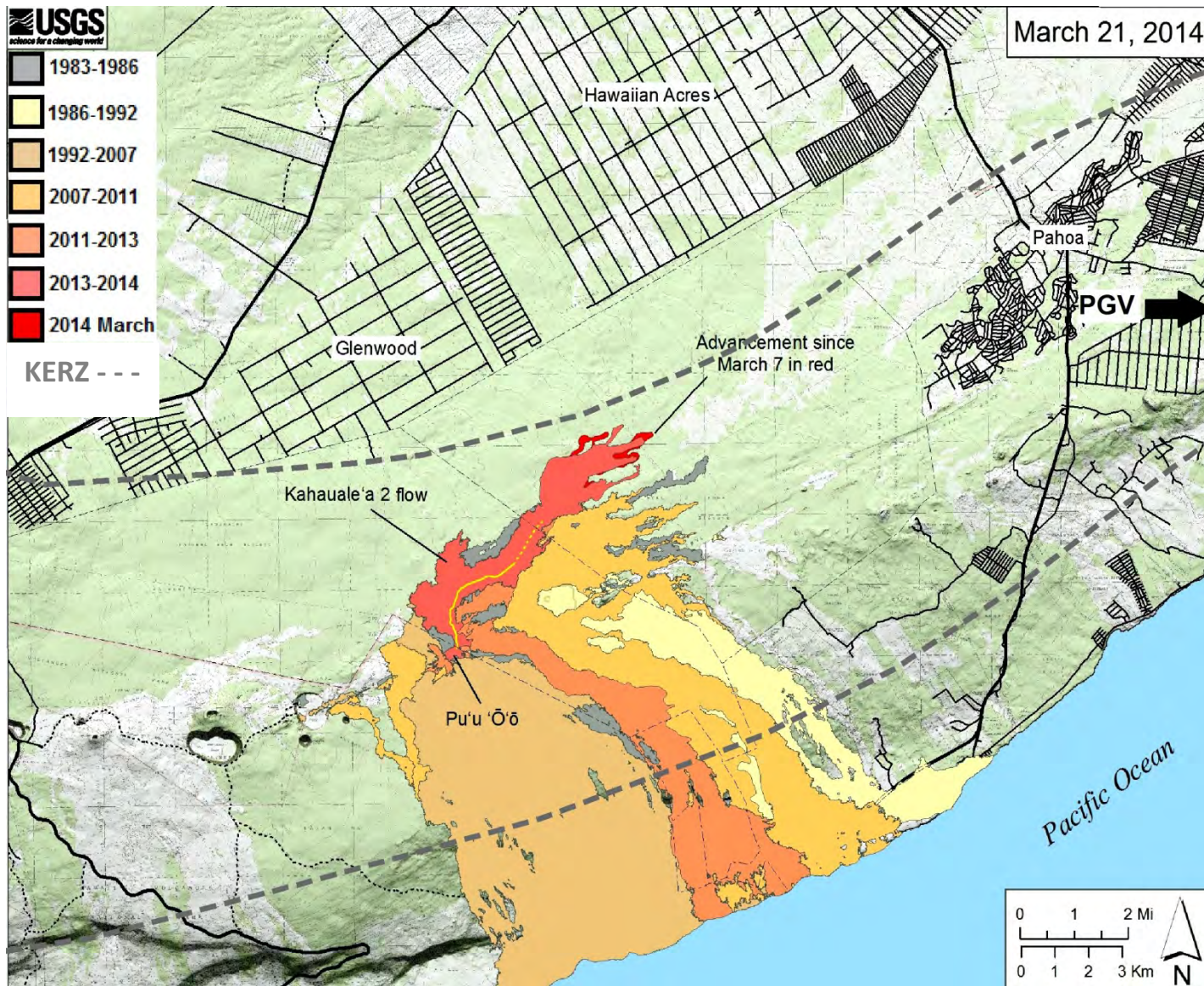
Figure 1.7: Geologic map of Hawaii County (Sherrod *et al.*, 2007).



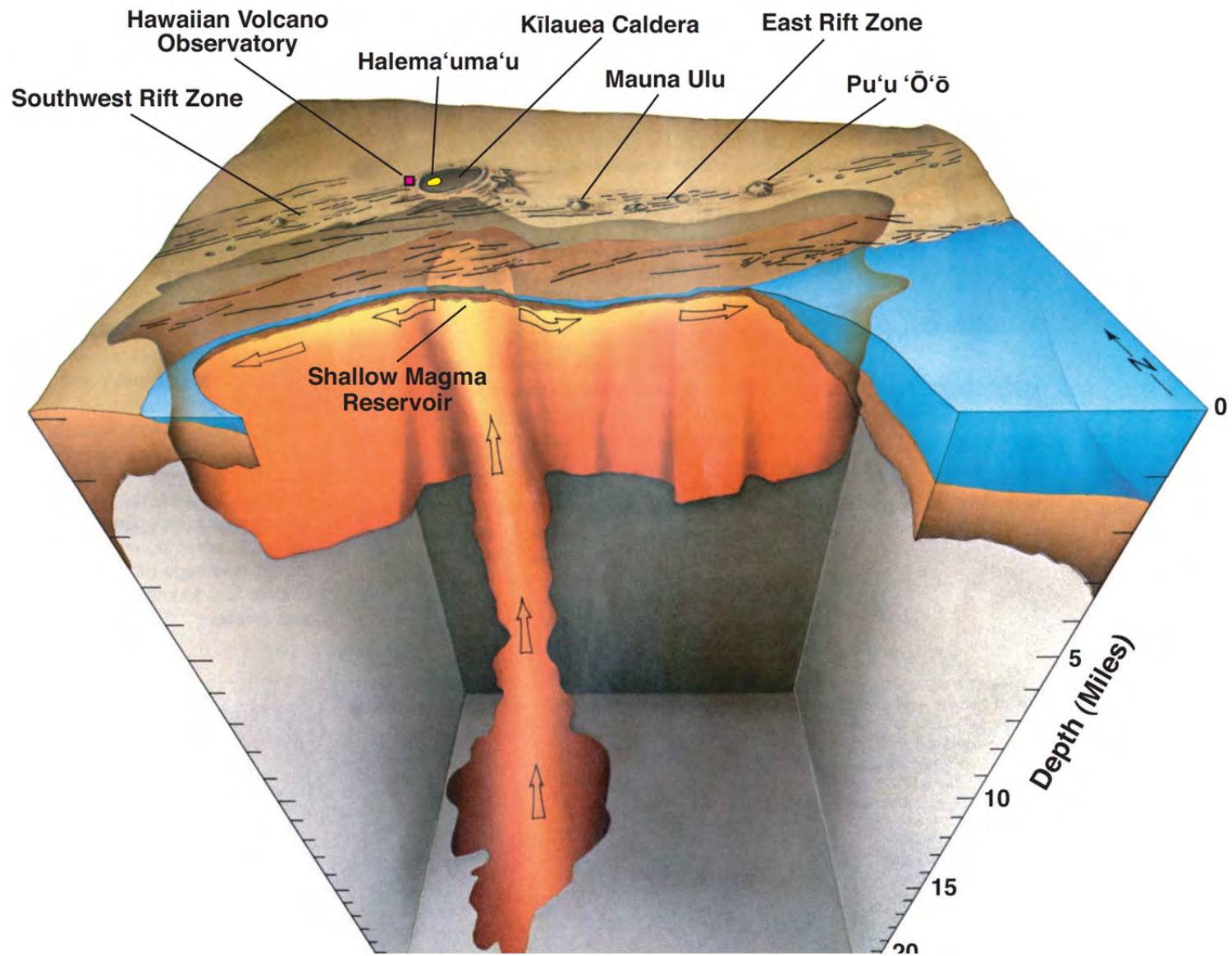
**Figure 1.8:** Kilauea East Rift Zone (Lovekin *et al.*, 2006).



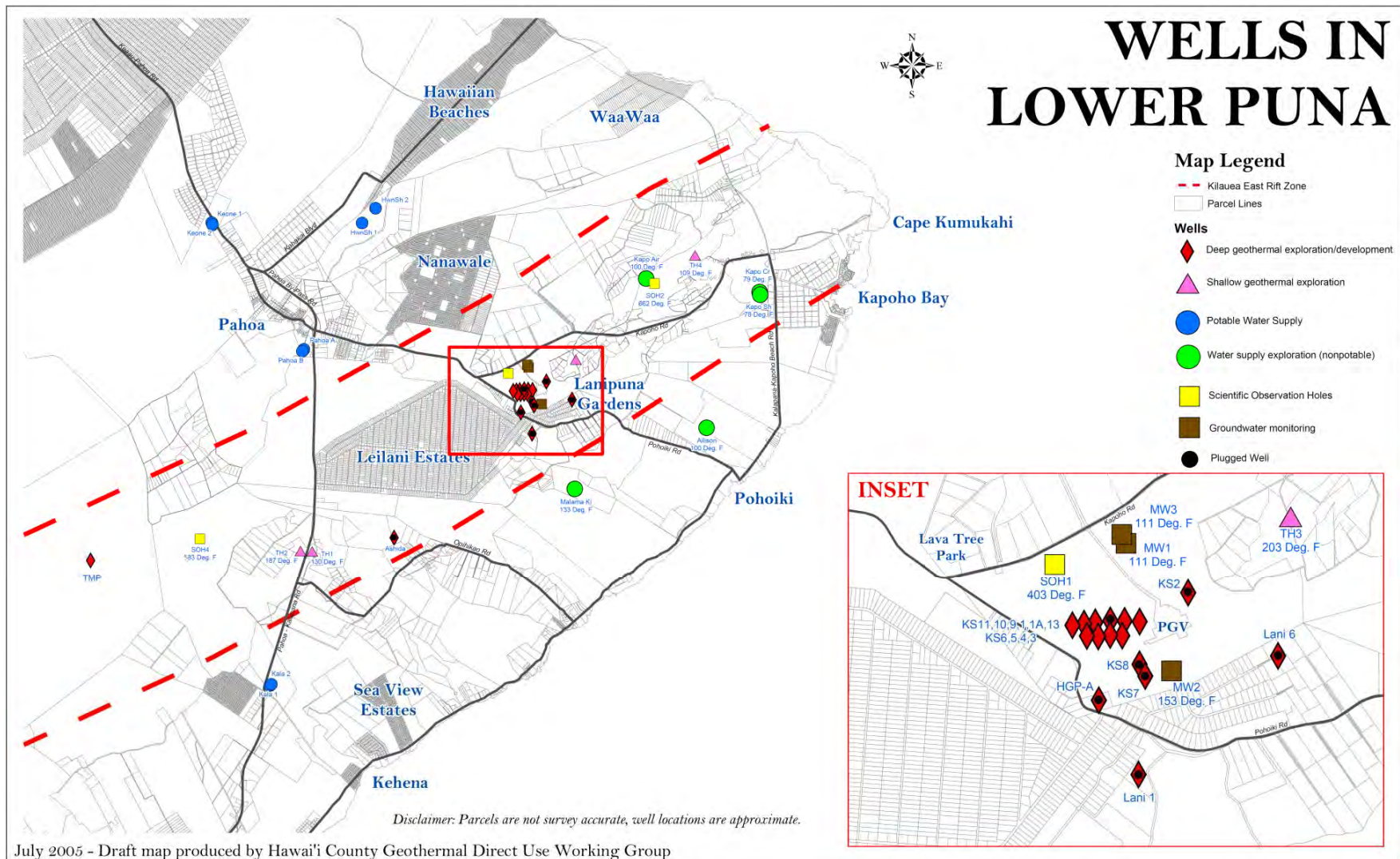
**Figure 1.9:** Shaded relief of the KERZ showing principle volcanic features and the location of Ormat's Puna Geothermal Venture (Tilling *et al.*, 2010).



**Figure 1.10:** Map showing Kilauea's vent (Kahauale'a 2) flow as of March 21, 2014 (after USGS, 2014b).

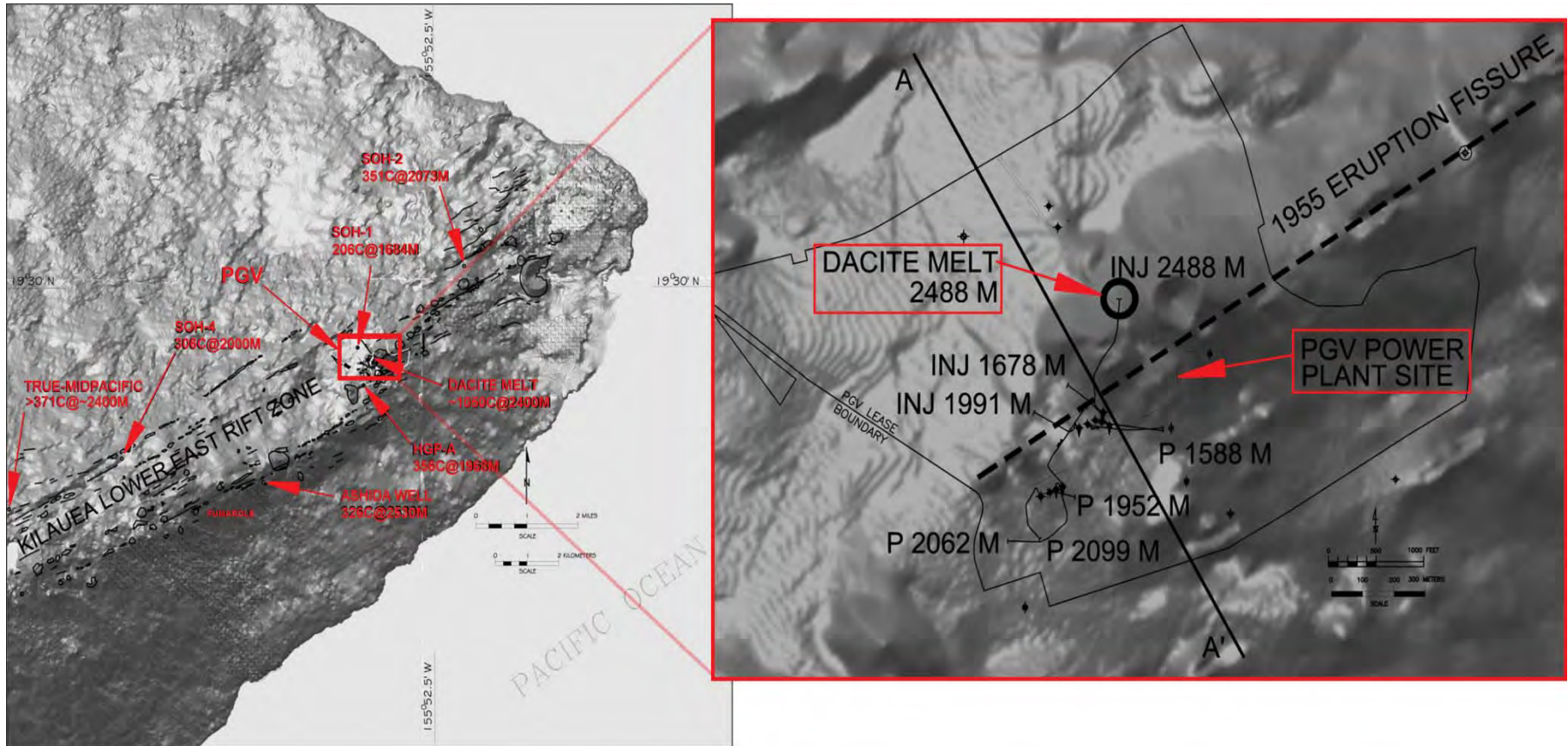


**Figure 1.11:** Cutaway view of magma pathway and shallow reservoir beneath Kilauea (Tilling *et al.*, 2010).

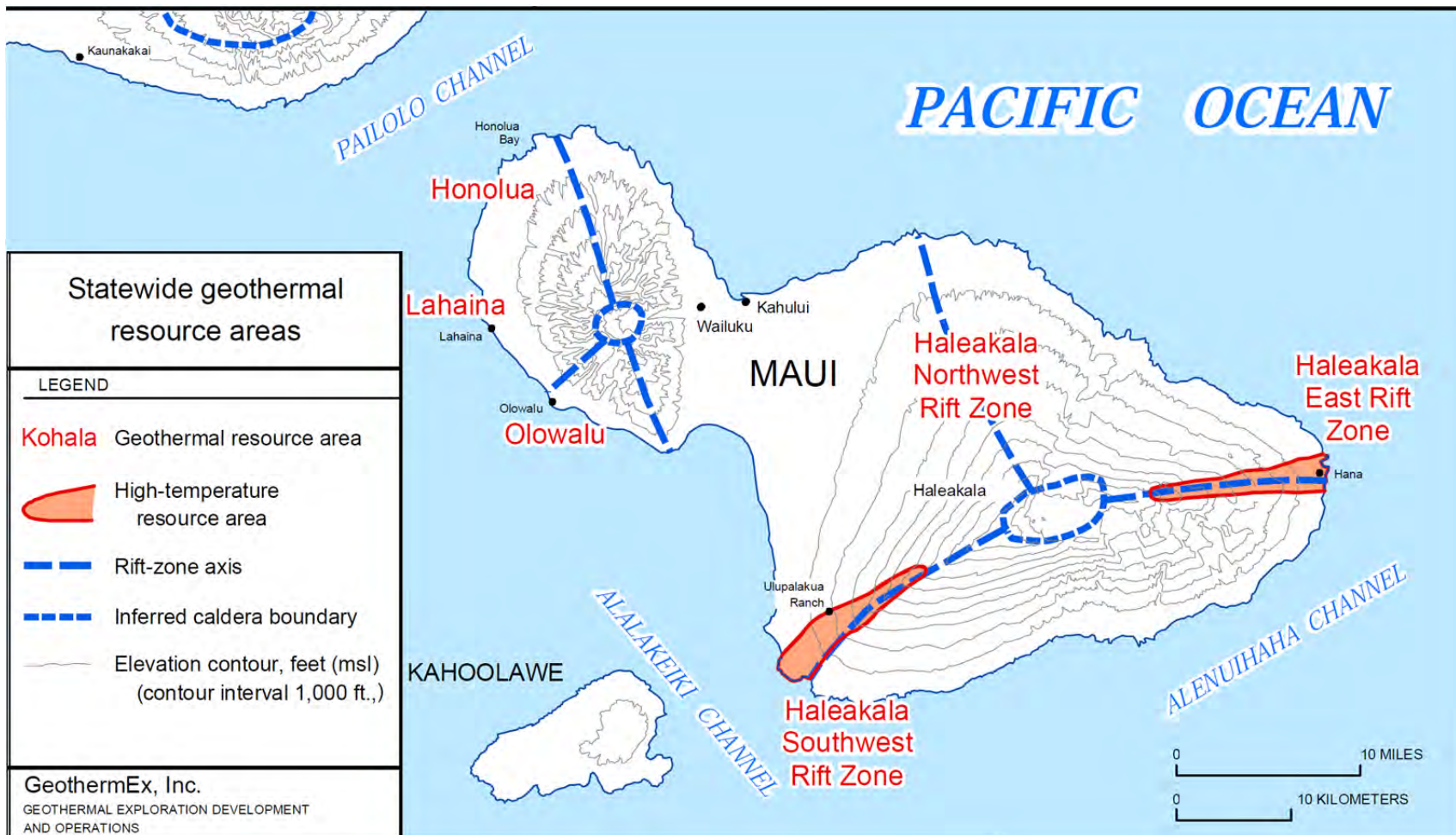


**Figure 1.12:** Location map of the Puna geothermal field and wells drilled as of 2005 (Gill, 2011).

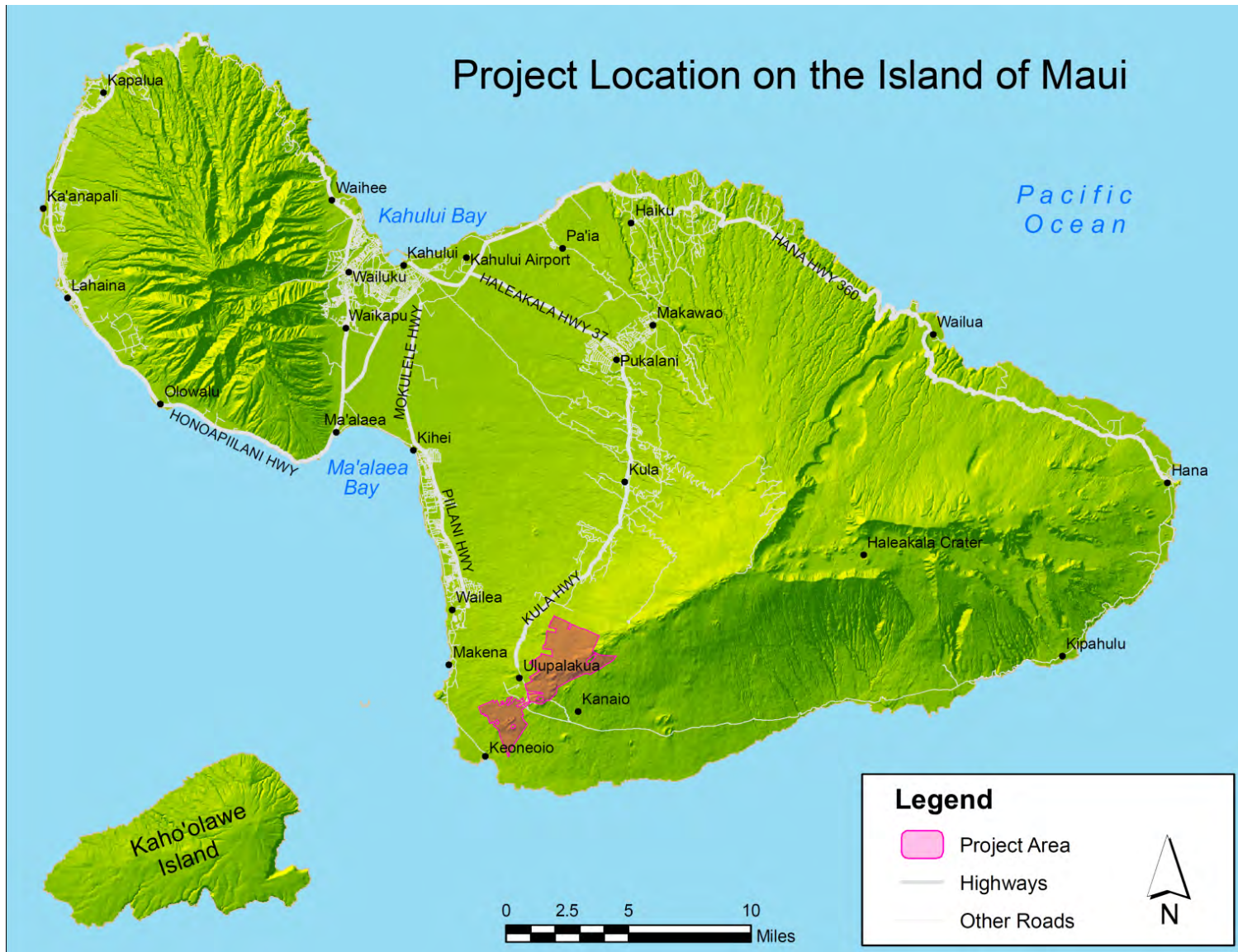




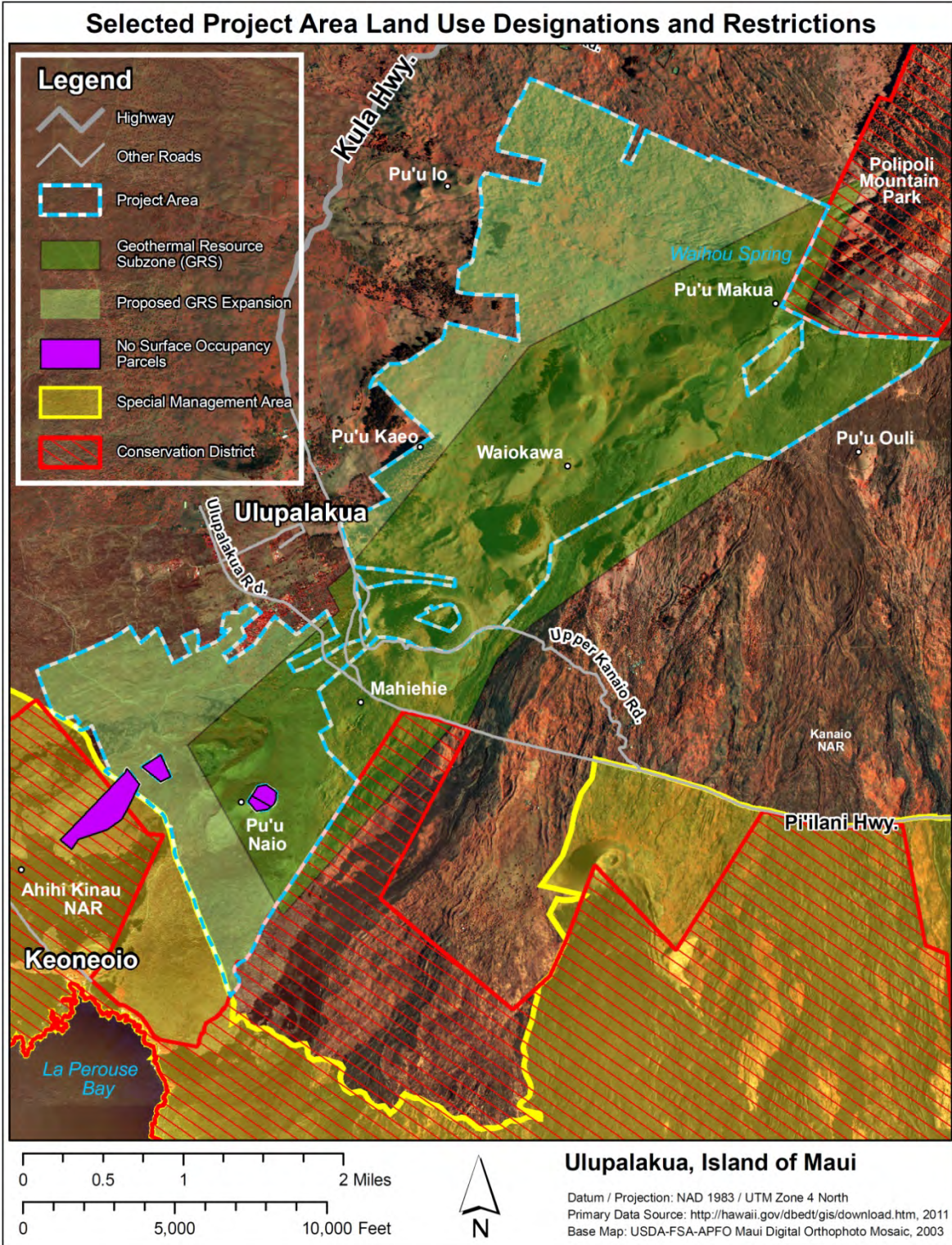
**Figure 1.13:** PGV location setting and wellfield showing location of dacite melt encountered in KS-13 (Teplow *et al.*, 2009).



**Figure 1.14:** Location map of Haleakala Southwest Rift Zone, Maui (GeothermEx, 2000).



**Figure 1.15:** Map showing location of Ulupalakua project area (DLNR, 2012b).



**Figure 1.16:** Land use map of Ulupalakua area (DLNR, 2012b).

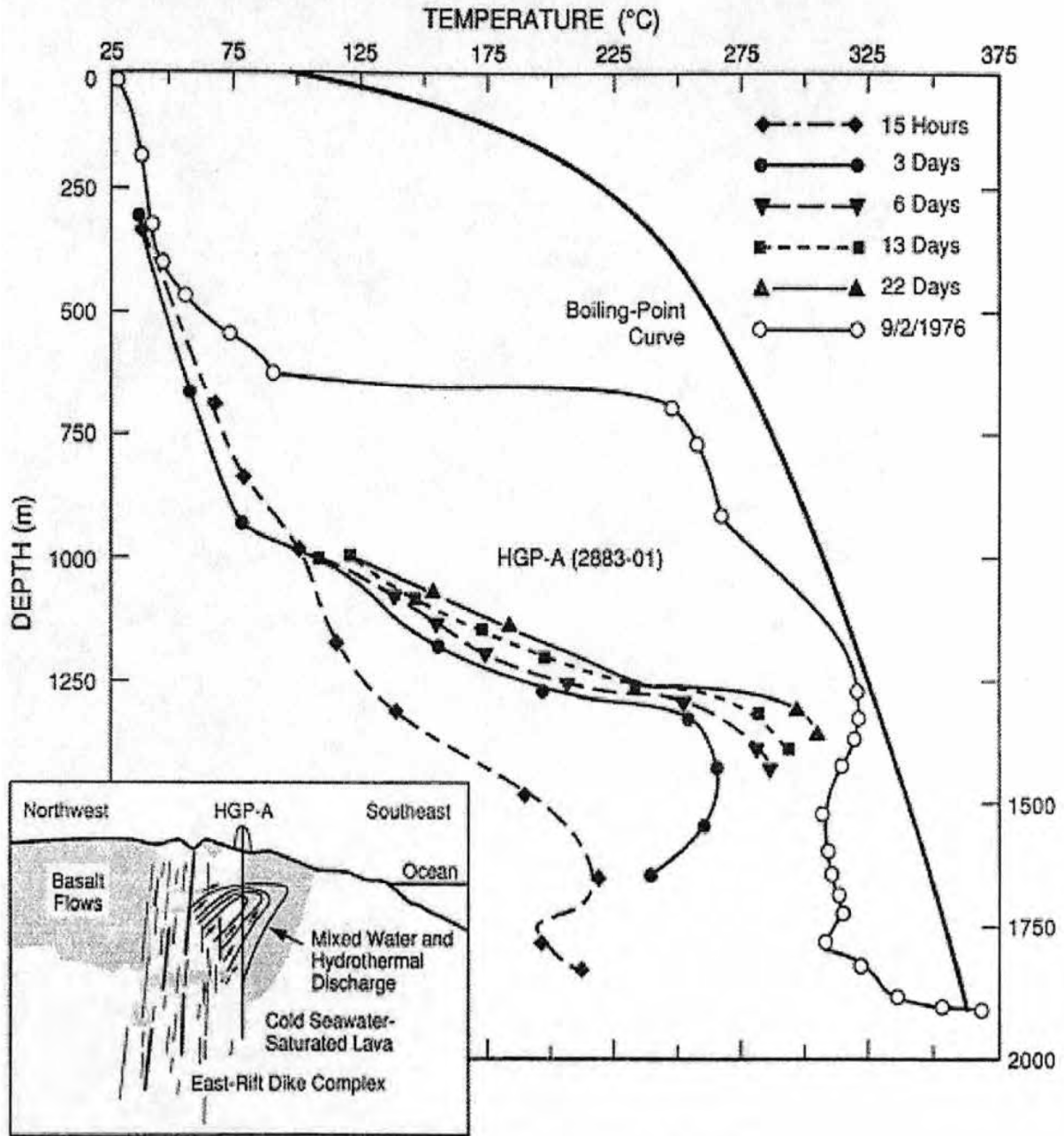
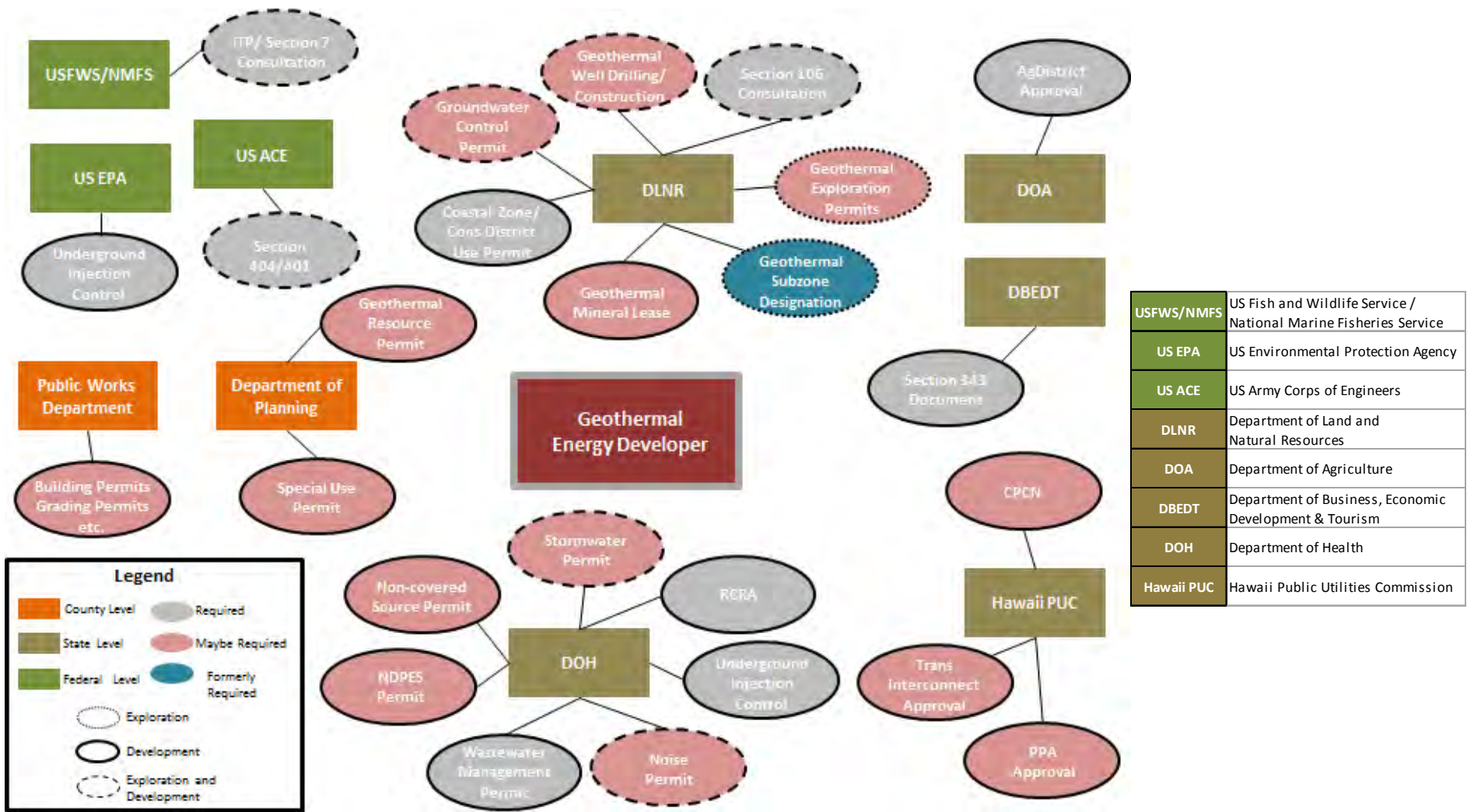


Figure 1. Temperature-Depth profile of research well HGP-A (1976)(Wohletz and Heiken, 1992).

**Figure 1.17:** Downhole temperature profiles for well HGP-A (Kinslow *et al.*, 2012).



**Figure 2.1:** The various agencies involved in the geothermal permitting process in Hawaii.

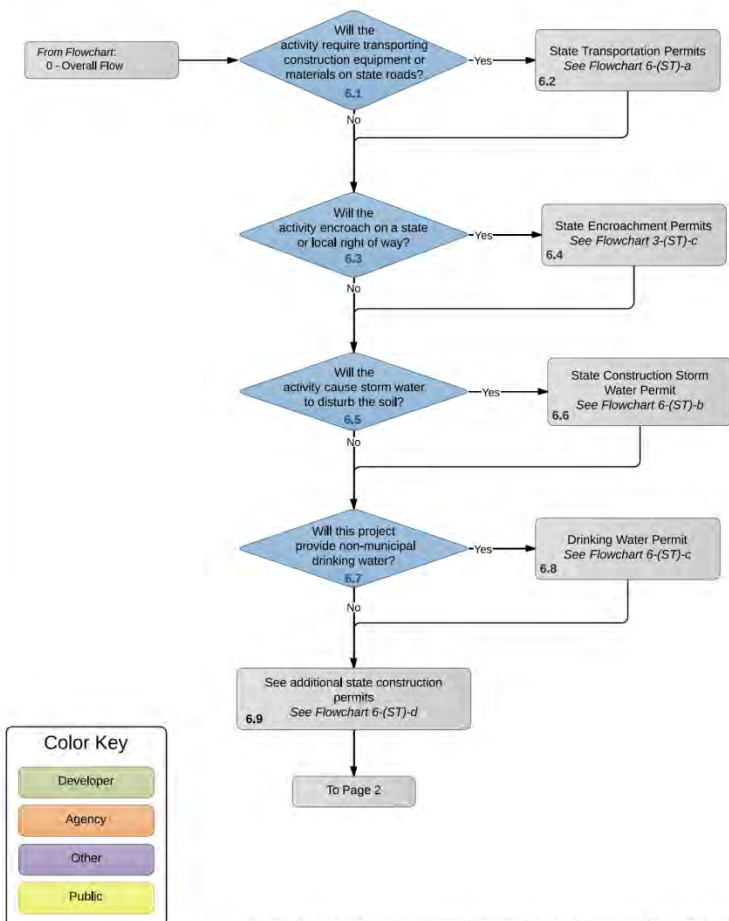


**Figure 2.2:** Land use district boundaries for the State of Hawaii (DBEDT, 2014c).

**Flowchart 6:  
Construction Permits Overview**

Version: 29 October 2012

Page 1 of 2  
Approximate Time Frame:  
XX Days



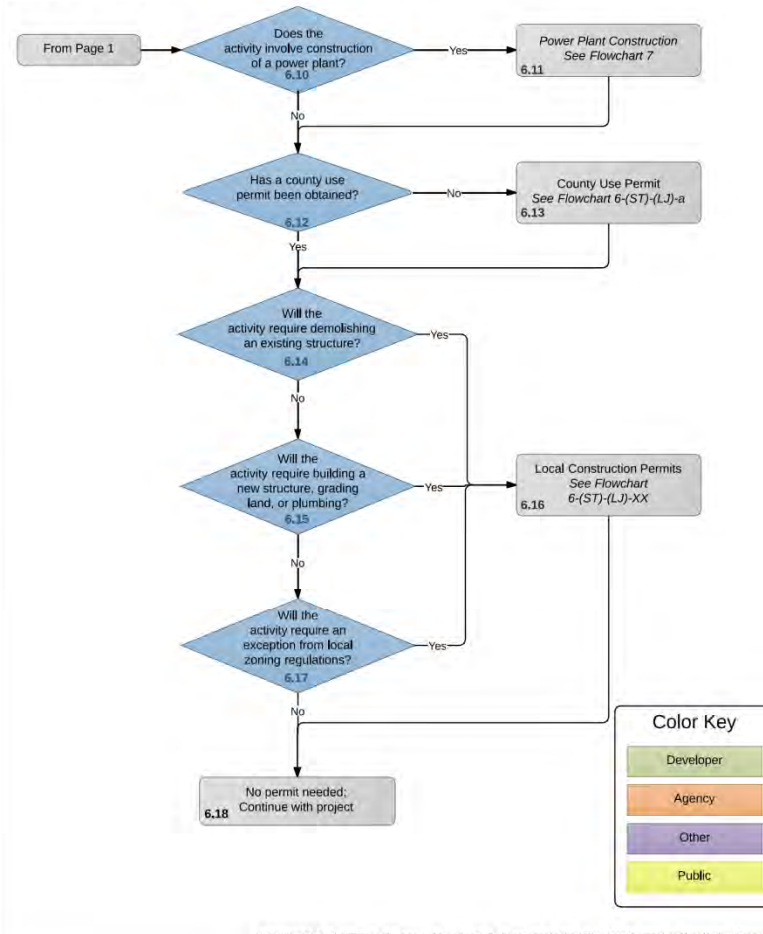
Developed by the National Renewable Energy Laboratory for the DOE Geothermal Technologies Program



**Flowchart 6 (continued):  
Construction Permits Overview**

Version: 26 September 2012

Page 2 of 2



Developed by the National Renewable Energy Laboratory for the DOE Geothermal Technologies Program



**Figure 2.3:** Construction permit flowchart from Geothermal Regulatory Roadmap website (DOE, 2014a).

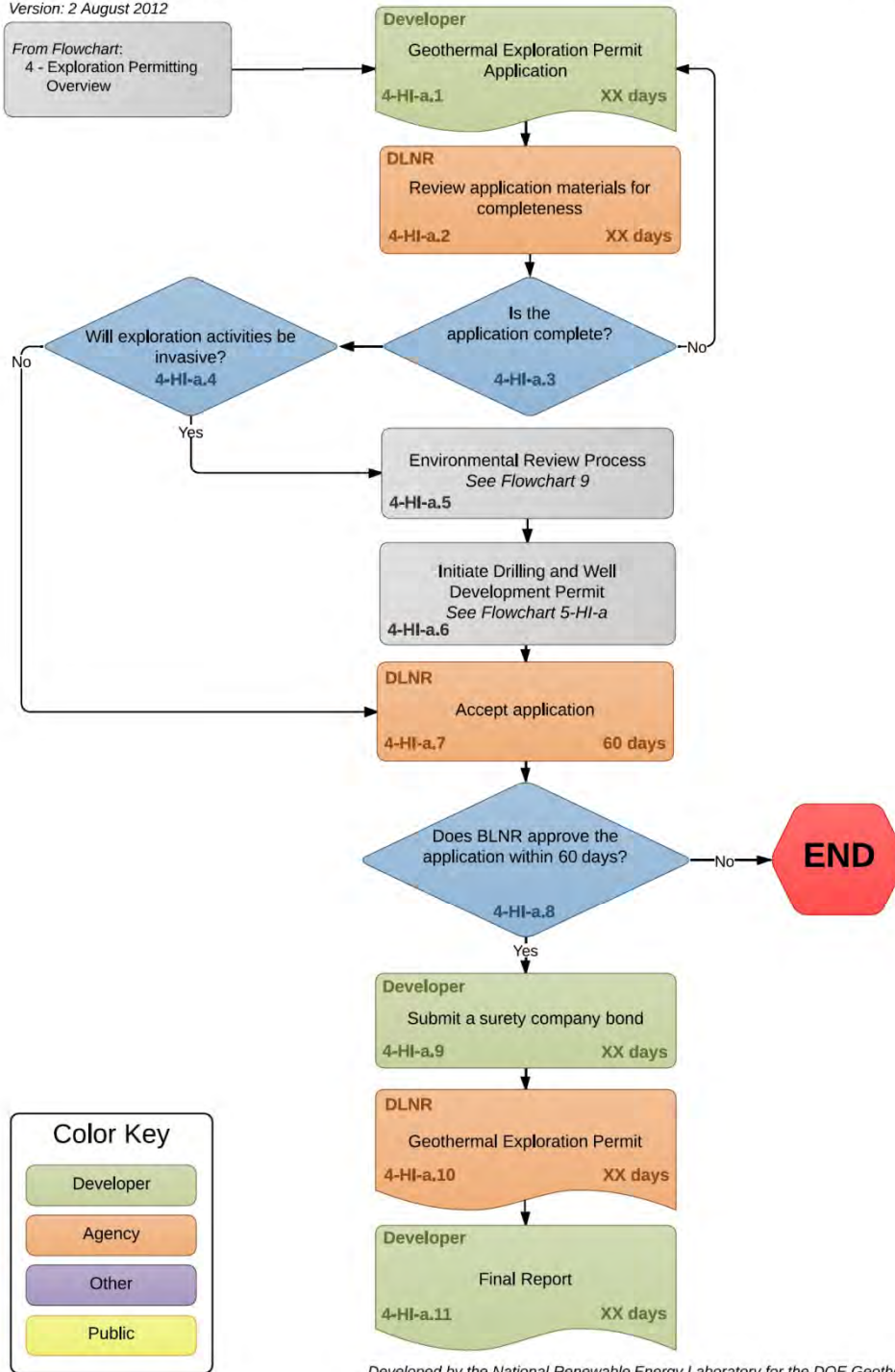


### Flowchart 4-HI-a: Exploration Permit

Version: 2 August 2012

From Flowchart:  
4 - Exploration Permitting  
Overview

Approximate Time Frame:  
XX Days



**Figure 2.4:** Example of flow chart from Geothermal Regulatory Roadmap website (DOE, 2014a).



**Figure 2.5:** Aerial view of vegetation screen at Mammoth Pacific geothermal power plant (USDOI, 2014b).



38 MW Puna Geothermal Power Plant, Hawaii, U.S. (1992, 2004, 2011)

**Figure 2.6:** Air-cooled binary geothermal power plant at Puna (Photo courtesy of Ormat Technologies, Inc.).

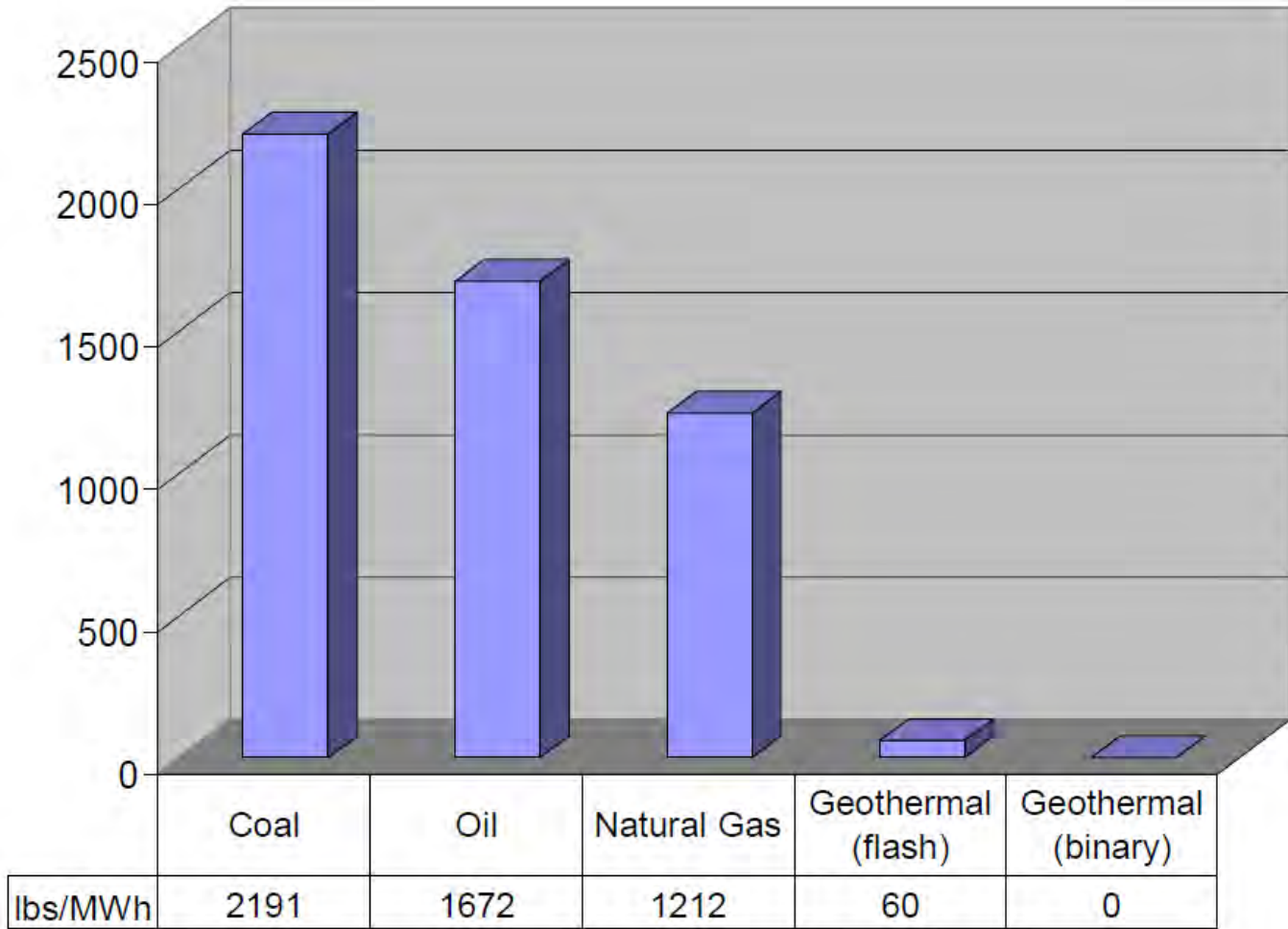
Table 1. Maximum permissible sounds levels in dBA.

Zoning Districts	Daytime (7 a.m. to 10 p.m.)	Nighttime (10 p.m. to 7 a.m.)
Class A	55	45
Class B	60	50
Class C	70	70

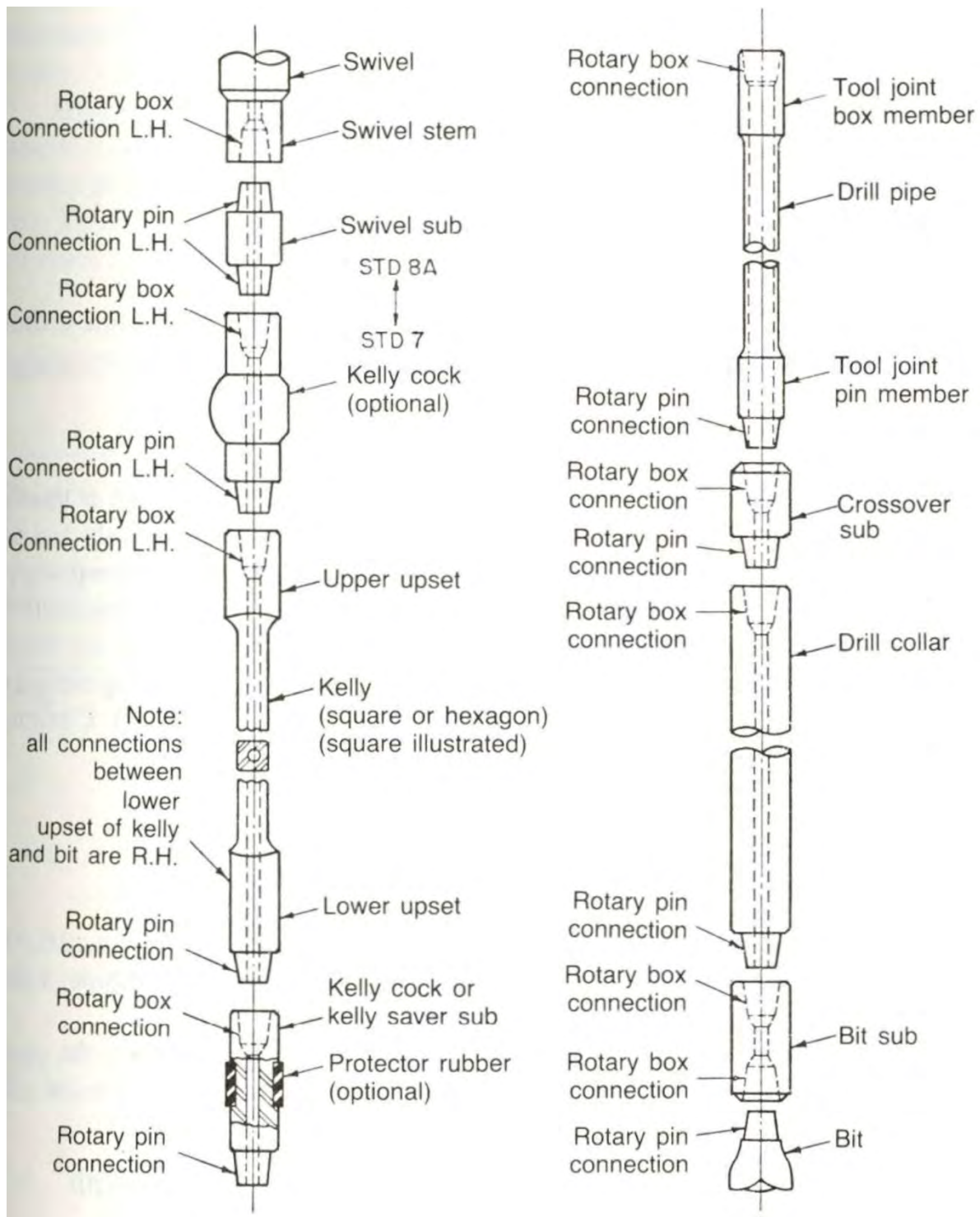
Figure 2.7: Maximum permissible sound Levels from HAR Chapter 11-46 (PICHTR, 2013).



**Figure 2.8:** Puna air quality monitoring station locations (DOH, 2013).



**Figure 2.9:** Relative output of CO<sub>2</sub>, expressed in pounds (lbs) per unit of energy (megawatt-hours, MWh) (GEA, 2007).

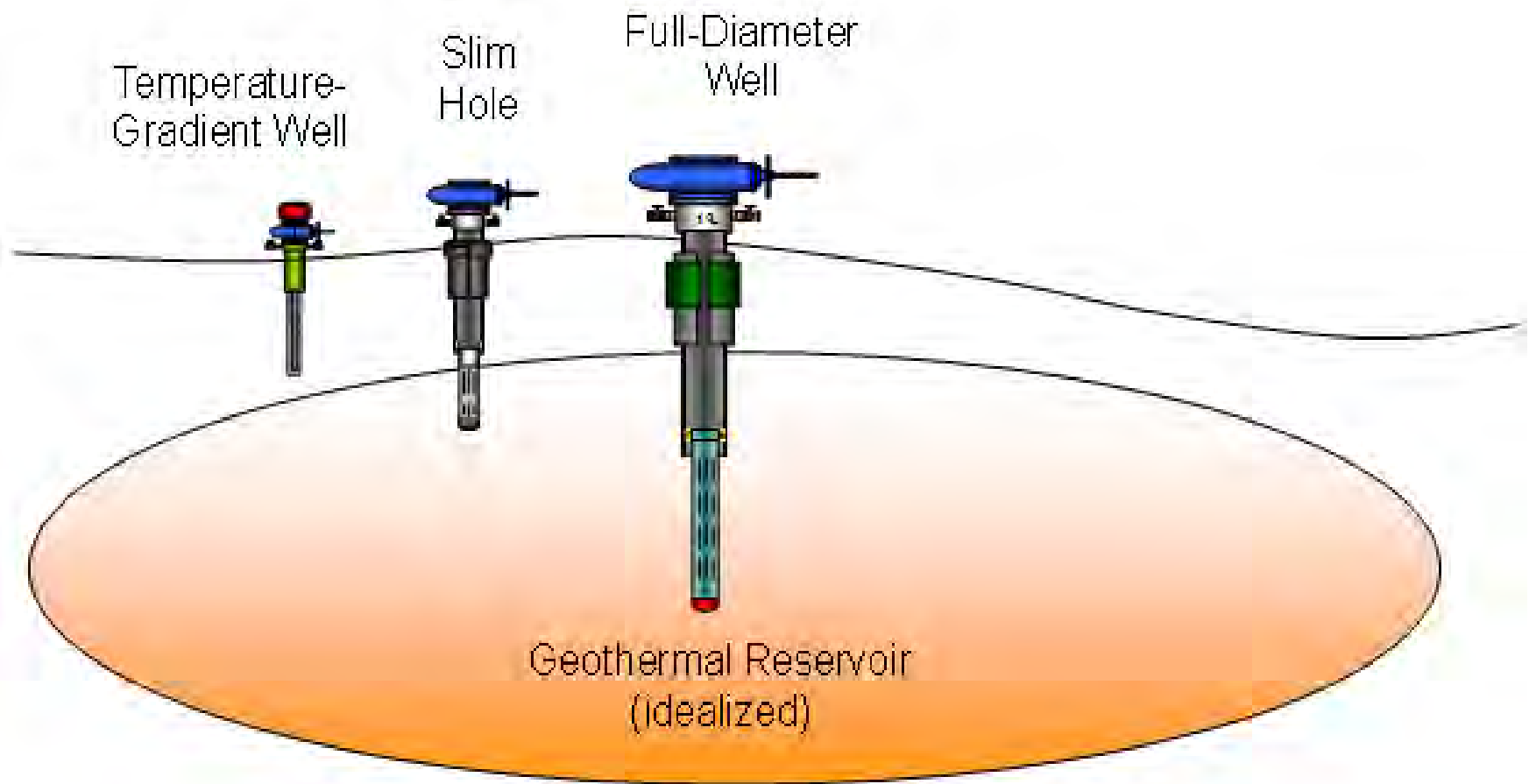


**Figure 3.1:** Bottomhole assembly (BHA) diagram (Ngugi, 2008).



**Figure 3.2:** Tri-cone roller bits (left) and polycrystalline diamond compact (PDC) bits (right) (Ngugi, 2008).

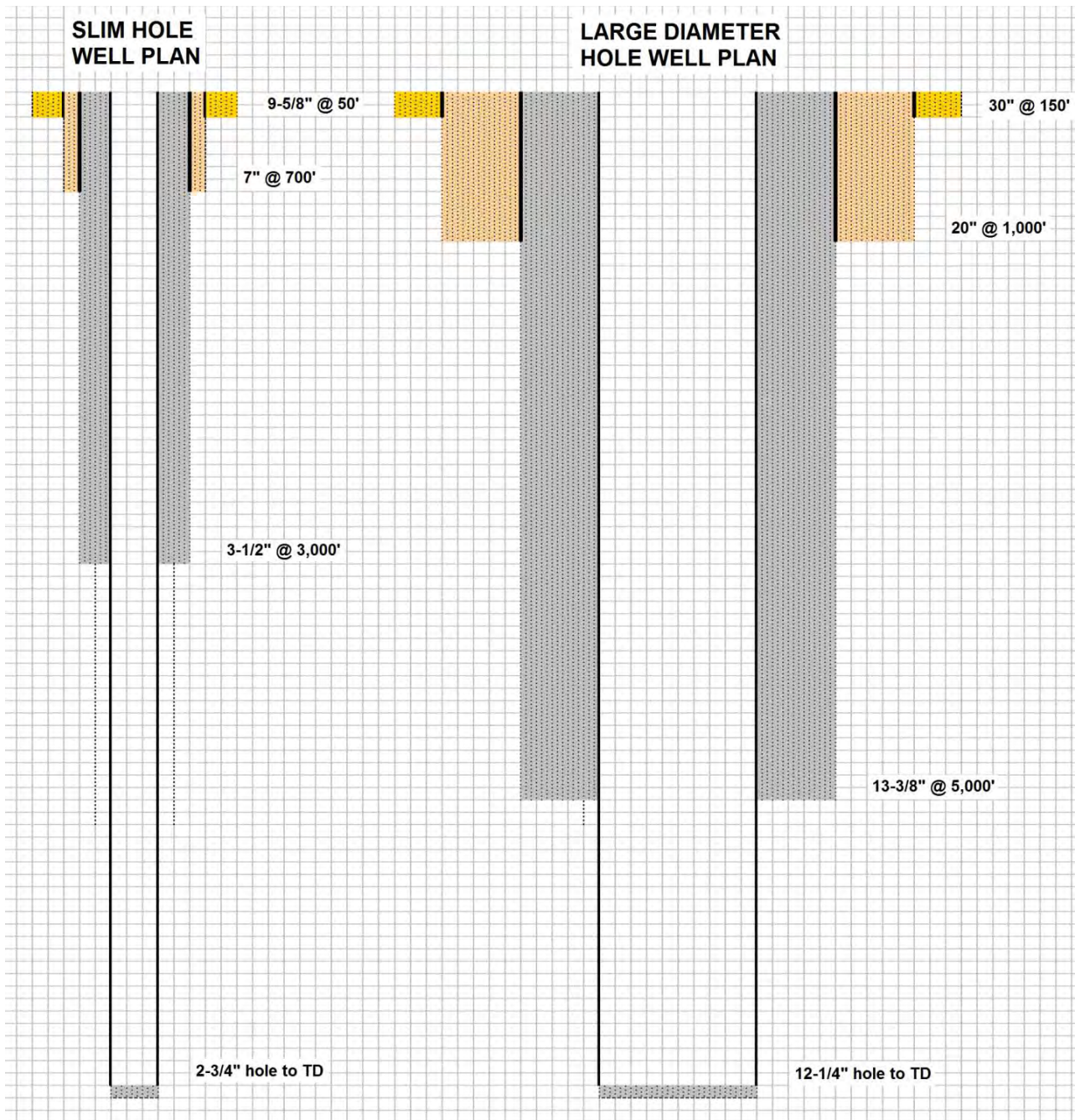




**Figure 3.3:** Comparison of relative diameter and depth of exploration wells.



**Figure 3.4:** Drilling of a temperature gradient well.



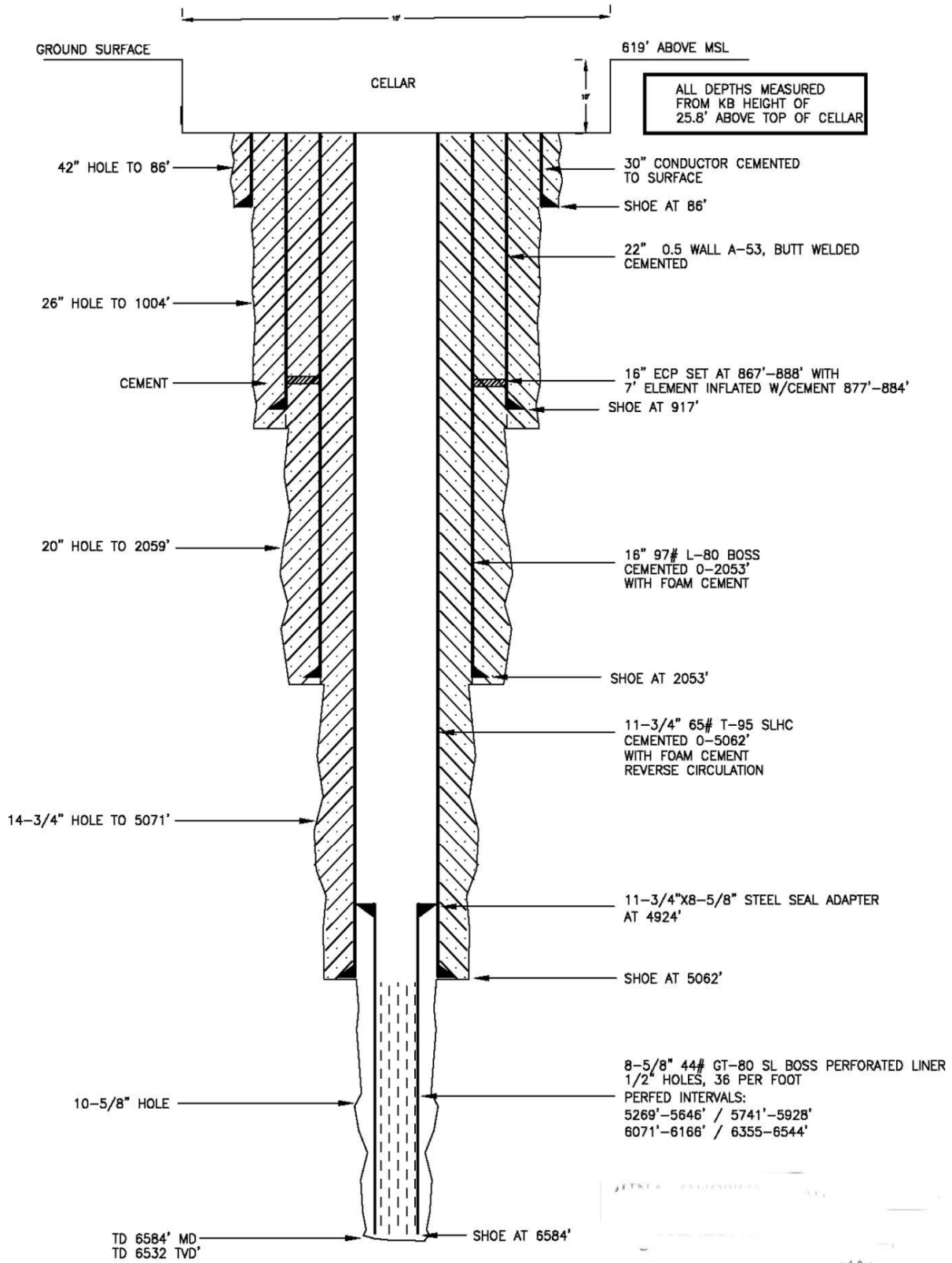
**Figure 3.5:** Comparison of slim hole and large diameter hole designs, (after Tuttle *et al.*, 2010).



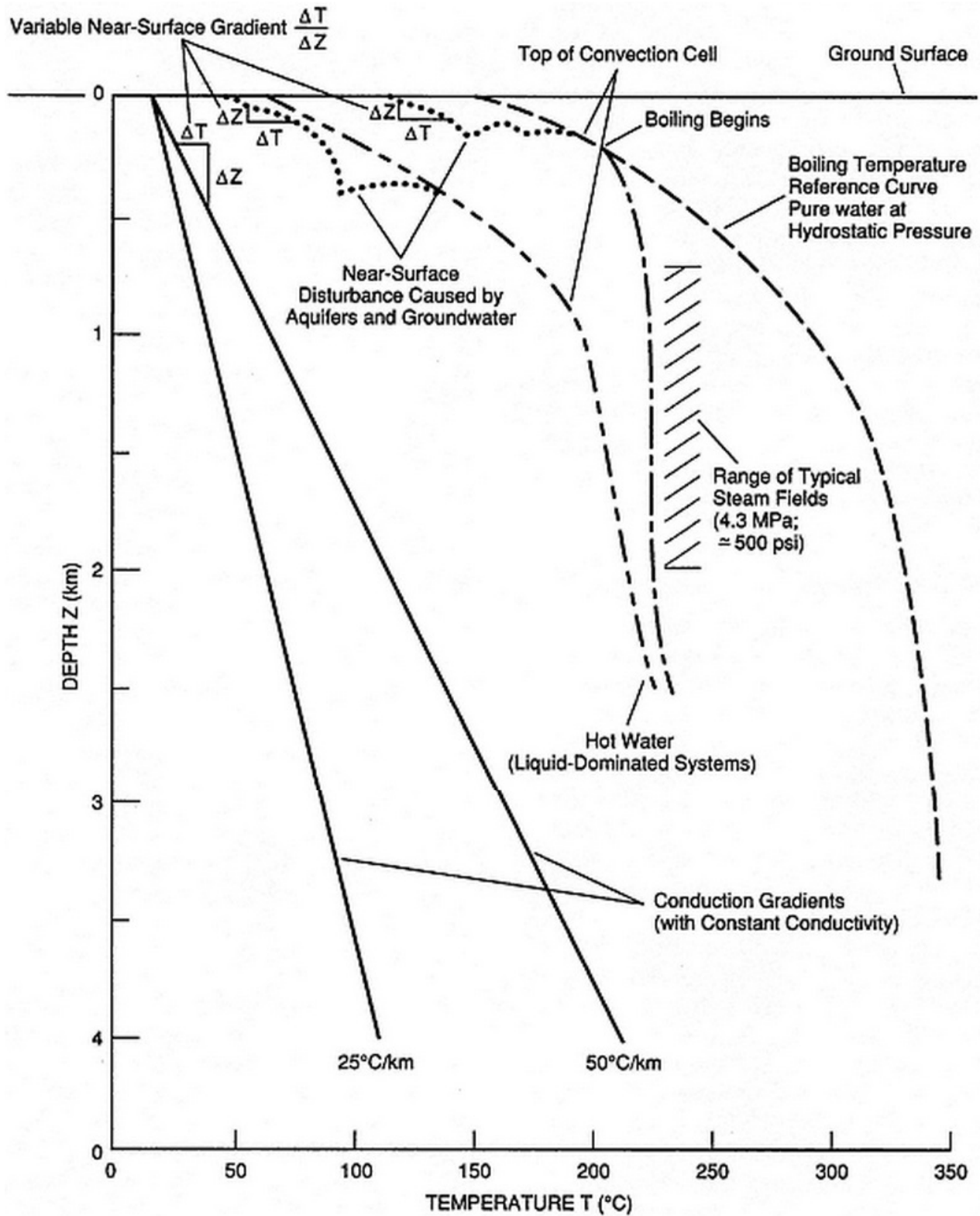
**Figure 3.6:** Drilling of a slim well.



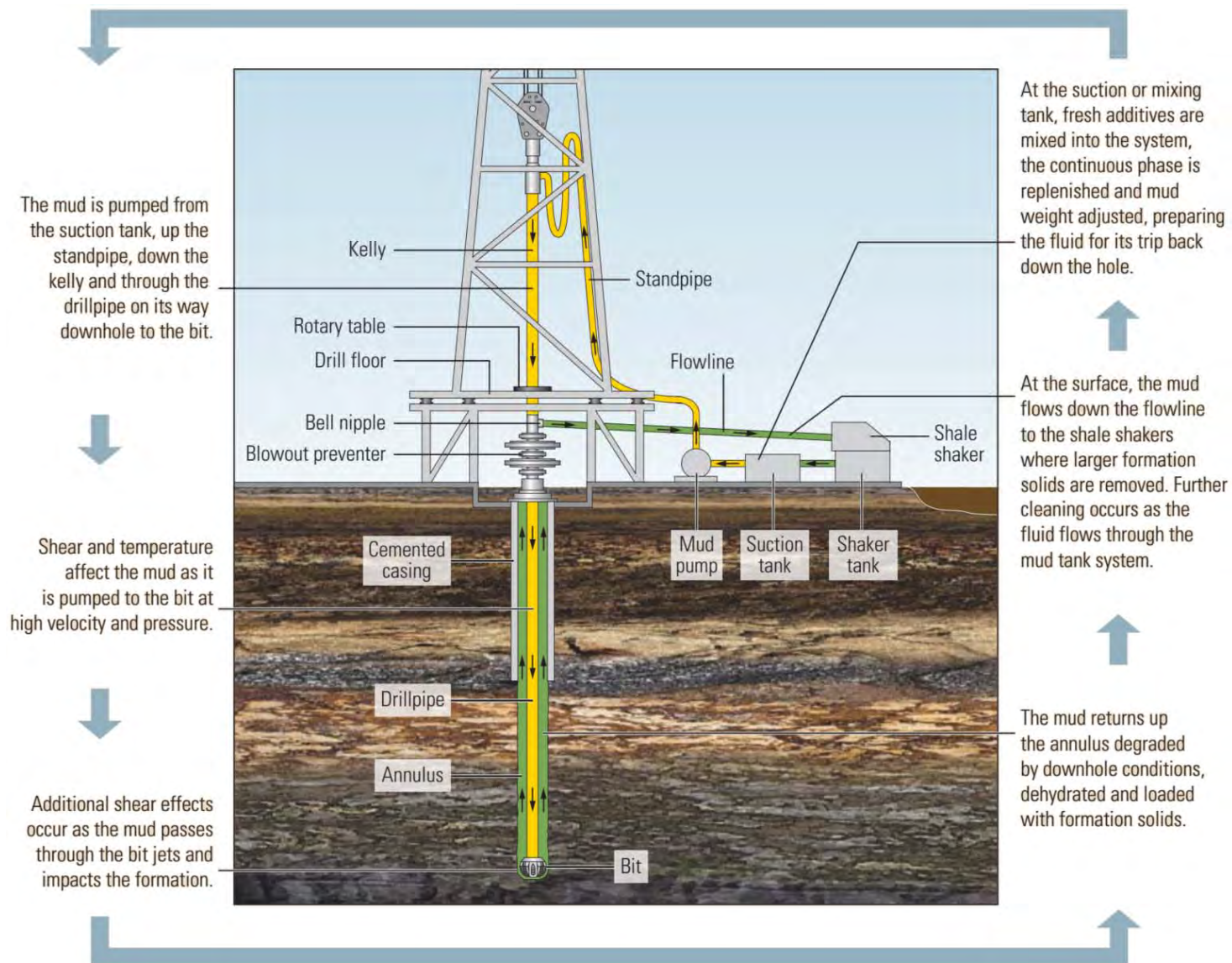
**Figure 3.7:** Drilling of a full diameter well.



**Figure 3.8:** Completion diagram of full diameter well (Spielman, 2006).



**Figure 3.9:** Temperature-depth diagram depicting several thermal gradients and their corresponding influence on geothermal gradients at the earth's surface (Wohletz and Heiken, 1992).



**Figure 3.10:** Drilling fluid life cycle (Williamson, 2013).



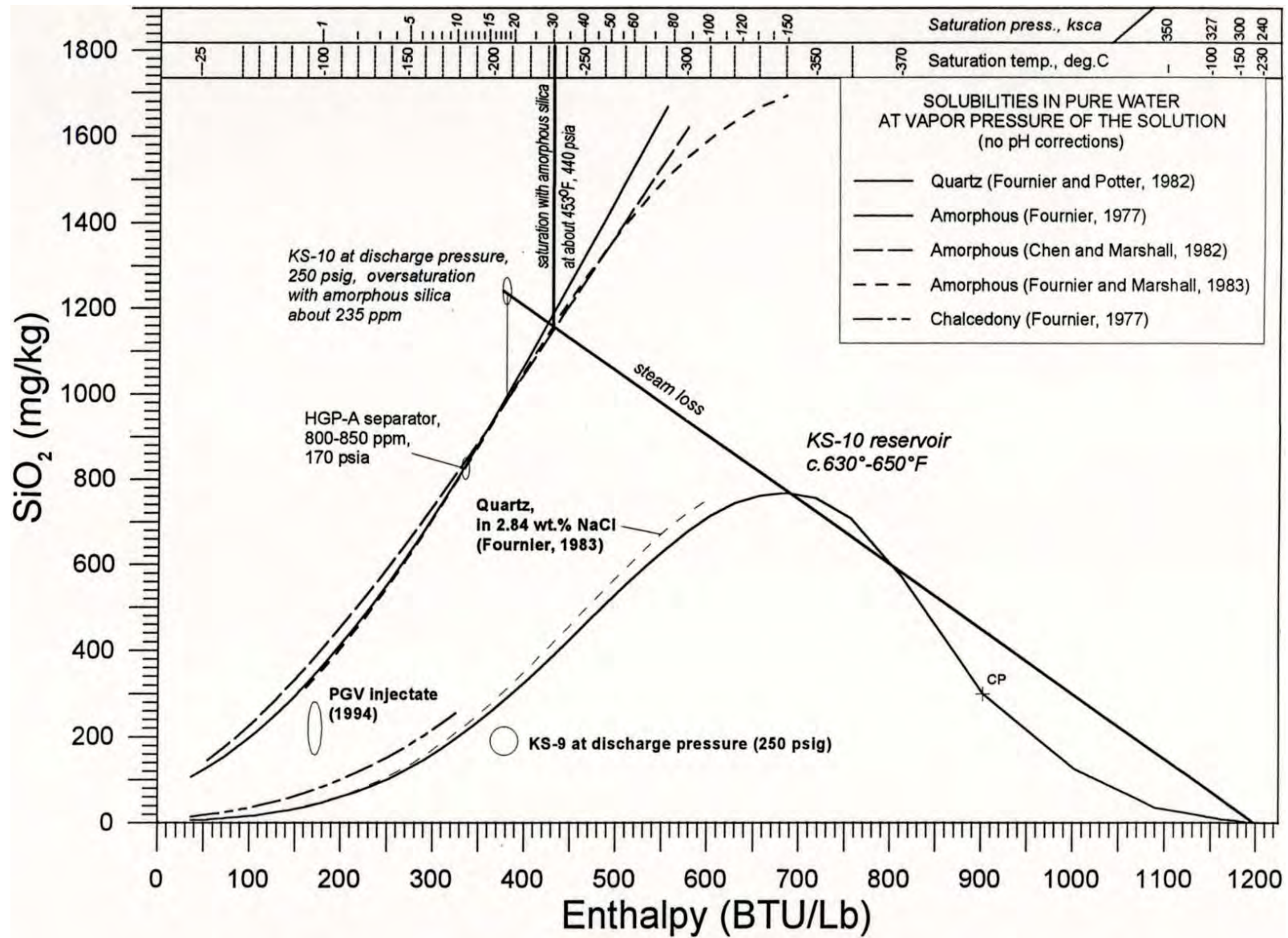


Figure 3.11: Graph showing PGV process conditions versus solubility of silica (GeothermEx, 1994).

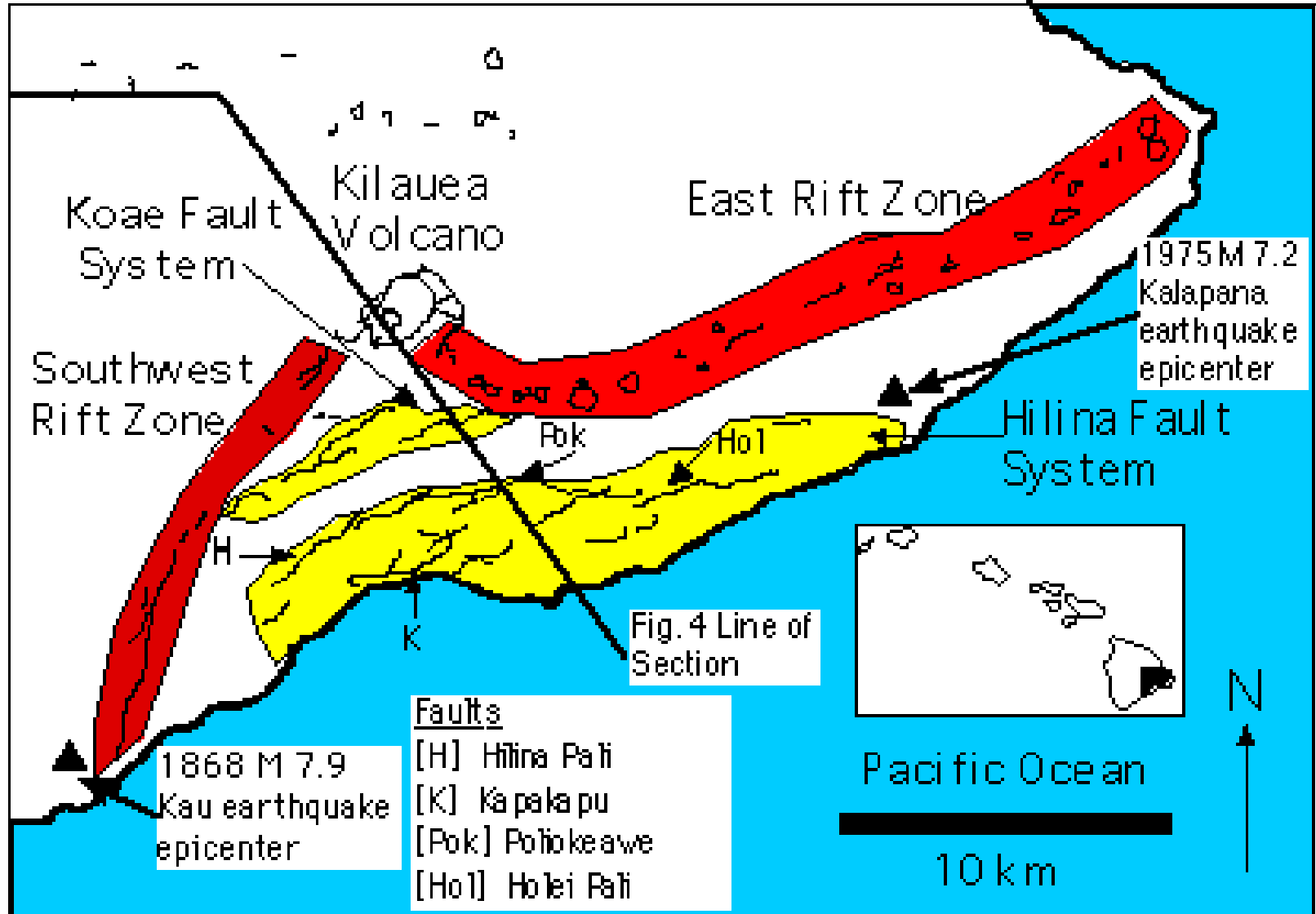
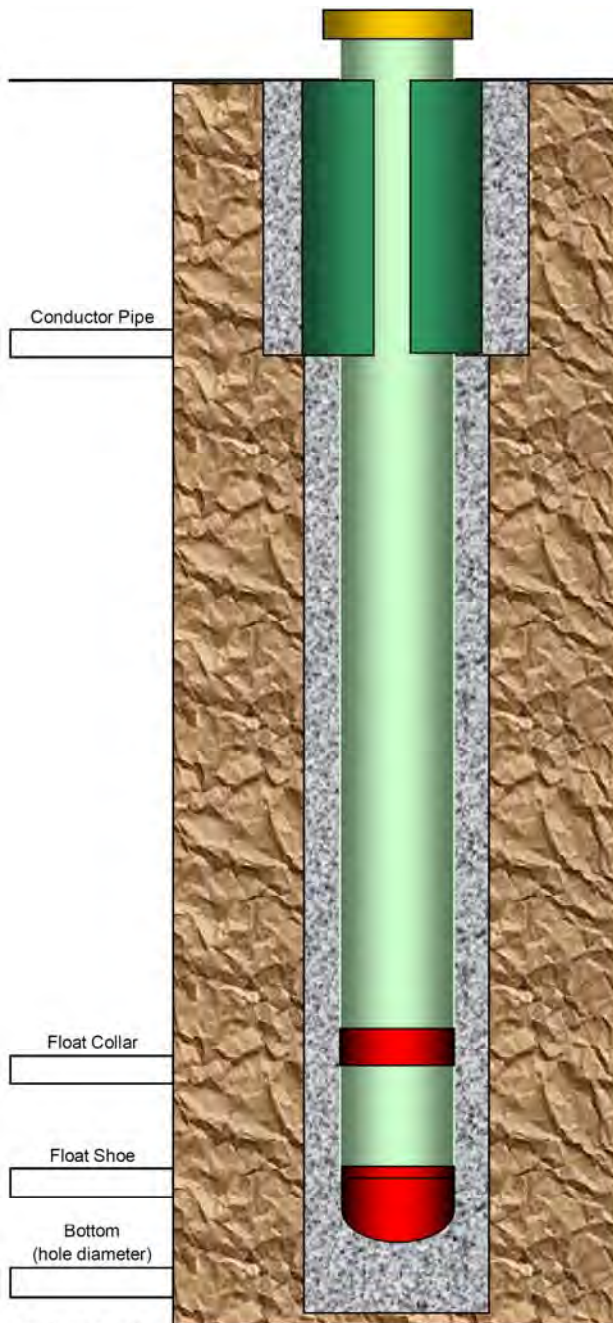


Figure 3.12: Location map of Hilina fault system south of rift zones on Hawaii (Cannon, 1999).



**Casing Details :**

Tack-weld ## joints. Run centralizers as recommended by cement engineer

**Cement Details :**

Pump (volume) of water ahead, followed by (volume) of pre-flush.

Do not exceed (pressure rating) while cementing or displacing.

Pressure-test all lines to (pressure rating) before starting cement operation

Use cement retarder, friction reducer, defoamer and fluid loss control additives as recommended by cementing operator.

**Cement Worksheet**

**Initial Parameters**

	Meters of Tail Cement
	% Excess Lead Cement in Open Hole
	% Excess Lead Cement in Cased Hole
	% Excess Tail Cement in Open Hole
	Drill Pipe Capacity* (m <sup>3</sup> /m)
	Casing Capacity (m <sup>3</sup> /m)
	Volume Between Casings (m <sup>3</sup> /m)
	Volume Bet.Csg & Open Hole (m <sup>3</sup> /m)
	Lead Cement Yield (ton/m <sup>3</sup> )
	Tail Cement Yield (ton/m <sup>3</sup> )
	Lead Water L/Sk
	Tail Water L/Sk
	Lead Cement Weight
	Tail Cement Weight

**Lead Slurry Calculations (m<sup>3</sup>)**

Calculated Lead Slurry in Open Hole	
Calculated Lead Slurry Bet. Csngs.	
Excess Lead Slurry in Open Hole	
Excess Lead Slurry in Cased Hole	

**Tail Slurry Calculations (m<sup>3</sup>)**

Calculated Tail Slurry	
Excess Tail Slurry	
Slurry in Float Shoe/Collar	

**Calculated Totals (m<sup>3</sup>)**

Total Lead Slurry	
Total Tail Slurry	
Total Slurry for the Job	

**Displacement Volumes (m<sup>3</sup>)**

Wiper Plug Method	
Stab-in Method	

**Cement Weight (ton) (m<sup>3</sup>)**

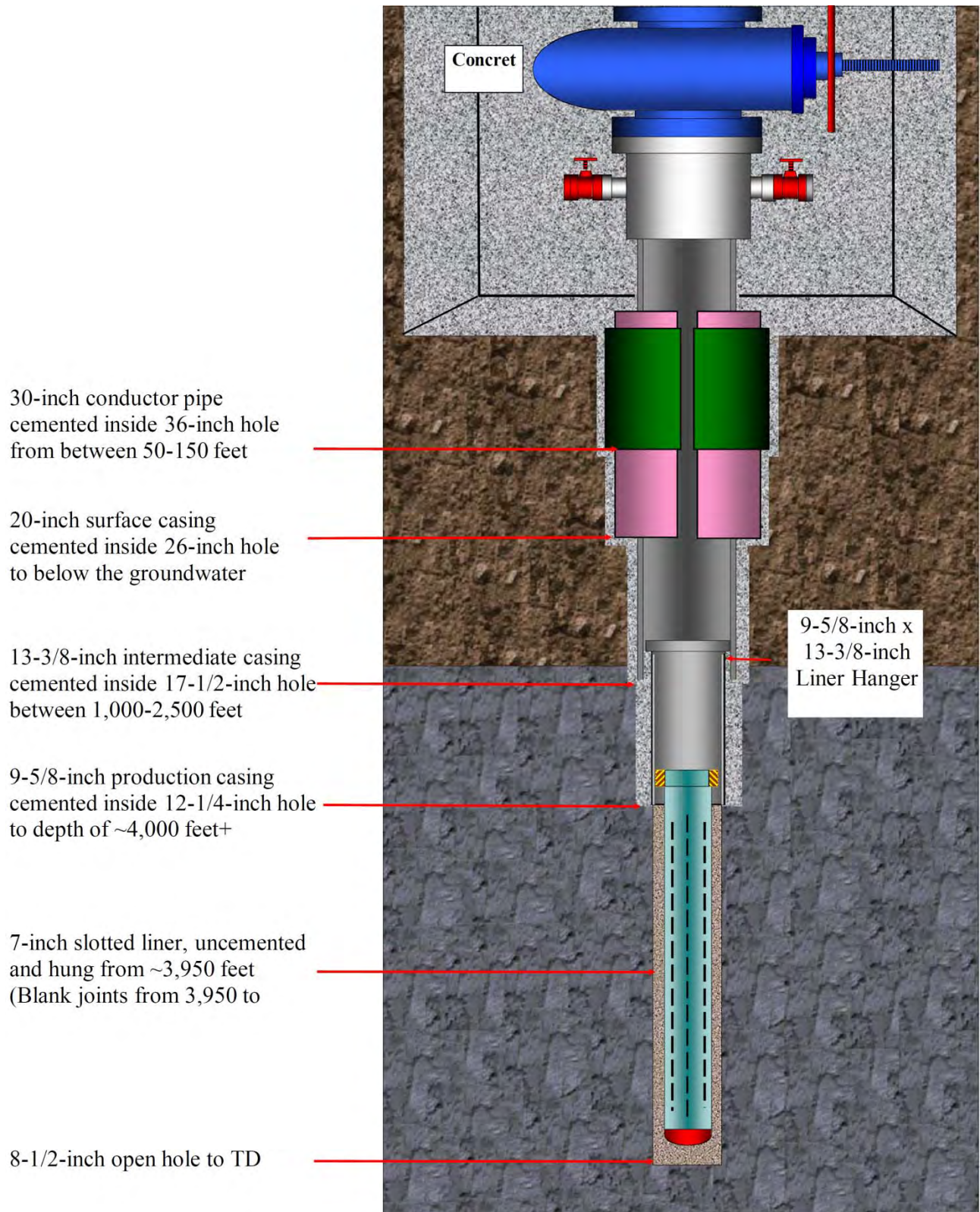
Lead Cement		
Tail Cement		

Total Cement

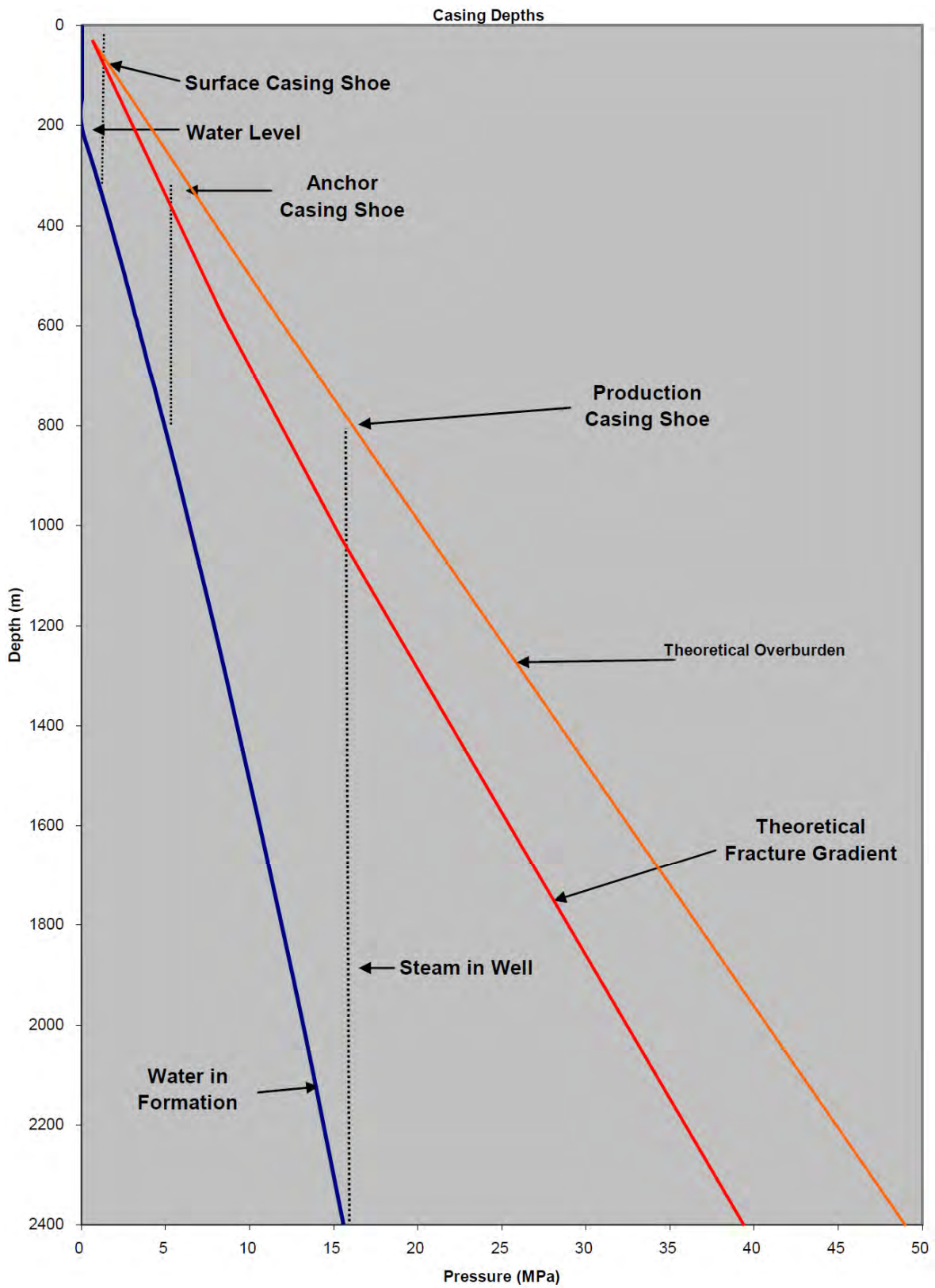
**Slurry Water (bbl) (m<sup>3</sup>)**

Lead Cement		
Tail Cement		
Total Water		

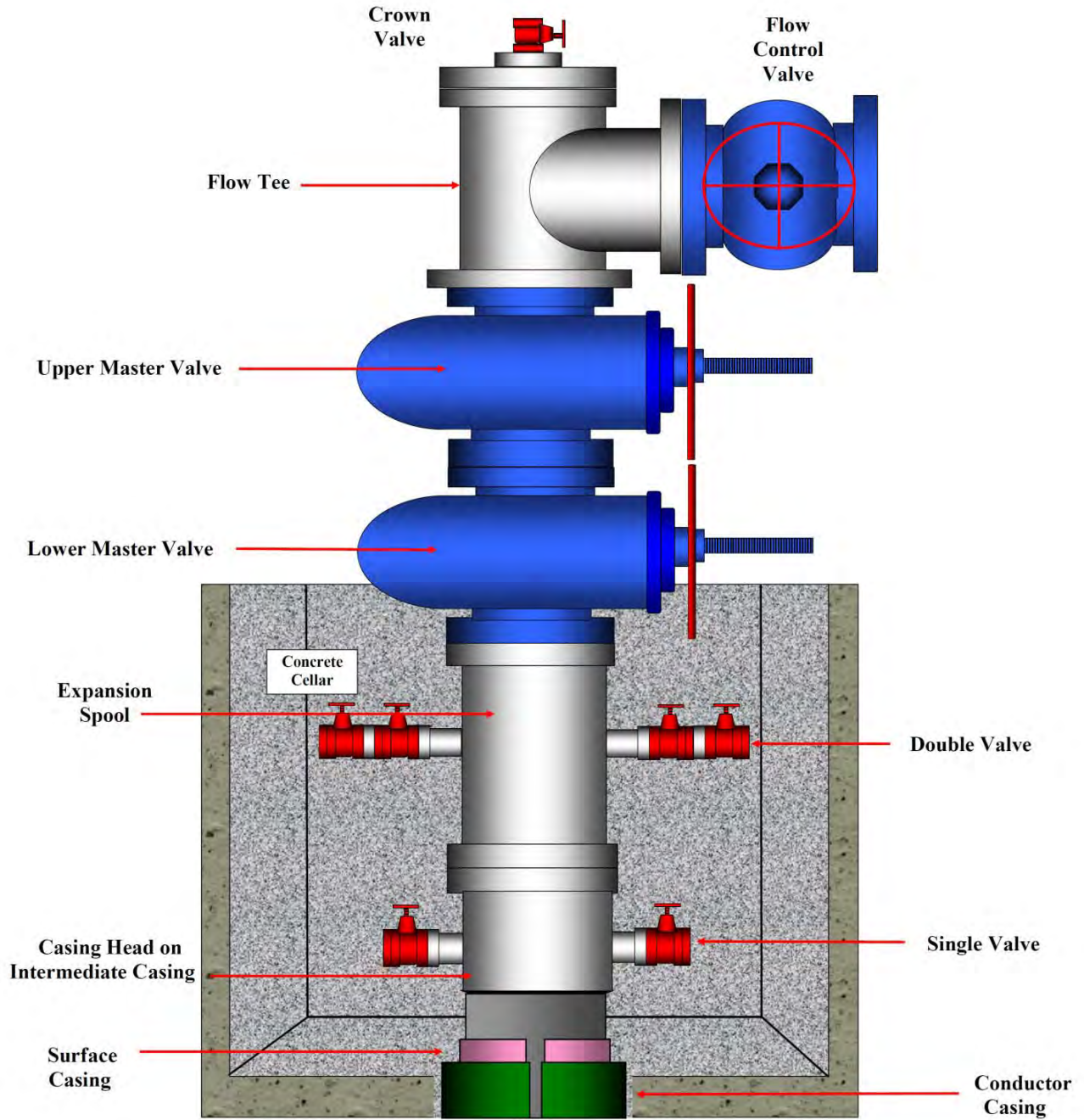
**Figure 4.1:** Cementing calculations worksheet for casing (GeothermEx).



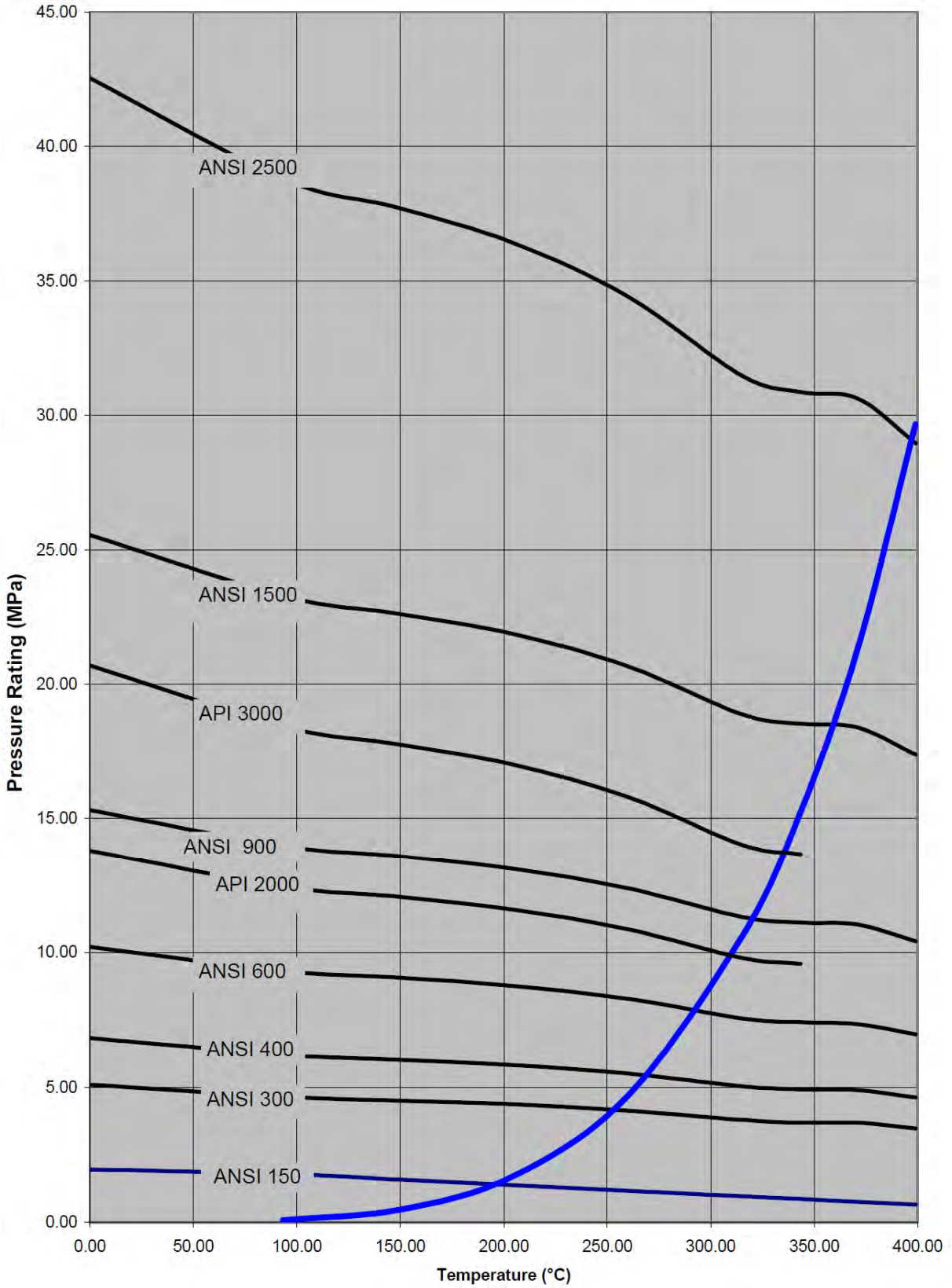
**Figure 4.2:** Typical geothermal casing profile (GeothermEx).



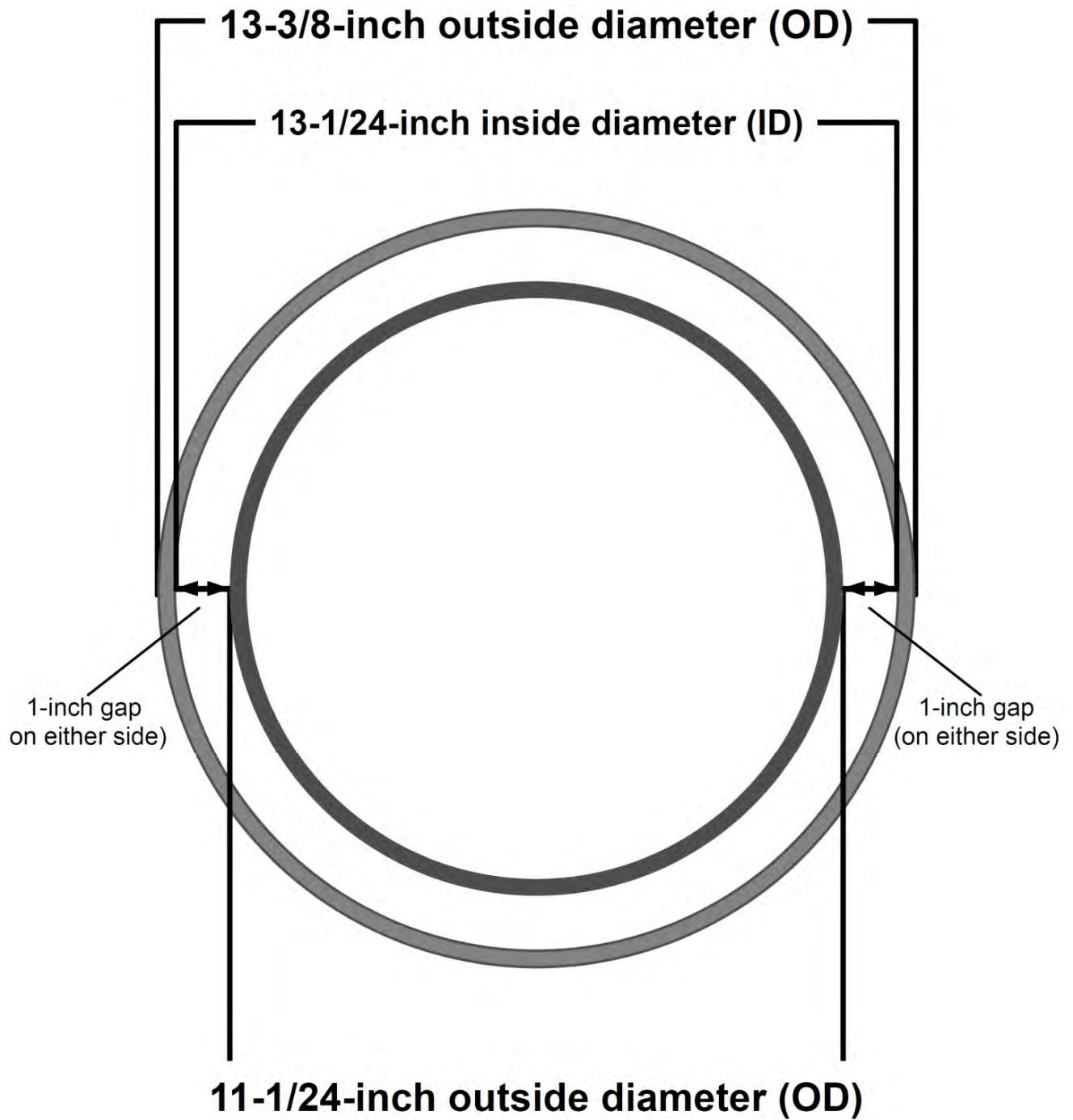
**Figure 4.3:** Theoretical casing setting depths (Hole, 2010b).



**Figure 4.4:** Typical wellhead configuration for geothermal well.

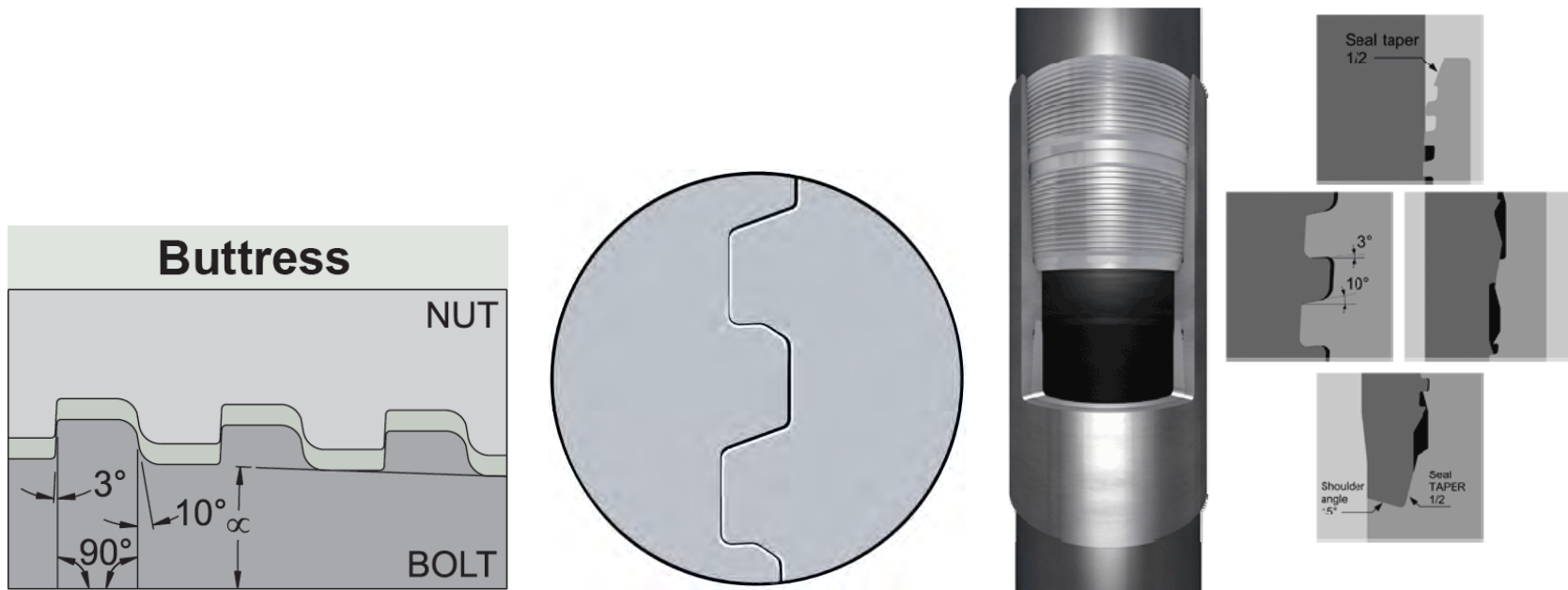


**Figure 4.5:** Working wellhead pressures de-rated for temperature increases (Hole, 2008b).

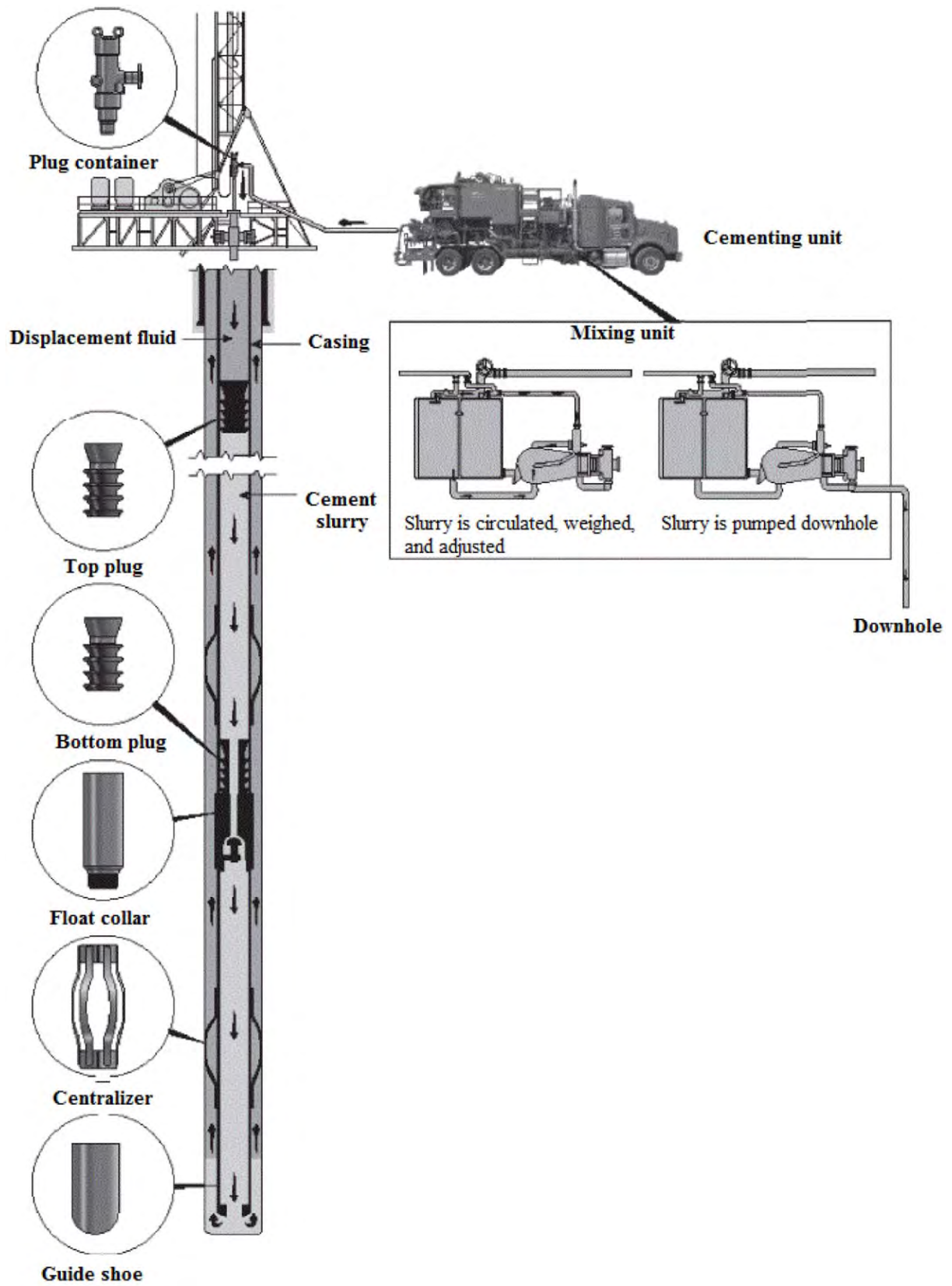


**Figure 4.6:** Relative inner and outer casing diameters for satisfactory cementing job.

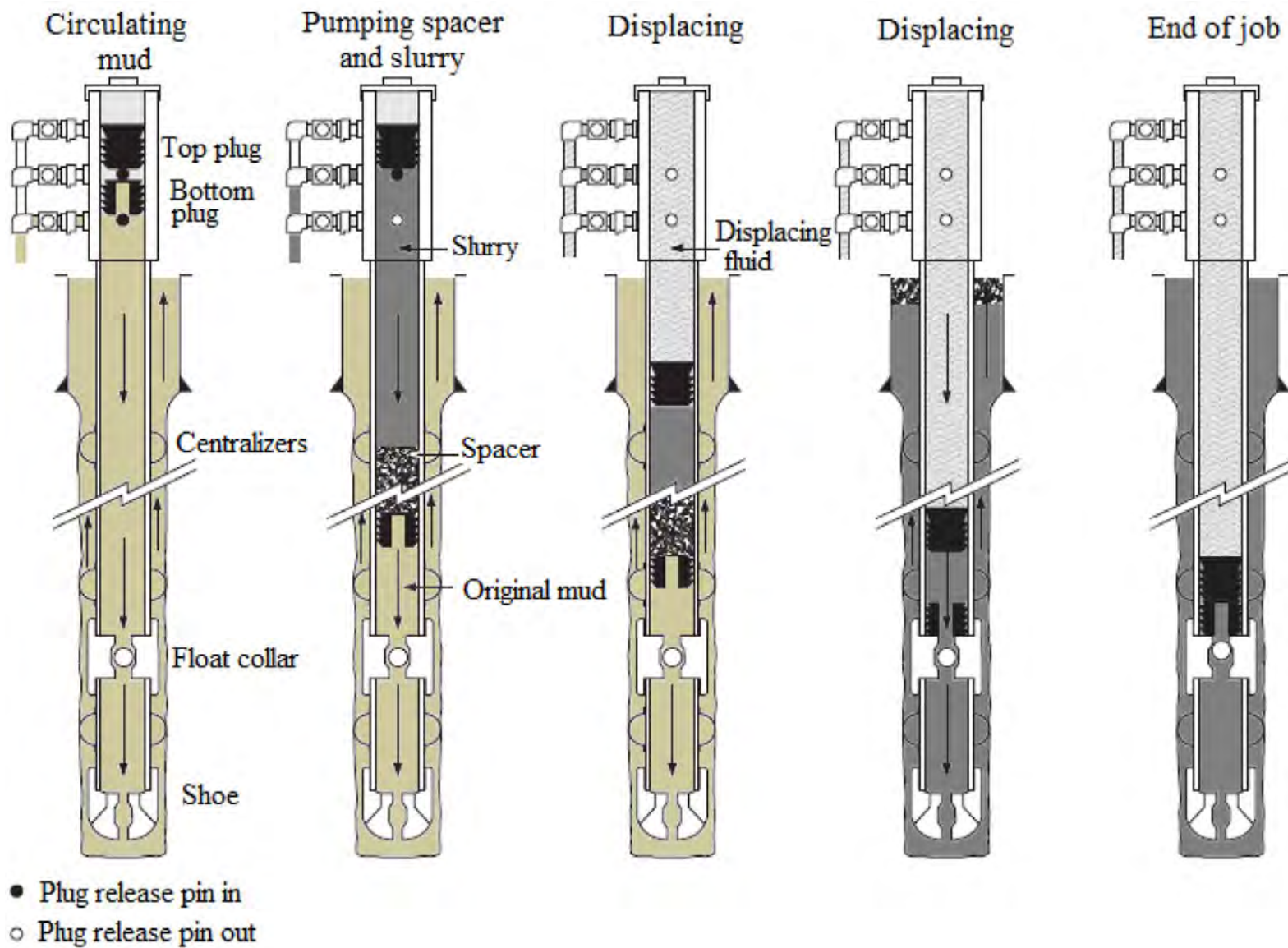




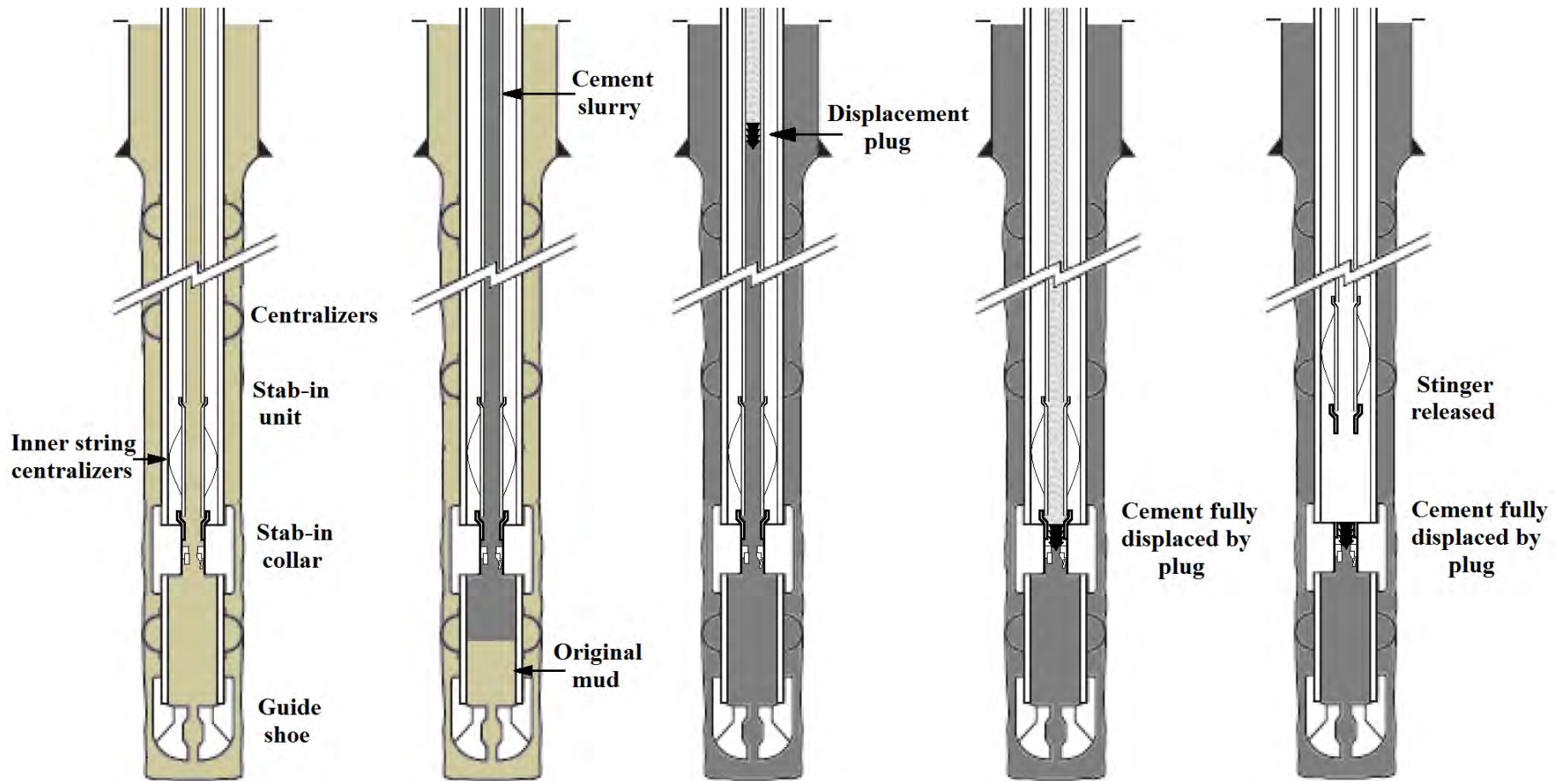
**Figure 4.7:** LEFT: Buttress threads are square-cut and create a hydraulic seal through the interference fit of the mating threads (Dorian, 2012). CENTER: Seal-Lock threads are geometrically interlocking to provide the best thread seal (Huntington, 2014). RIGHT: VAM hook thread design is designed to minimize potential for joint failure during tensioning (VAM, 2014).



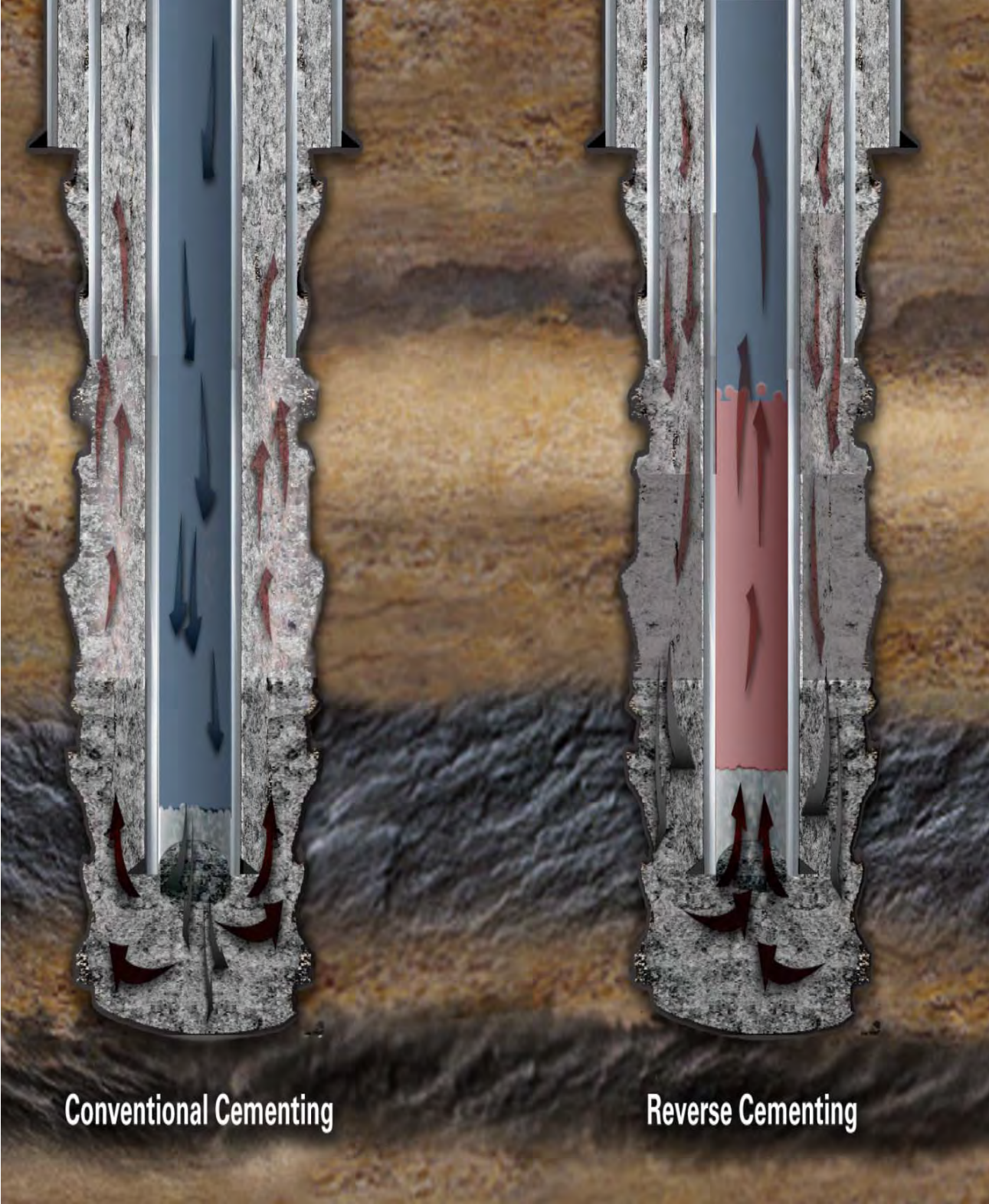
**Figure 4.8:** Typical geothermal well cementing process (Bett, 2010).



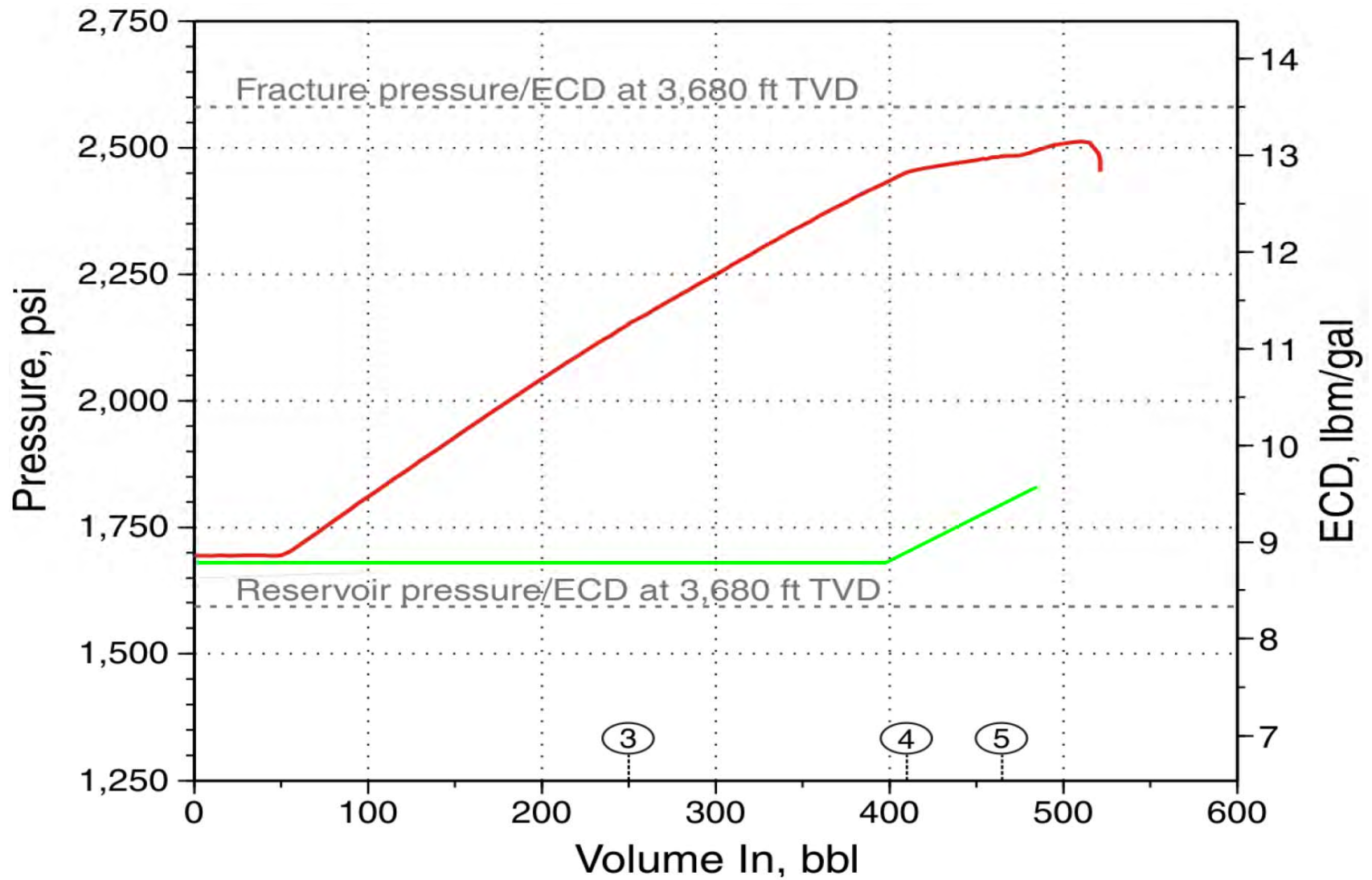
**Figure 4.9:** Traditional downhole cementing process (Bett, 2010).



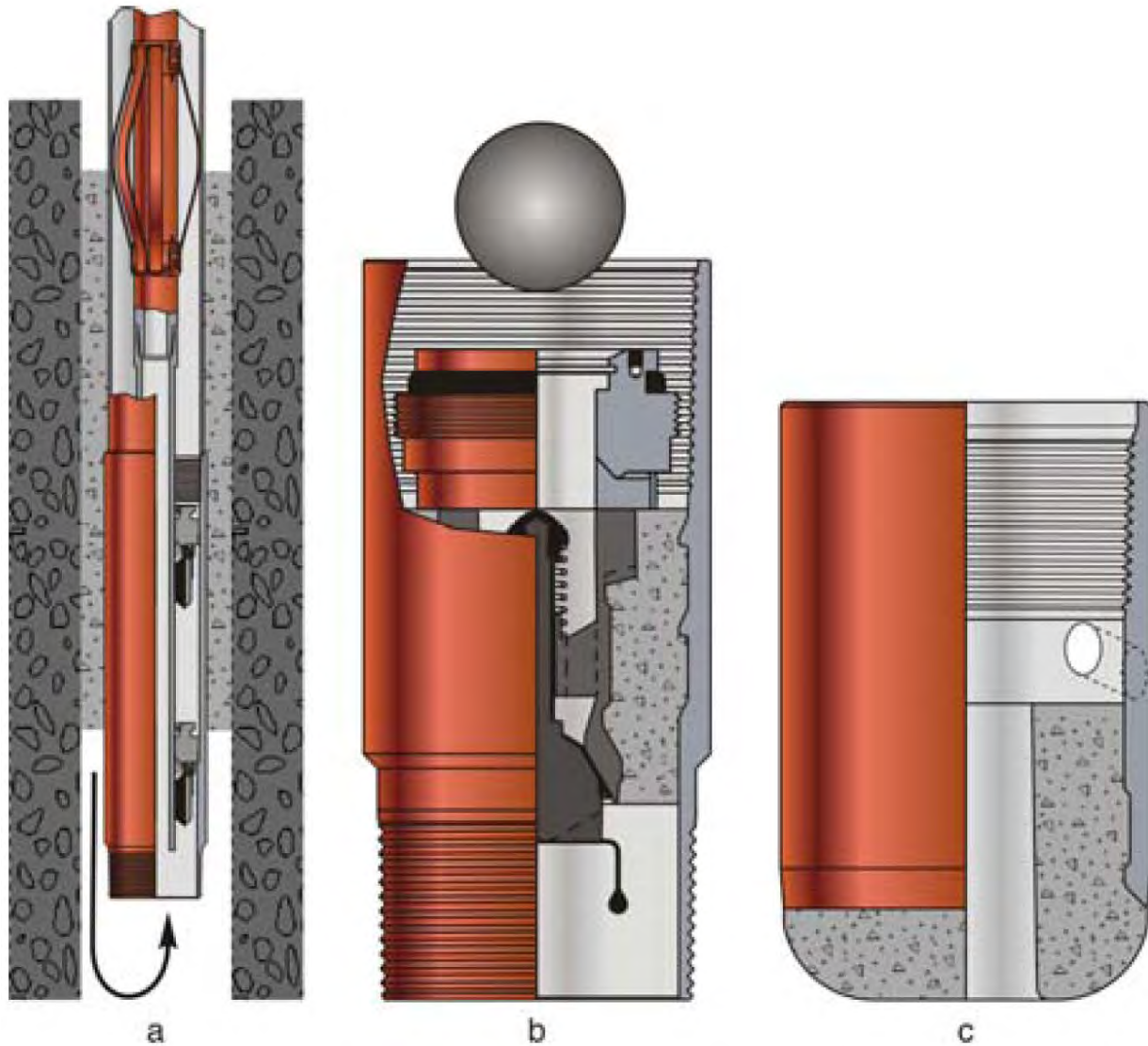
**Figure 4.10:** Inner string cementing process (after Bett, 2010).



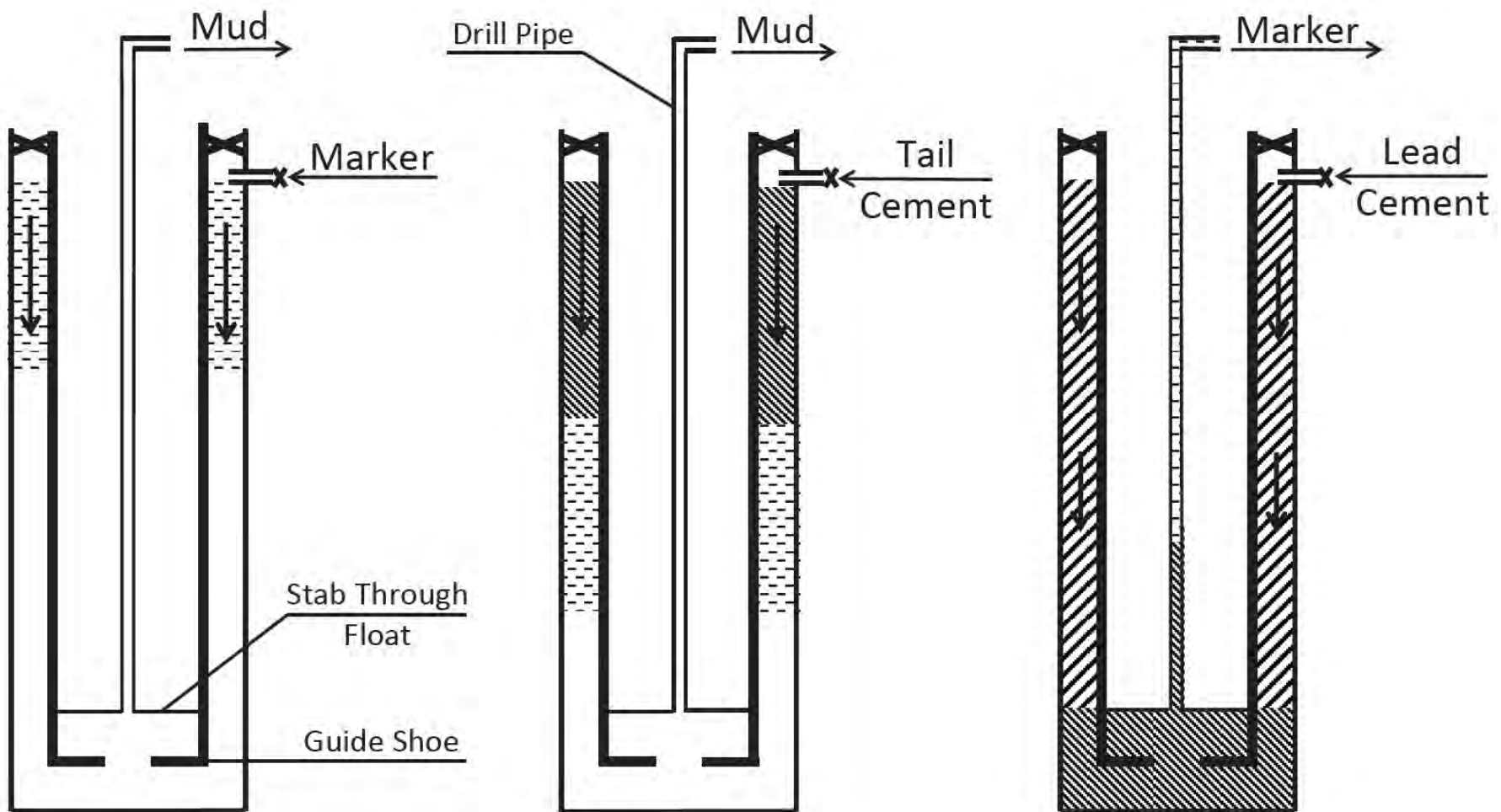
**Figure 4.11:** Reverse circulation cementing flow direction (Hernandez, 2009).



**Figure 4.12:** Conventional vs. reverse circulation ECDs (Hernandez and Bour, 2010).

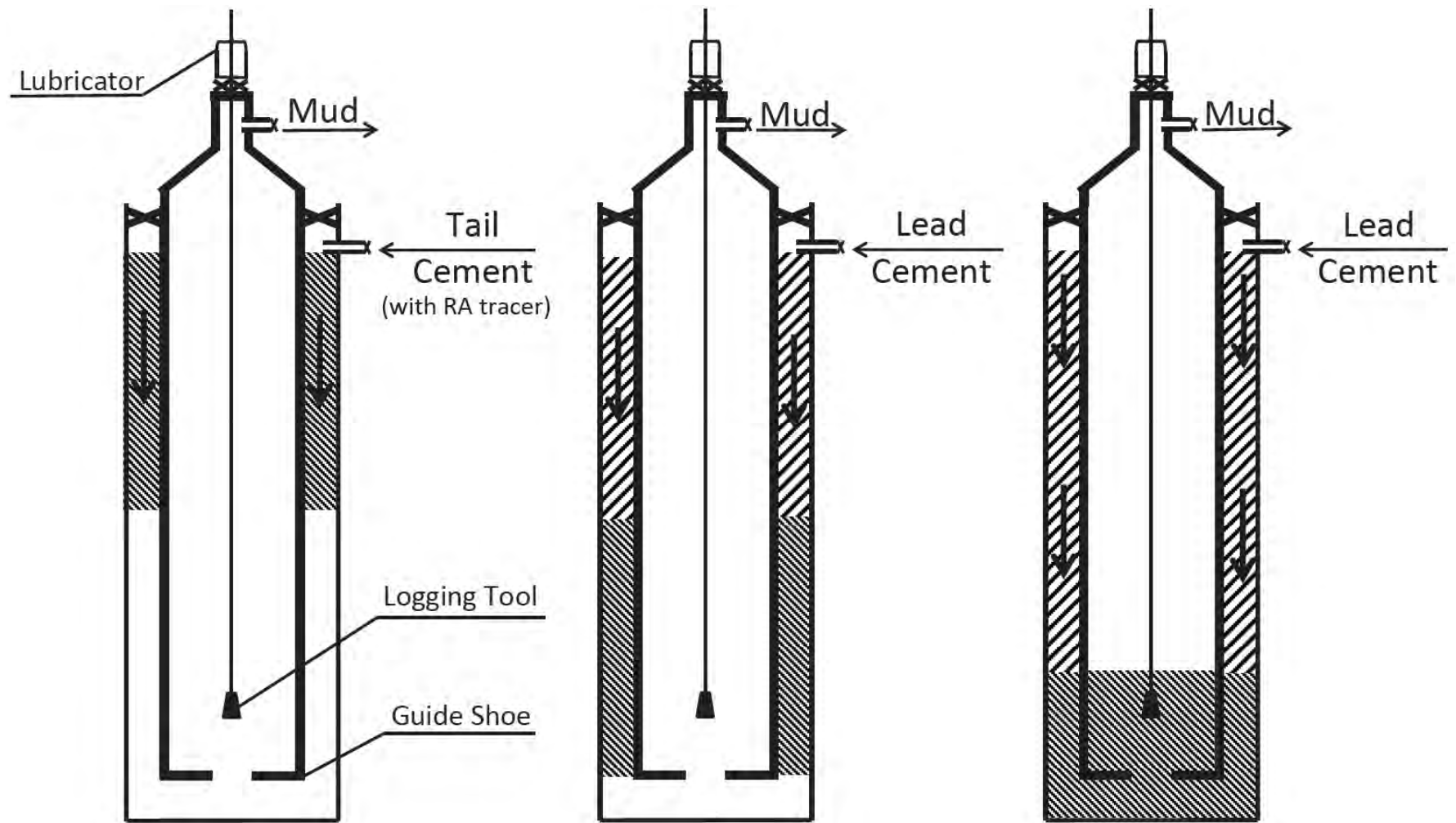


**Figure 4.13:** Reverse circulation float equipment: (a) float and stinger assembly - enables job execution similar to an inner-string cementing procedure; (b) pump-out-valve assembly - can be activated by landing a ball on the valve and shearing the valve from the float collar allowing reverse circulation; (c) conventional guide shoe (Hernandez and Nguyen, 2010).

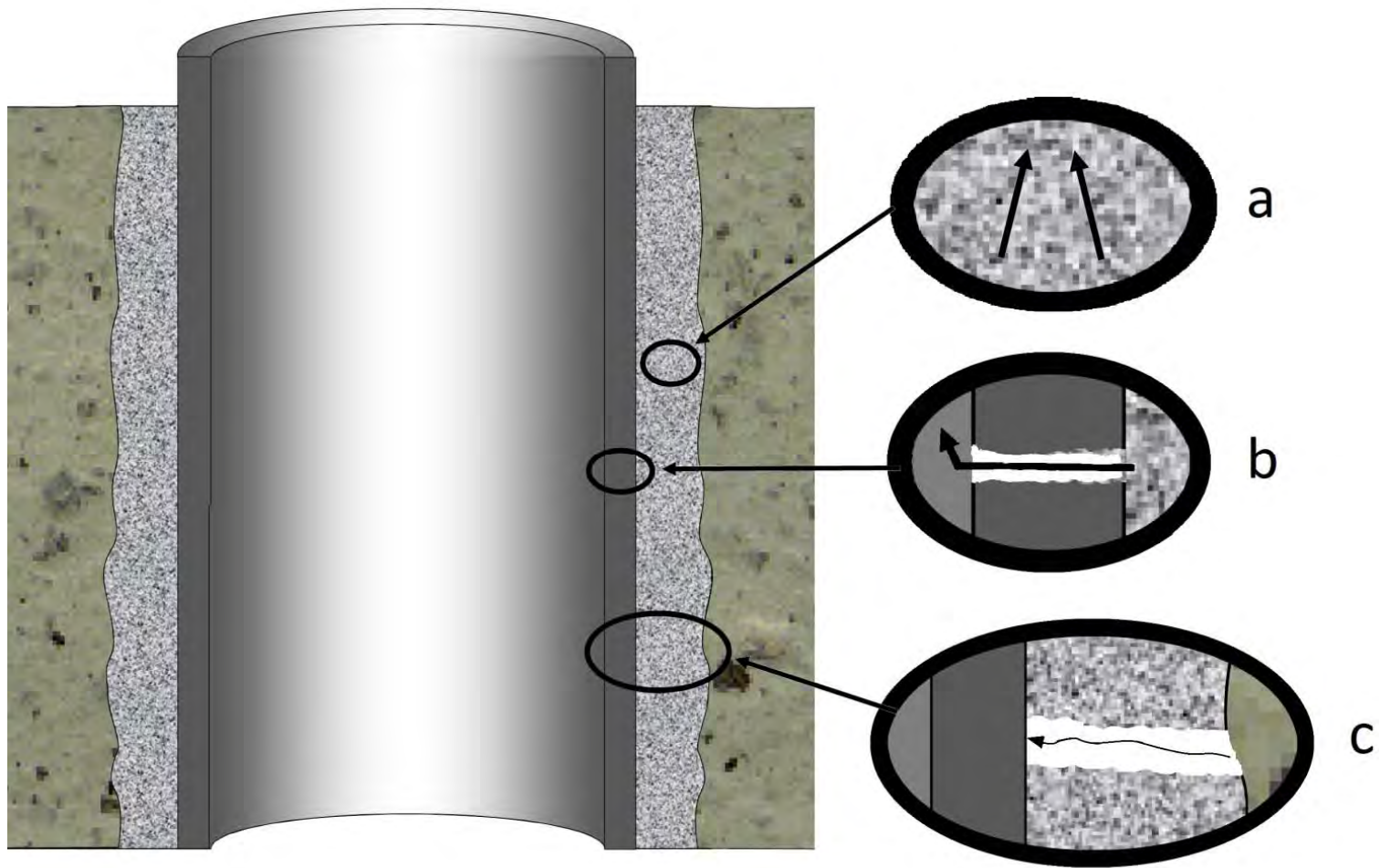


**Figure 4.14:** Reverse circulation method using drill pipe stabbed into float collar (Rickard *et al.*, 2011c).

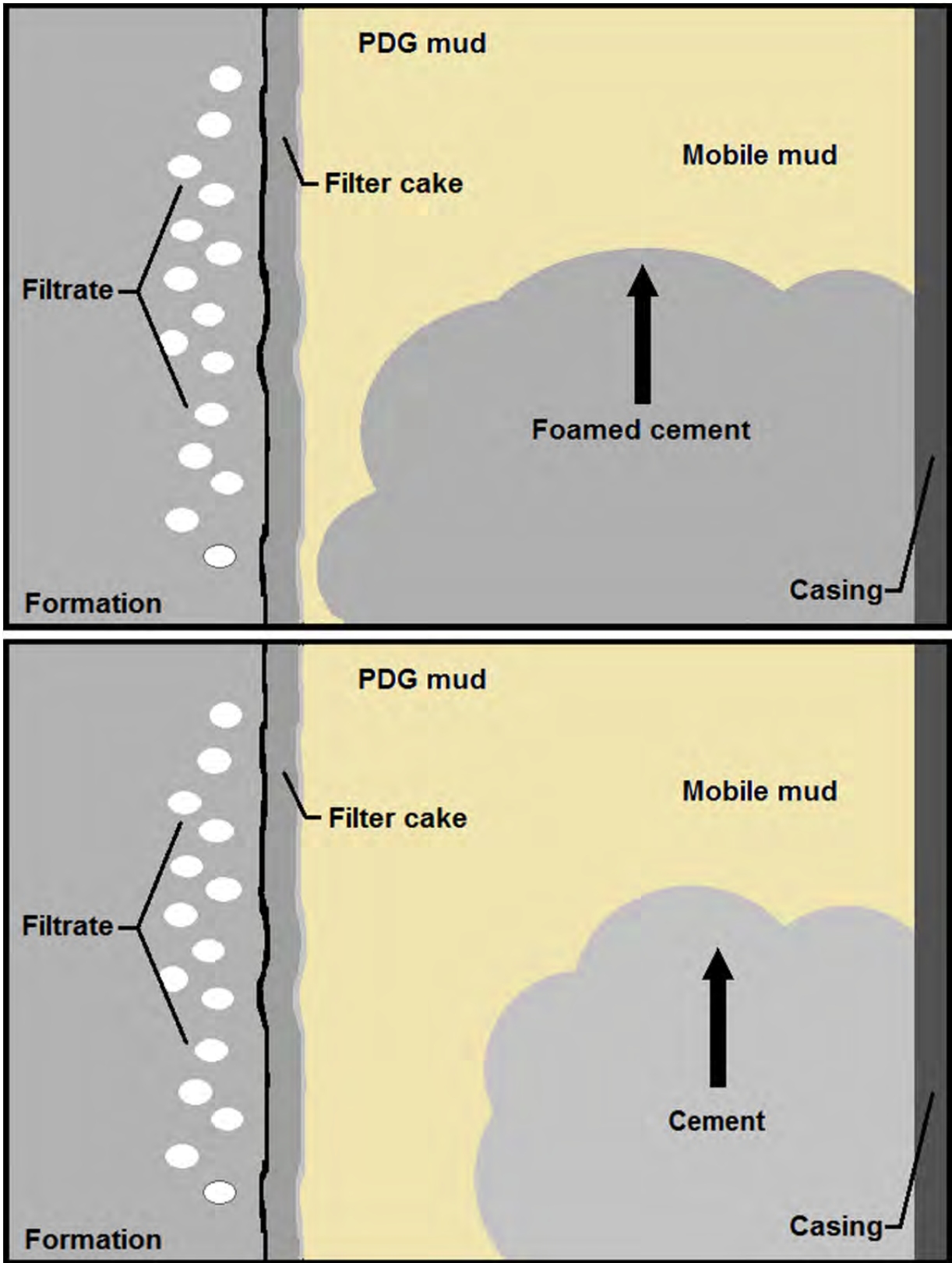




**Figure 4.15:** Reverse circulation method using logging tool and RA tracer (Rickard *et al.*, 2011c).



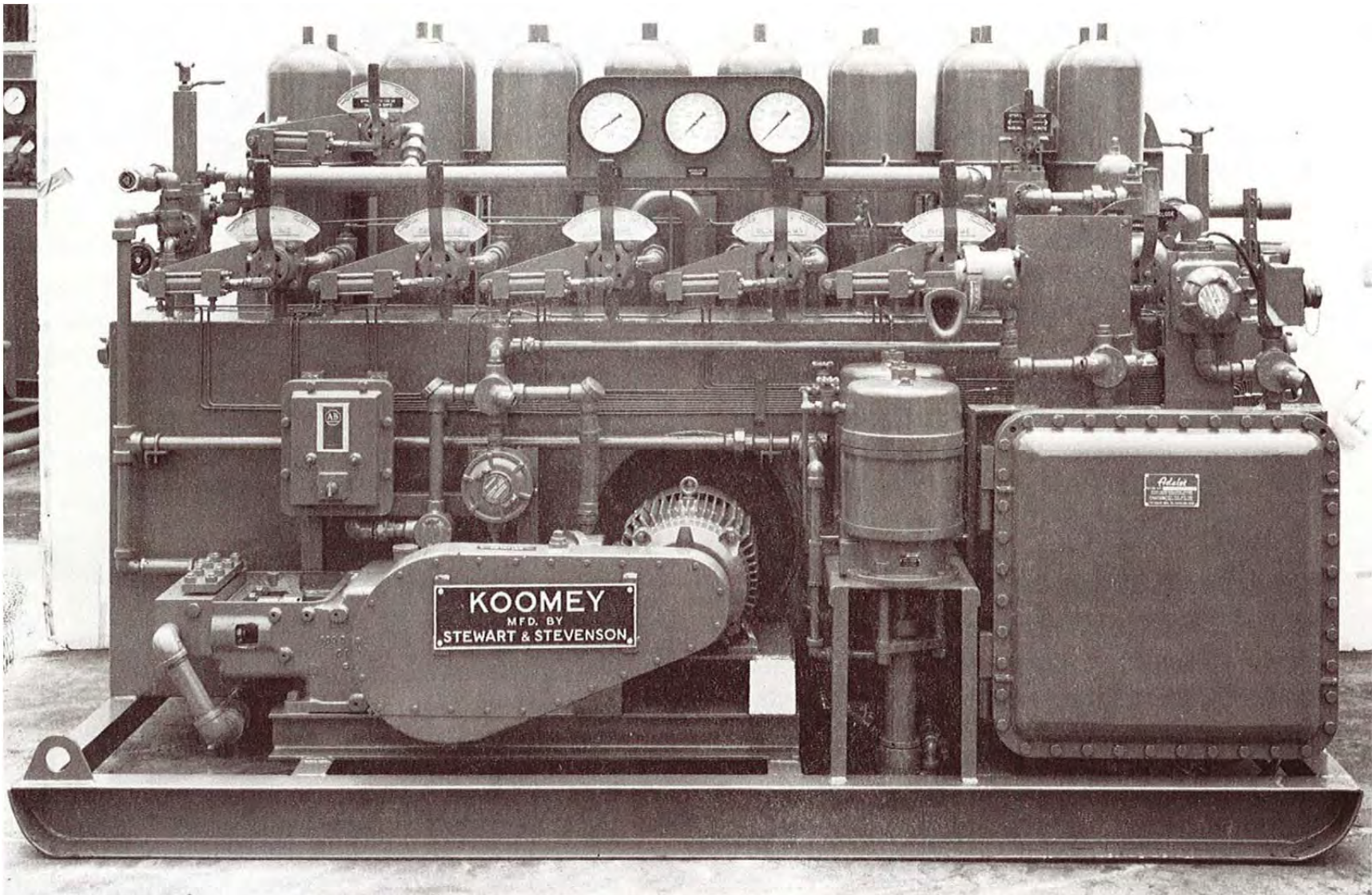
**Figure 4.16:** Carbon dioxide (CO<sub>2</sub>) attack deterioration process in a cemented well: (a) carbonation through permeable cement sheath; (b) carbon steel corrosion; (c) carbonation through cement sheath cracks (Berard *et al.*, 2010).



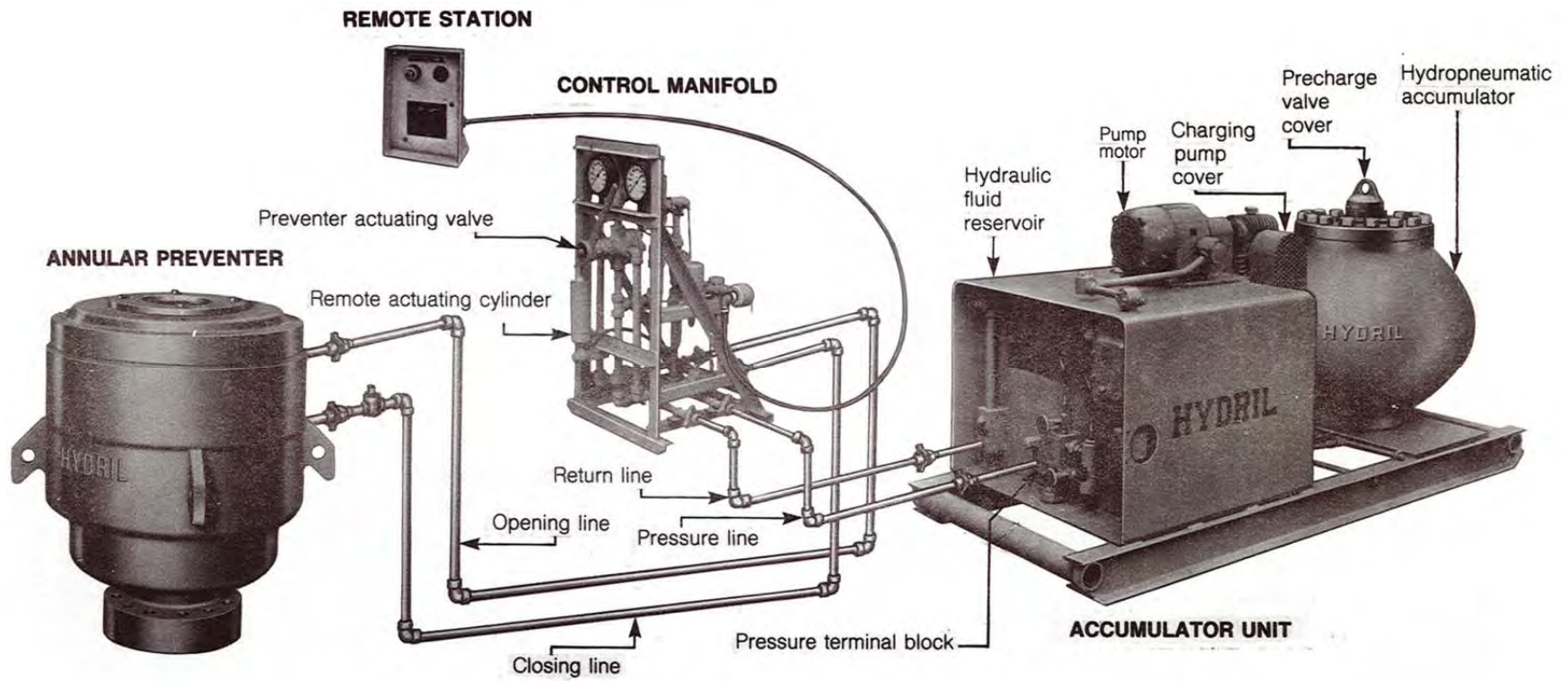
**Figure 4.17:** Mud displacement: foamed cement (top) vs. conventional cement (bottom) (Bour and Rickard, 2000).



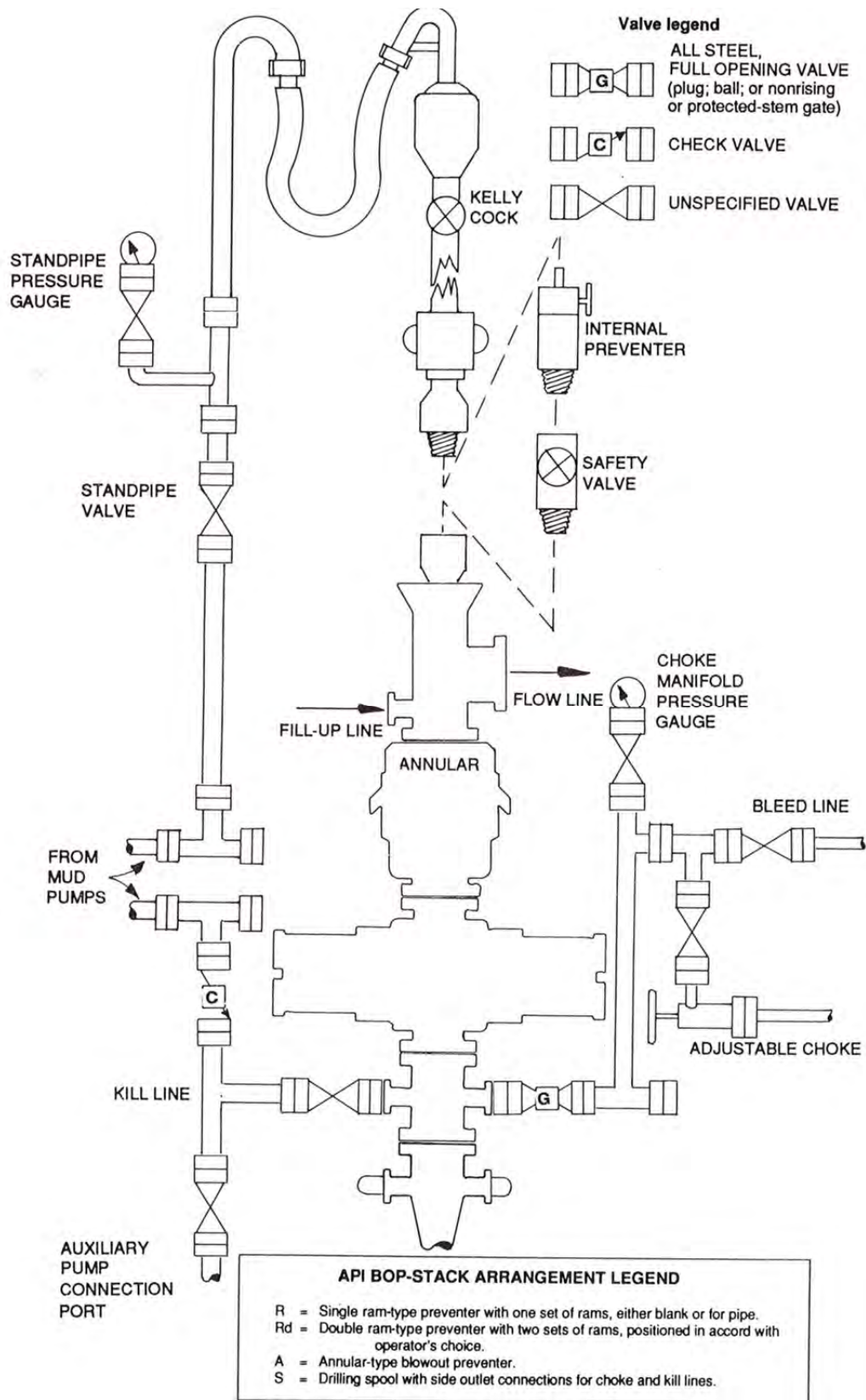
**Figure 5.1:** Hydril type annular preventer (Wygle, 1995).



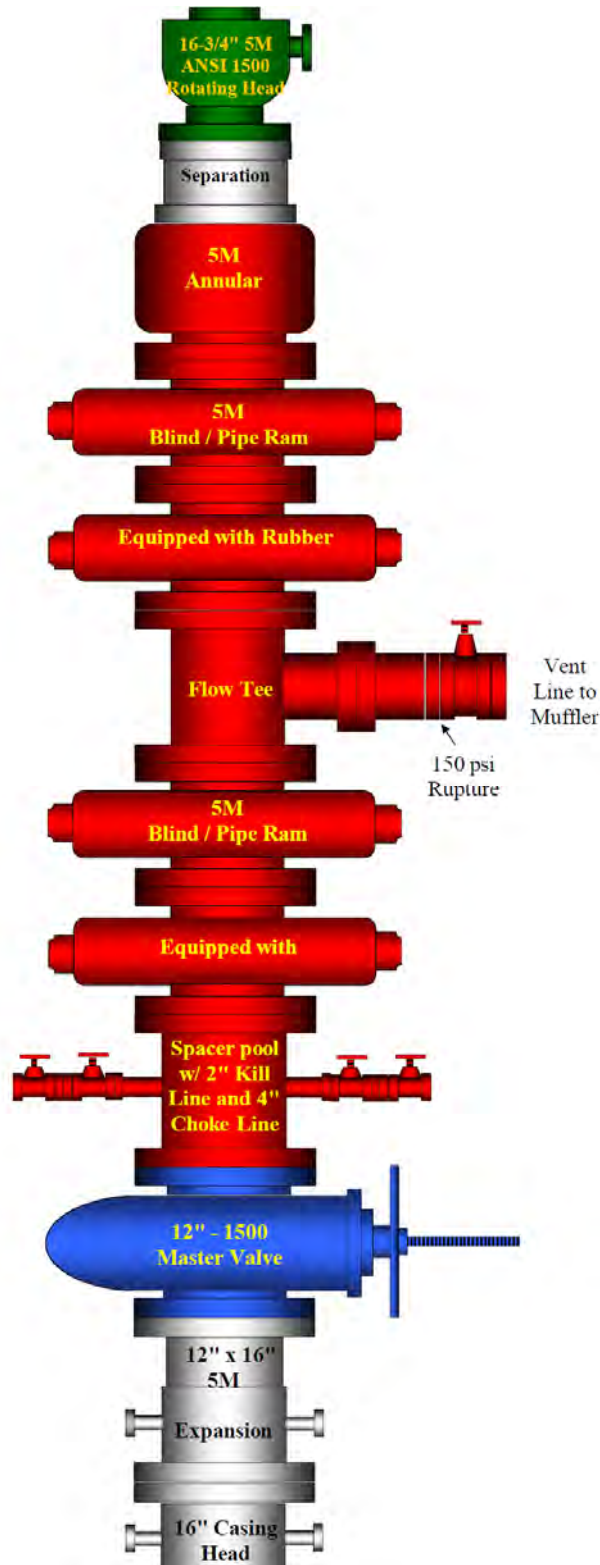
**Figure 5.2:** Typical Koomie accumulator unit (Wygle, 1995).



**Figure 5.3:** Annular preventer and actuating system (Wygle, 1995).

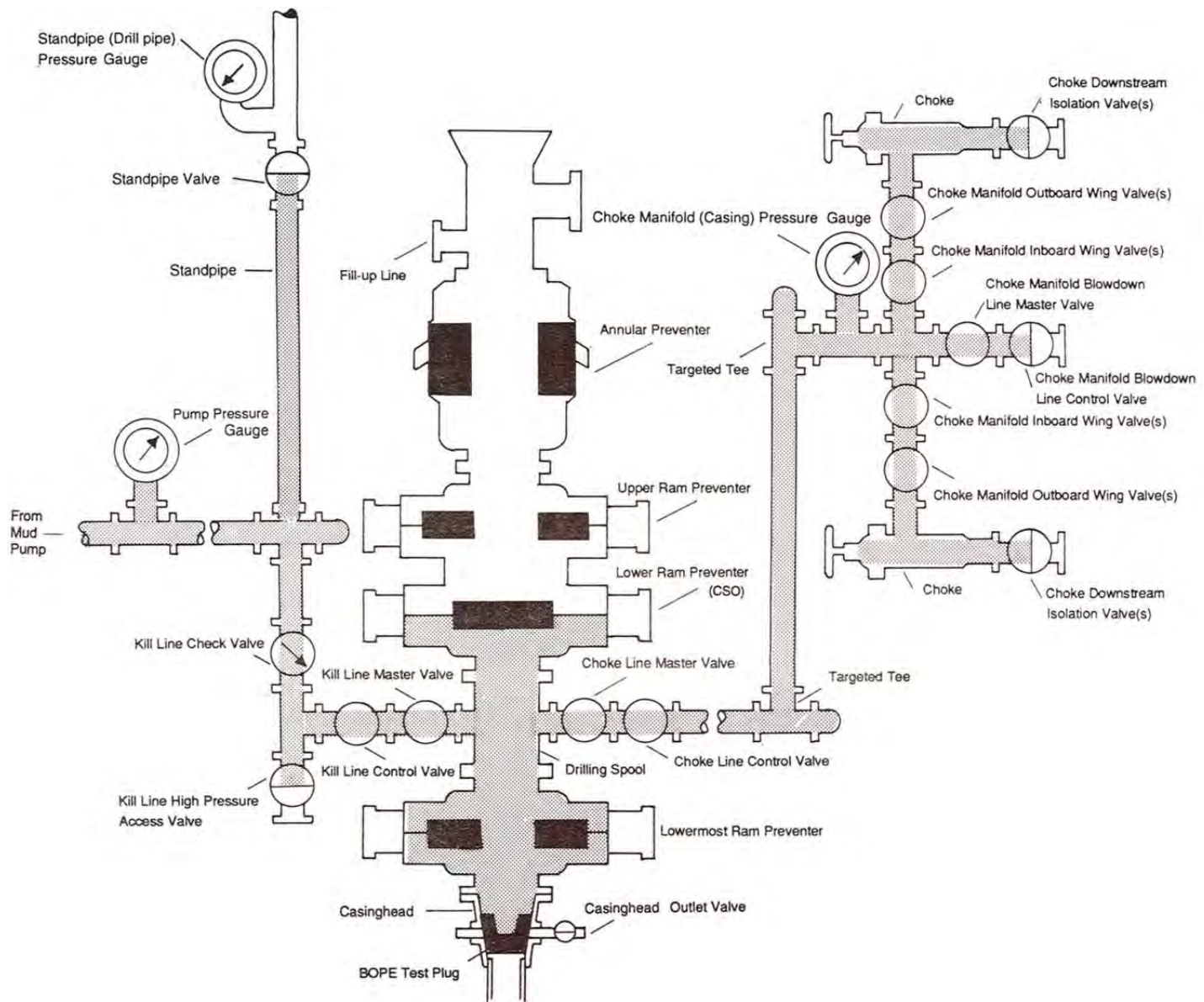


**Figure 5.4:** Class III BOPE installation (API Arrangement SRRA or SRdaA) (Wygle, 1995).

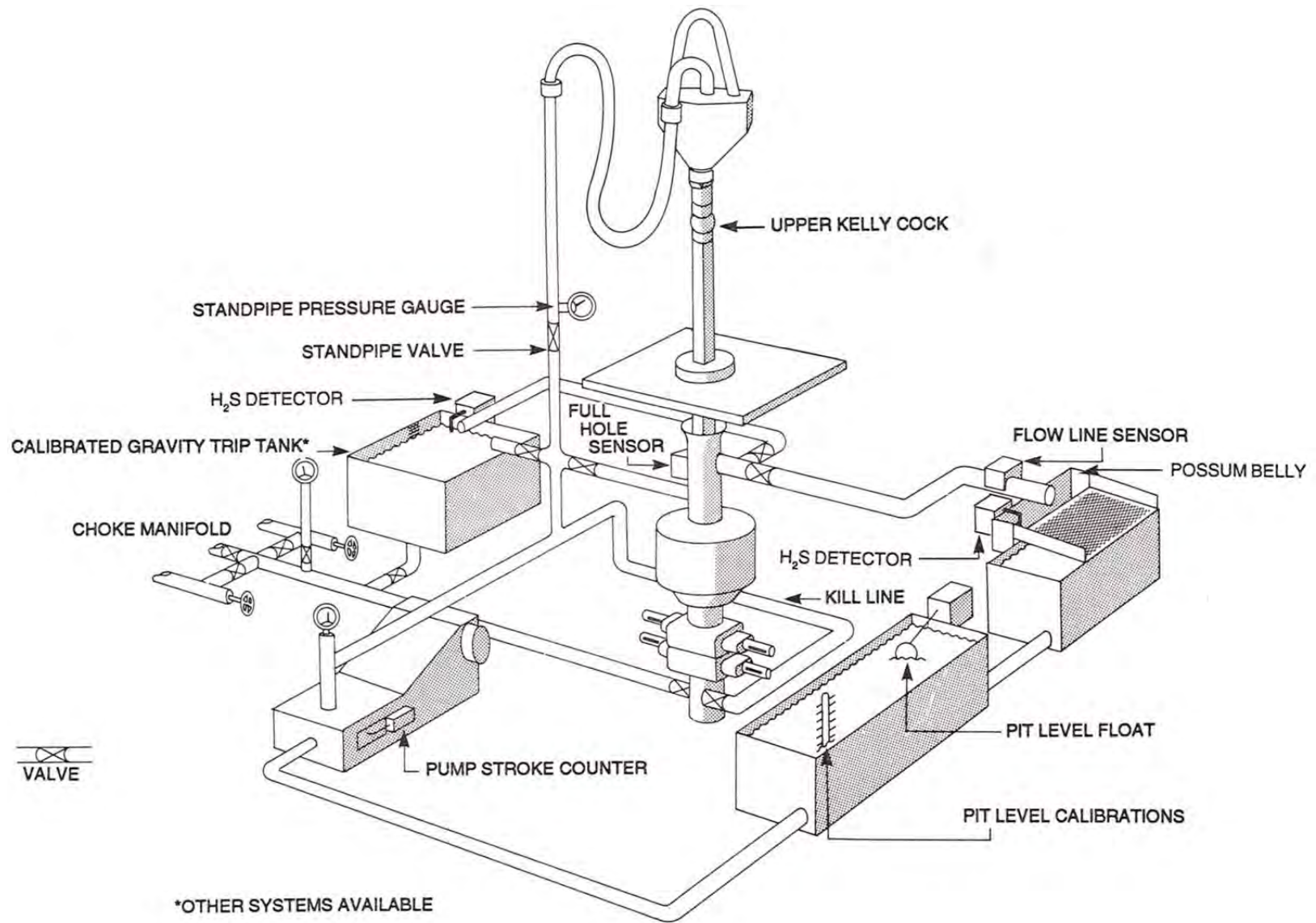


**Figure 5.5:** Class III BOP equipment recommended for use in Hawaii.





**Figure 5.6:** Testing of all connections (except annular preventer) (Wygle, 1995).



**Figure 5.7:** Simplified hole fluid circulating system with monitoring device locations (Wygle, 1995).

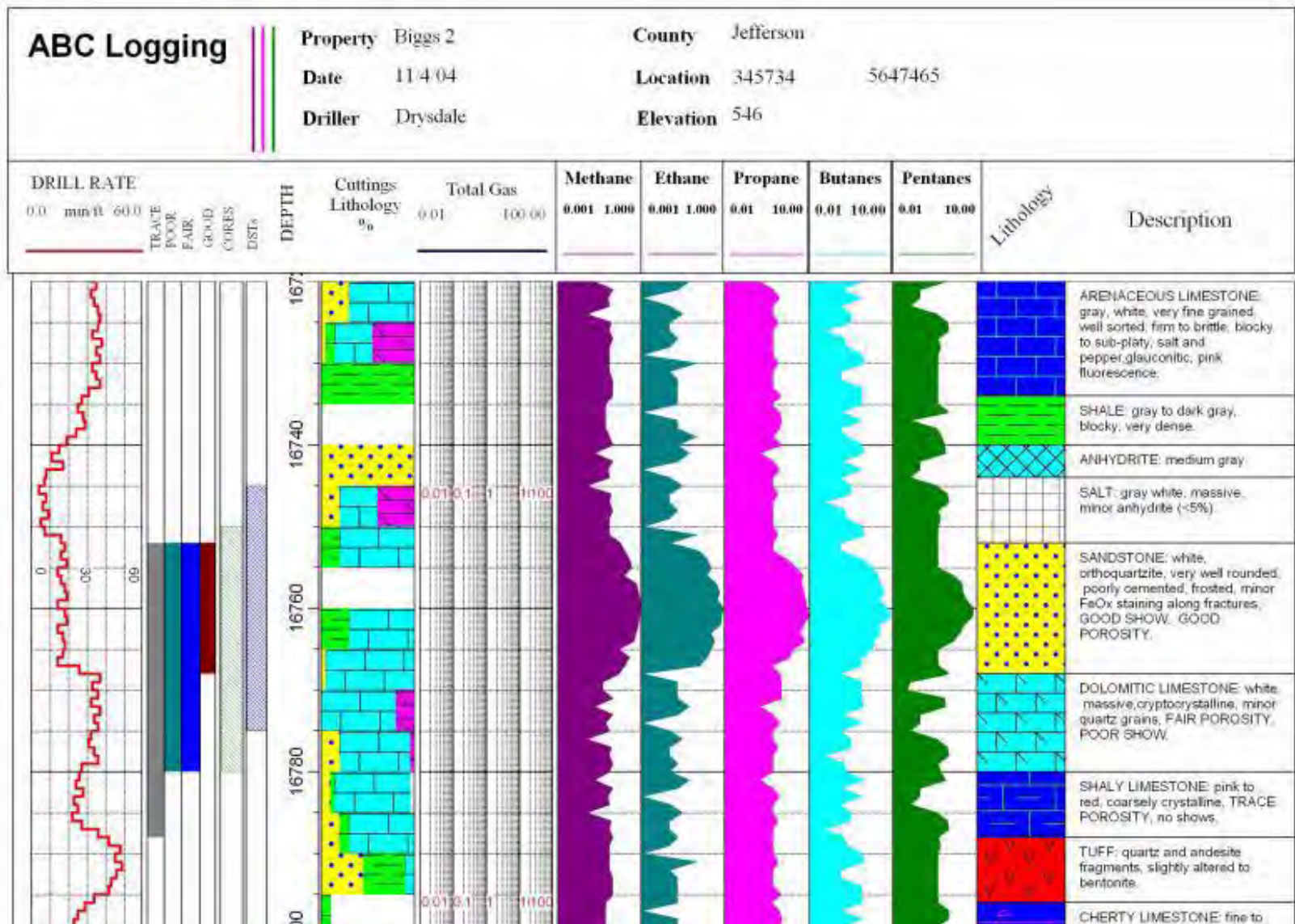


Figure 5.8: Typical mudlog recording lithology, temperature and gas levels.



Figure 5.9: Real-time drilling monitoring equipment.

Daily Drilling Report																			
Well ID:												Well Name:							
Field:				Sect:		Town:		Rng:		County:									
Report No:												Report For 00-Mar-00							
Operator:			Rig:			Proposed TD:			State:										
Measured Depth (ft):			Drilling Days:			RKB Elevation:			County:										
Vertical Depth (ft):			Days On Location:			Last Casing:			Field:										
Hole Made:			Spud Date:			Next Casing:			Working Interest:										
Drilling Hrs:			Average ROP:			Last BOP Test:			Well Bore:										
Personnel: Operator:		Contractor:		Service:		Other:		Total:											
Current Operations:																			
Planned Operations:																			
Toolpusher:																			
Wellsite Supervisors:												Tel No.:							
Operations Summary																			
From	To	Elapsed	End MD(ft)	Code	Operations Description										Non-Prod				
Management Summary																			
Comments																			
Cost/AFE Information																			
AFE No	AFE Description			AFE Amount	Daily Mud	Well Mud	Daily Total	Well Total	% Spent										
Mud Information																			
%										Gels			Temp						
Density	Vis	PV	YP	Filt.	Cake	pH	Solids	Oil	Water	Sand	Chloride	Calcium	10s	10m	30m	In	Out		
Bit/BHA Information																			
No Run			Make			Model		Diam		Depth		This Run		R.O.P.		Mud		Pump	
In	Dist	Hrs	Avg	Max	WOB	RPM	Torque	Wt	Flow	Press	J. Vel	P. Drp	HHP	JIF					
Rig Information																			
Solids Control Information																			
Safety Information																			
Meetings/Drills	Time			Description															

Figure 7.1: Daily Drilling Report sample.

**Well History Report**

Well:	
Operator:	
Rig:	

<b>Report Date: (days)</b>	<b>Depth (KB): (feet)</b>	<b>Progress: (feet)</b>	<b>Operation</b>
Day 1			
Day 2			
Day 3			
Day 4			
Day 5			

**Figure 7.2:** Well History Report sample.

UNITED STATES  
DEPARTMENT OF THE INTERIOR  
BUREAU OF LAND MANAGEMENT  
**MONTHLY REPORT OF GEOTHERMAL OPERATIONS**

FORM APPROVED  
OMB NO. 1004-0132  
Expires: December 31, 2013

<p>The Bureau of Land Management (BLM) requires this form or other BLM approval forms (computerized, company, State, etc.) to be prepared for each month beginning with the month in which drilling is initiated and filed in <b>duplicate</b> with the BLM, on or before the last day of the month following unless exception is granted by the BLM.</p> <p>The following is a complete and accurate report of all operations and production for the Month of _____, 20_____.</p> <p>Signed: _____ Title: _____ Date: _____</p>	<p>3. Lease Serial No. _____</p> <p>4. Surface Manager: <input type="checkbox"/> BLM <input type="checkbox"/> FS <input type="checkbox"/> Other _____</p> <p>5. Unit Agreement Name _____</p> <p>6. Field or Area _____</p> <p>7. County _____</p> <p>8. State _____</p>
<p>1. Name of Lessee/Operator _____</p> <p>2. Address of Lessee/Operator _____</p>	

9. INDIVIDUAL WELL PRODUCTION

TWSP, RGE SEC., B&M	WELL NUMBER	TYPE (STATUS)	DAYS PROD. OR INJ.	MONTHLY PRODUCTION OR INJECTION			PRODUCTION OR INJECTION RATE			AVERAGE		
				TOTAL (lb)	STEAM (lb)	WATER (lb)	TOTAL (lb)	STEAM (lb)	WATER (lb)	TEMPERATURE IN °F	TEMPERATURE OUT °F	PRESSURE psi

10. OPERATIONS CONDUCTED DURING MONTH: Describe Drilling, Remedial Drilling, Redrilling, Stimulation, Testing and other Well Work Performed.

TWSP, RGE, SEC., B&M	WELL NUMBER	OPERATIONS CONDUCTED	MONTH END STATUS

Remarks: *(use additional pages if needed)*

**GENERAL INSTRUCTIONS**

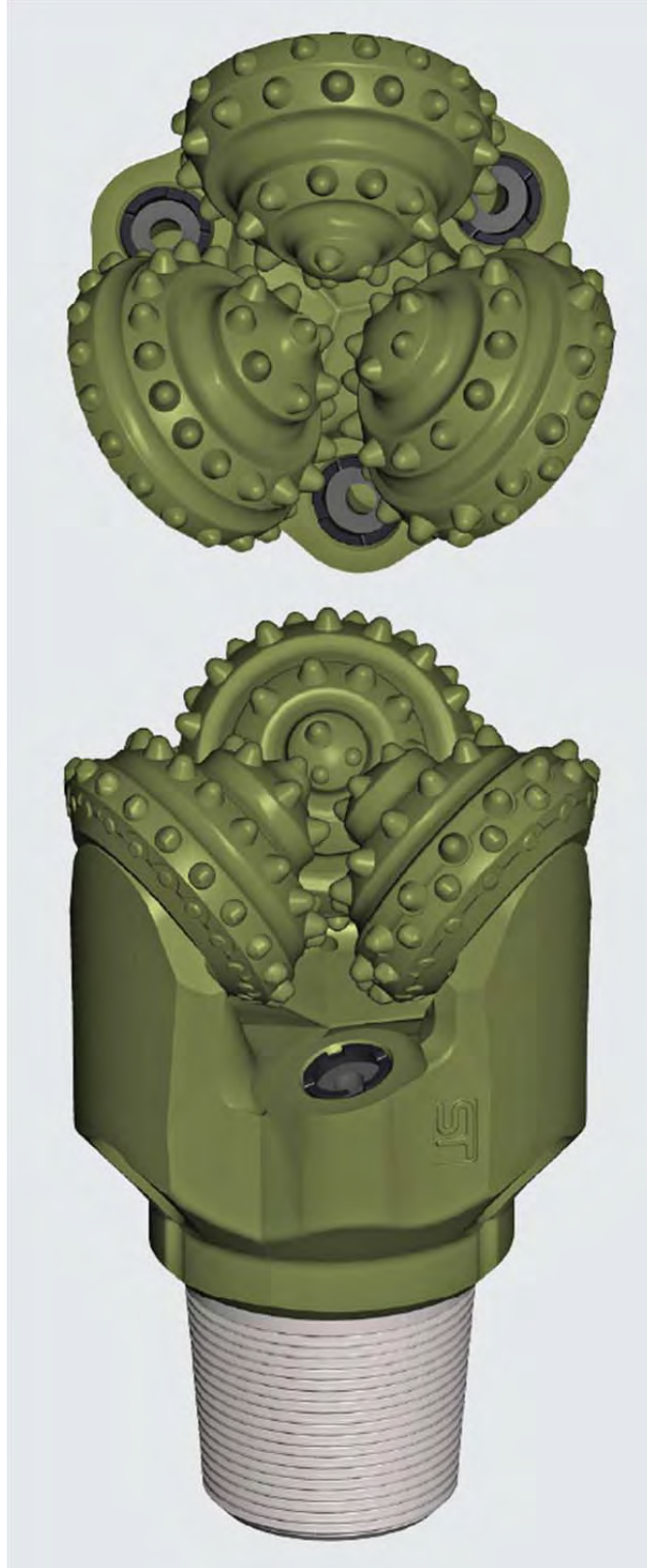
This form is designed for submitting a complete and accurate account of monthly activity and performance of geothermal wells and production facilities on Federal leases. The report must include wells on the lease that have not been abandoned.

**Figure 7.3: Monthly Operating Report sample (USDOI, 2014b).**

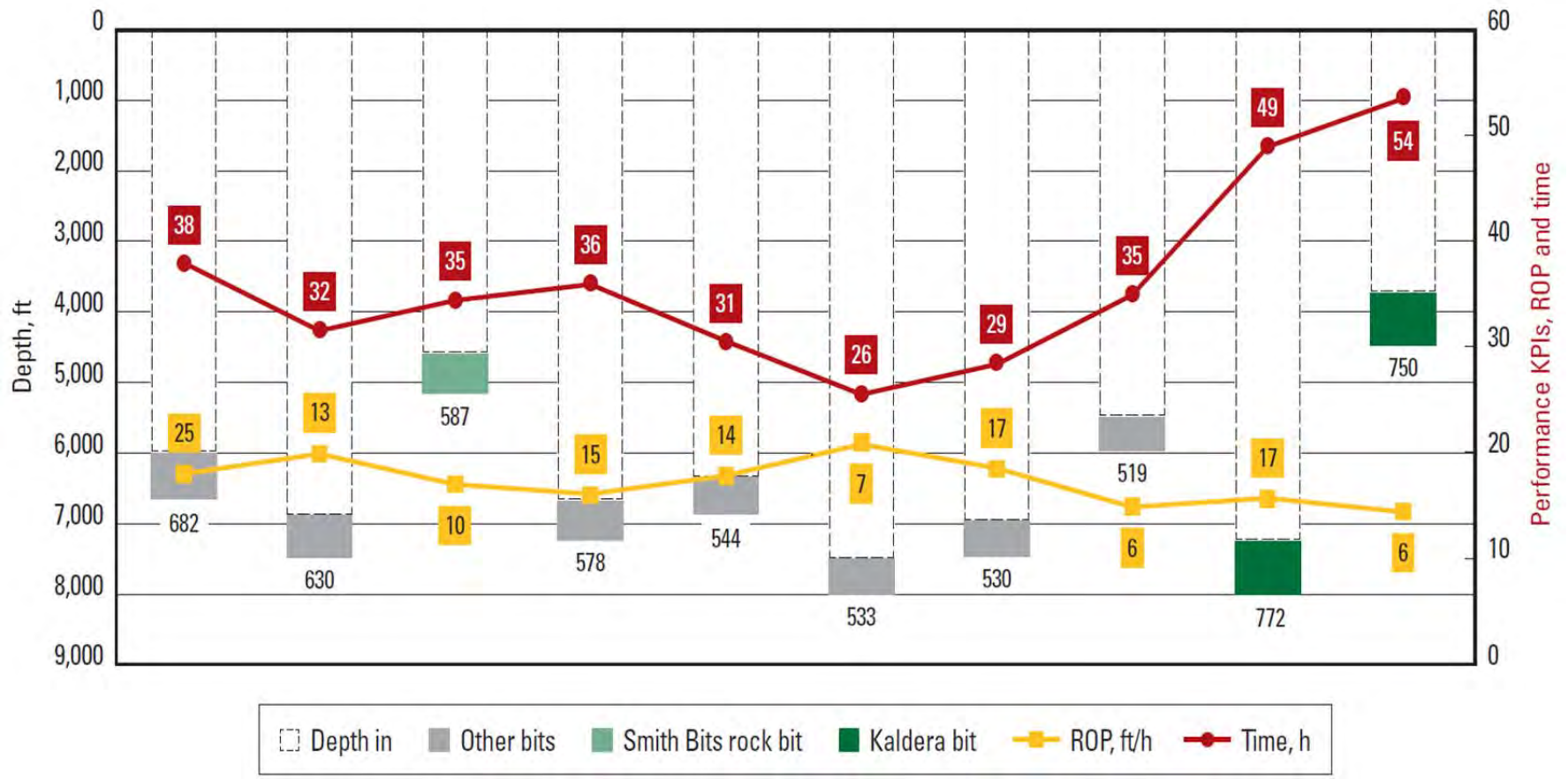


**Figure 8.1:** Calcite scaling inside liner – note plugged slots (Thorhallsson, 2003).

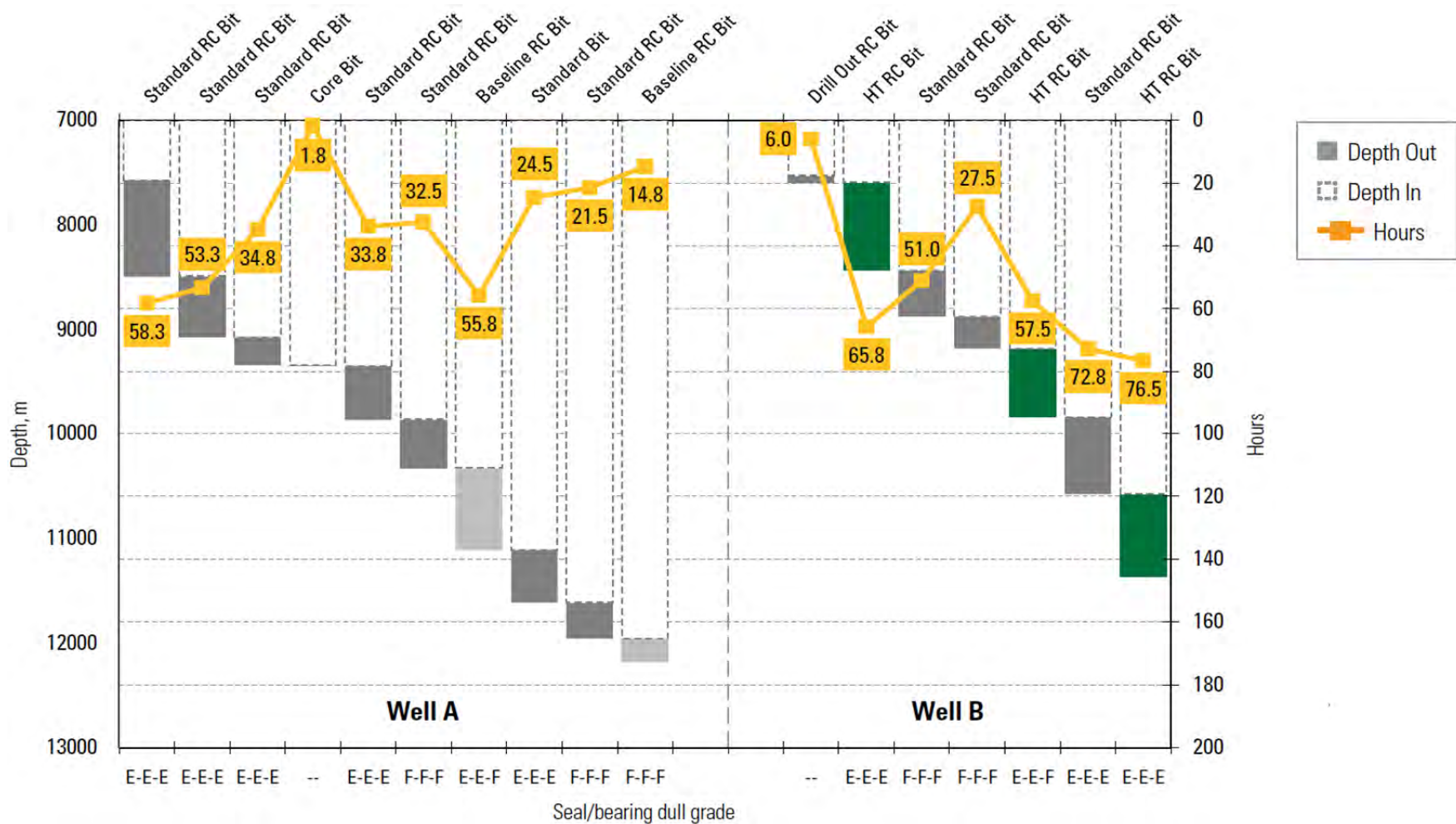




**Figure 9.1:** Kaldera high-temperature roller cone drill bit (Schlumberger, 2013).



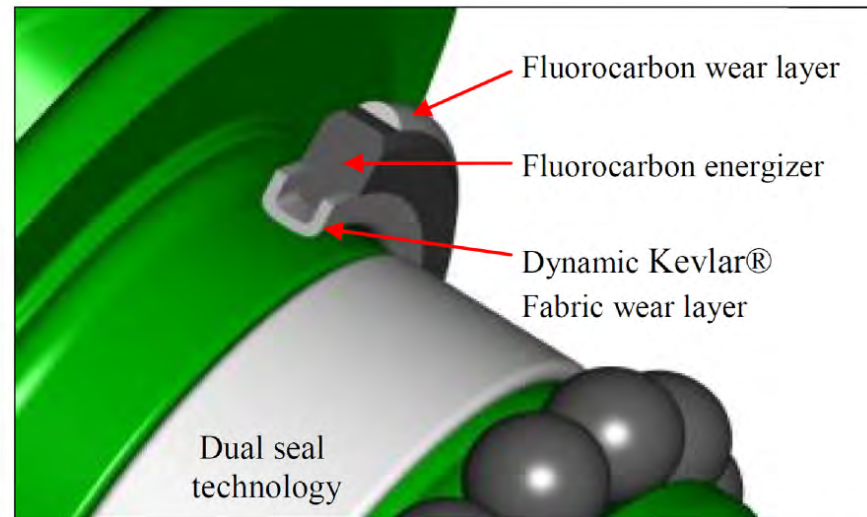
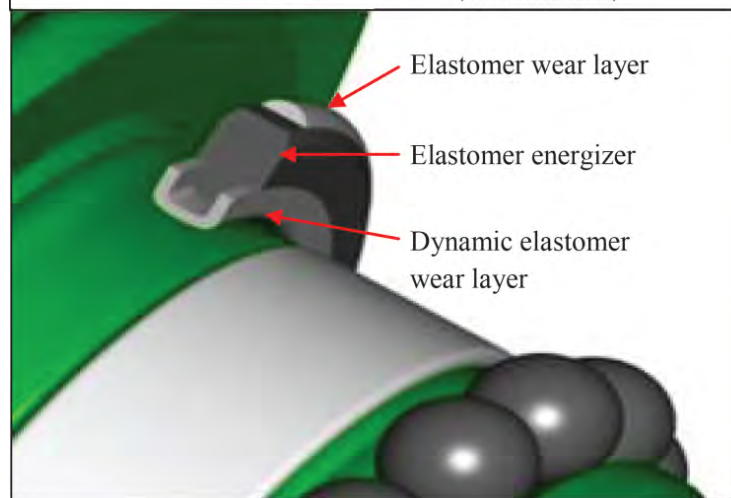
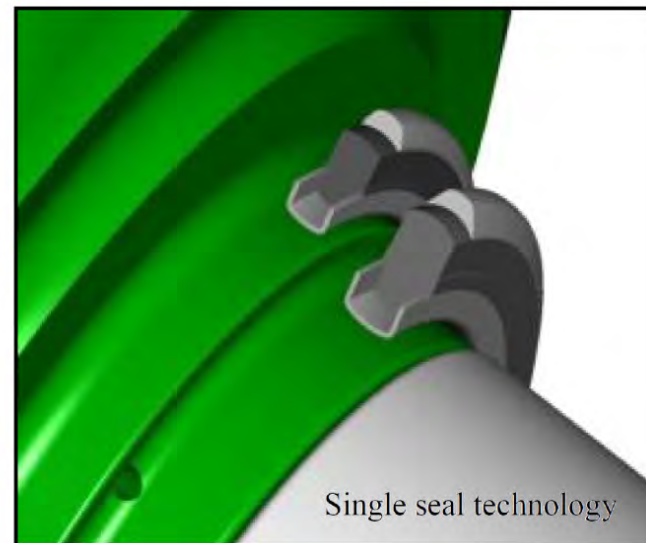
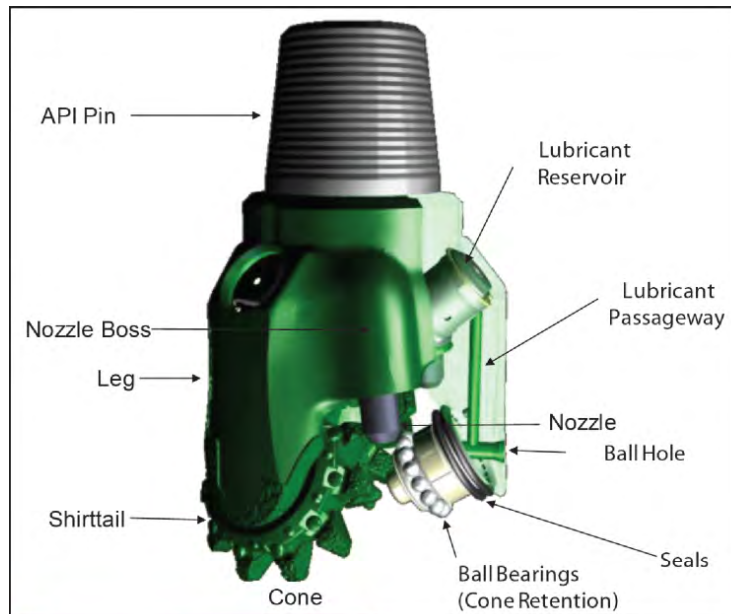
**Figure 9.2:** Kaldera drilling results at The Geysers: The Kaldera bit drilled 14 hours longer and approximately 150 feet farther than other bits, representing a run length increase of 25% (Schlumberger, 2013).



**Figure 9.3:** Kaldera drilling results at Larderello: The Kaldera bit drilled more footage and reduced bit consumption by 30% compared to an offset well drilled with baseline roller cone products. The performance improvement reduced operator drilling costs and shortened time to production (Schlumberger, 2011).



**Figure 9.4:** Kymera hybrid drill bit (Baker Hughes, 2011).



**Figure 9.5:** LEFT: Basic roller cone technology (top) and schematic of RC seal on journal bearing (bottom); RIGHT: New HT/HP seal packages in single configuration (top) and dual configuration (bottom) (Orazzini *et al.*, 2011).

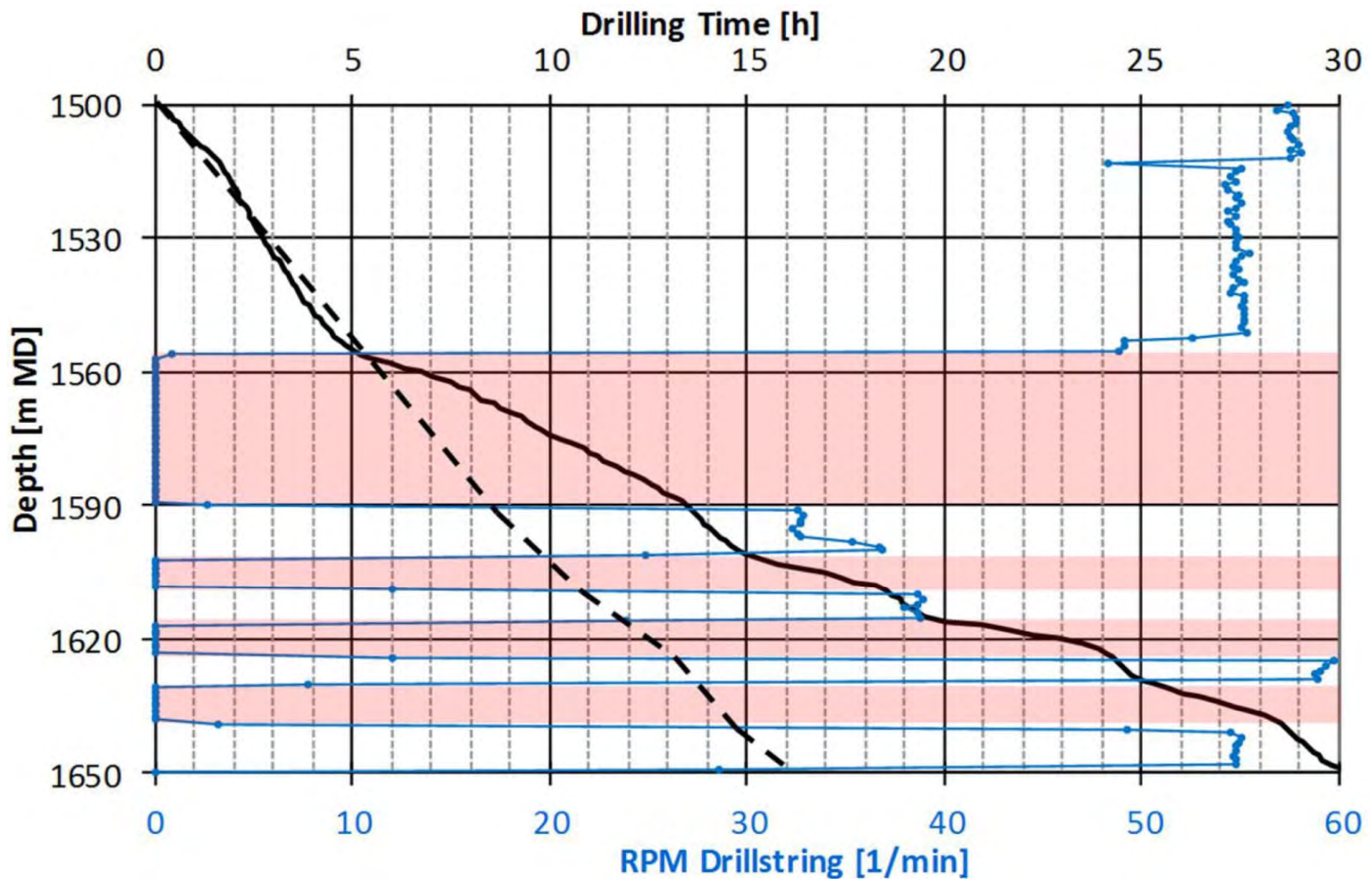
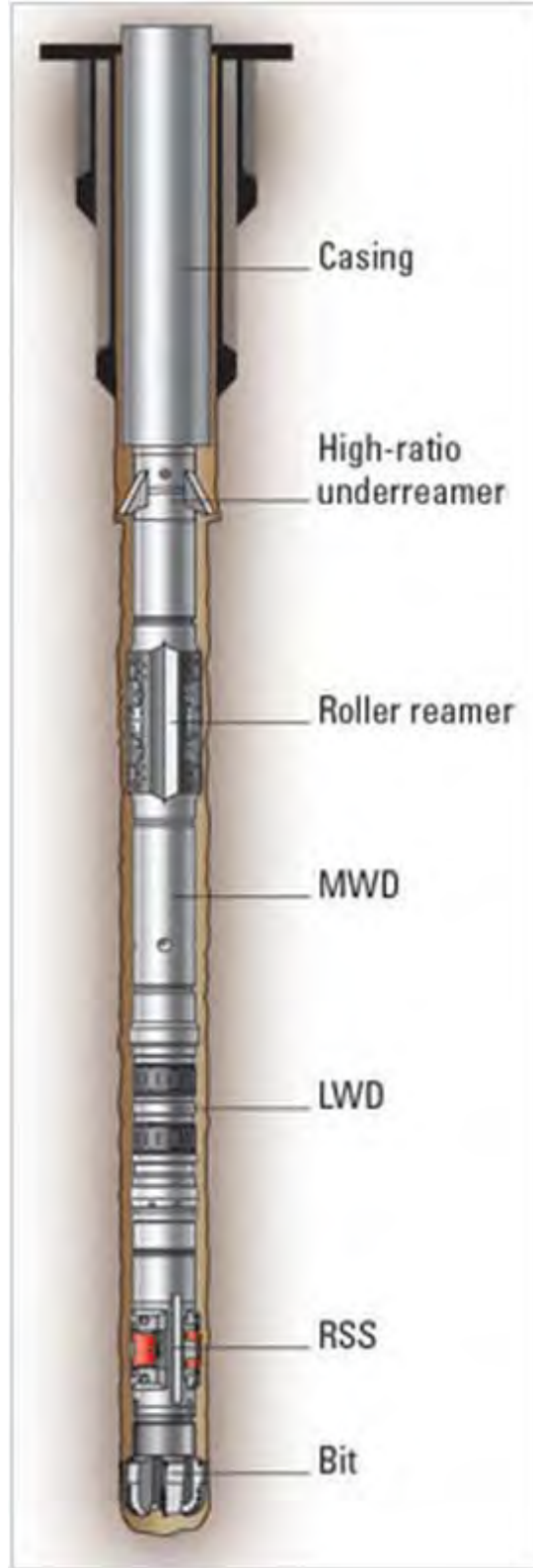
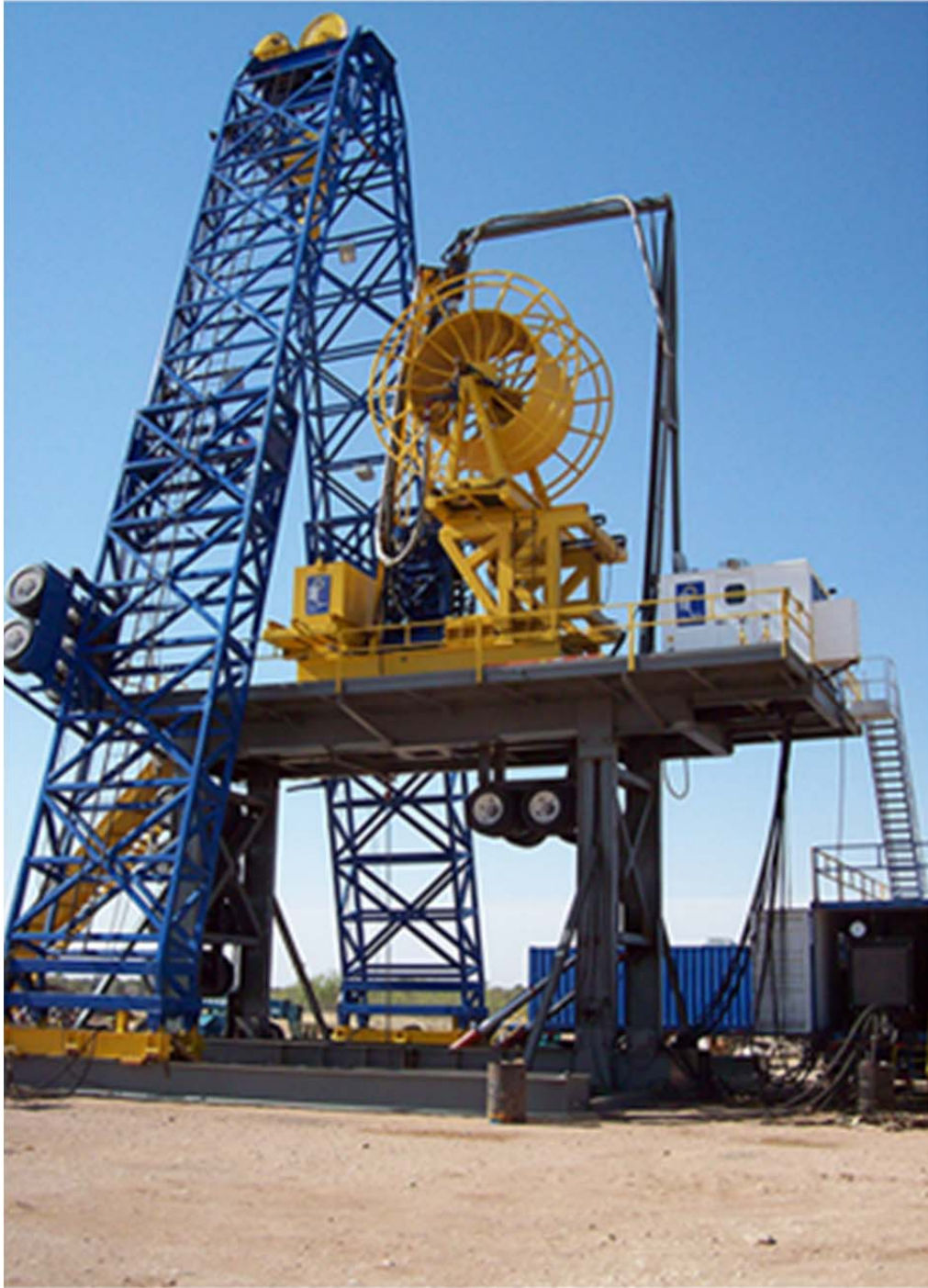


Figure 9.6: Example of ROP behavior while “sliding (red intervals) and “rotating” (white intervals), (Lentsch *et al.*, 2012).

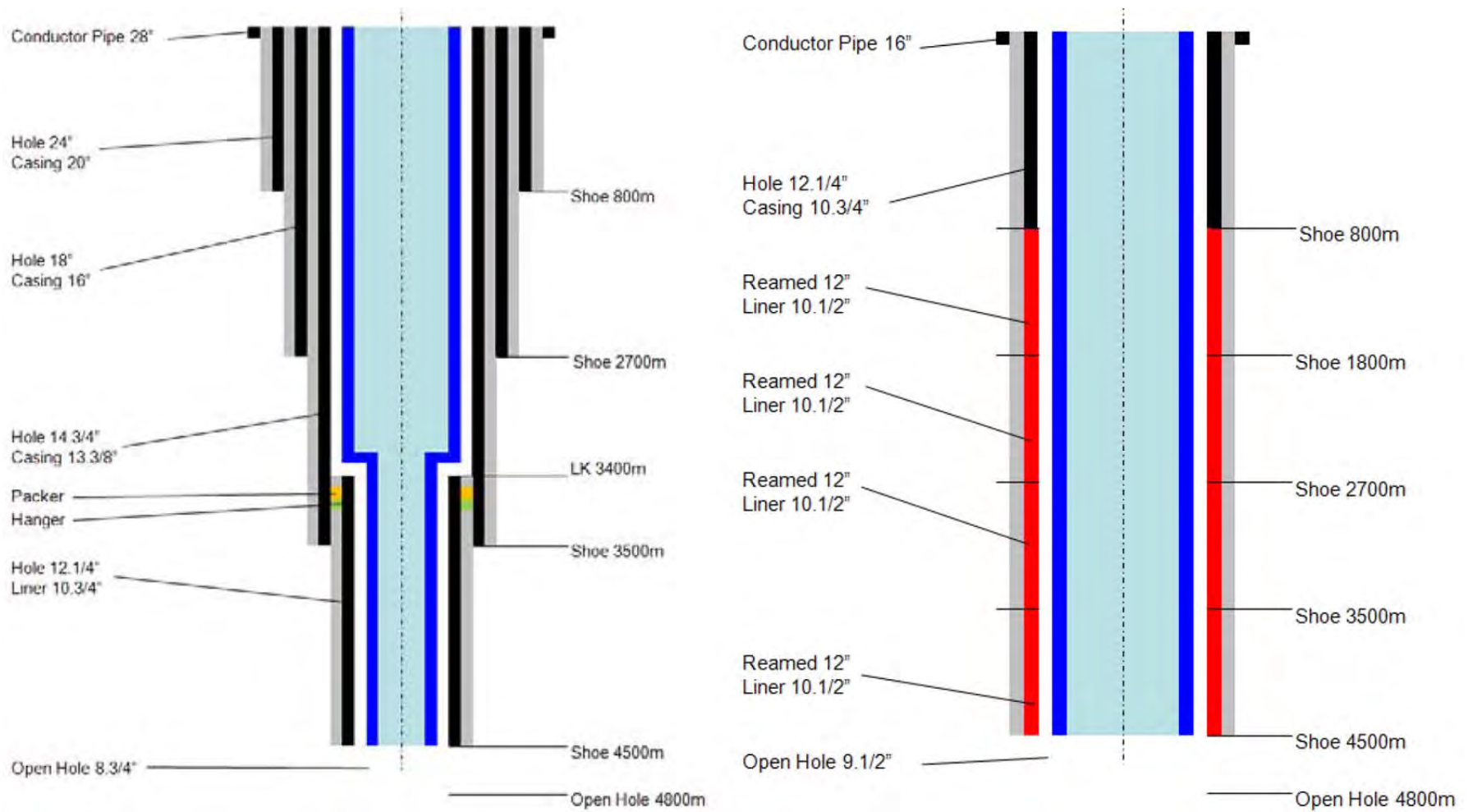


**Figure 9.7:** Casing While Drilling (CWD) assembly (Schlumberger, 2014c).



**Figure 9.8:** Coiled tubing rig “revolver” (Reel Revolution Holdings, Ltd., 2014).





**Figure 9.9:** Comparison of standard and Mono-diameter design for synthetic deep well, (Oppelt and Lehr, 2012).

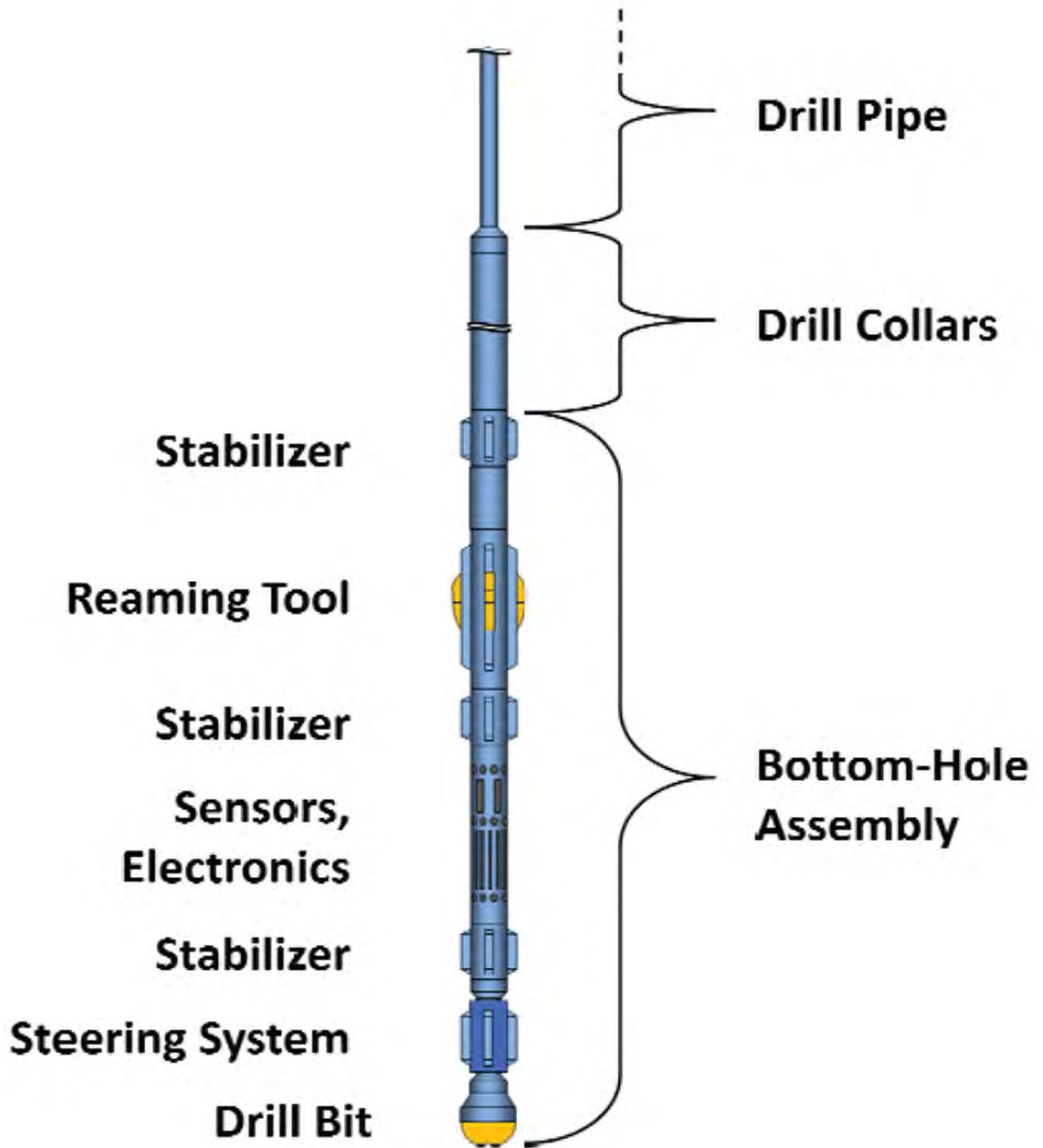
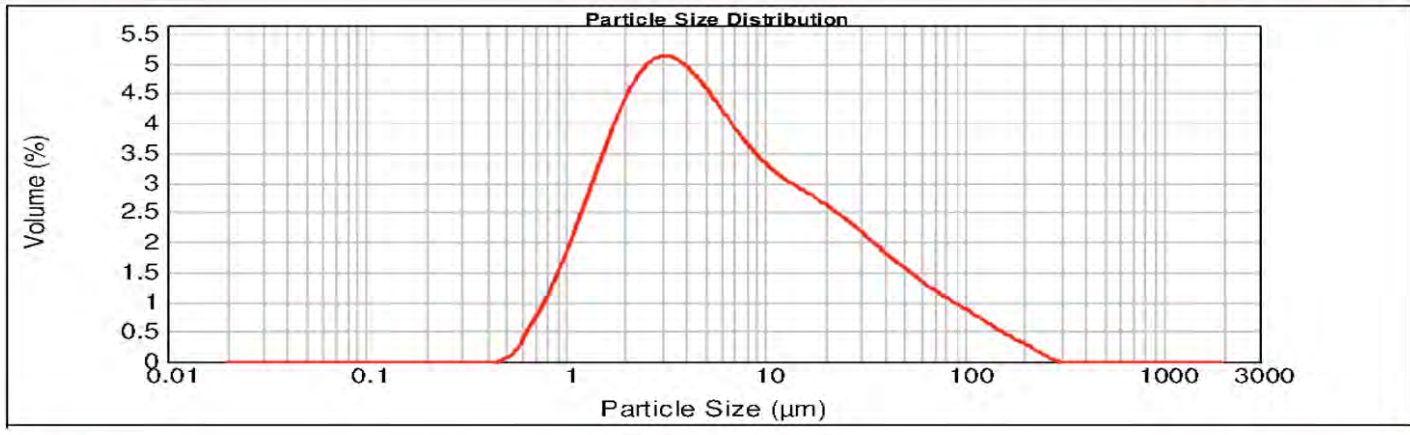
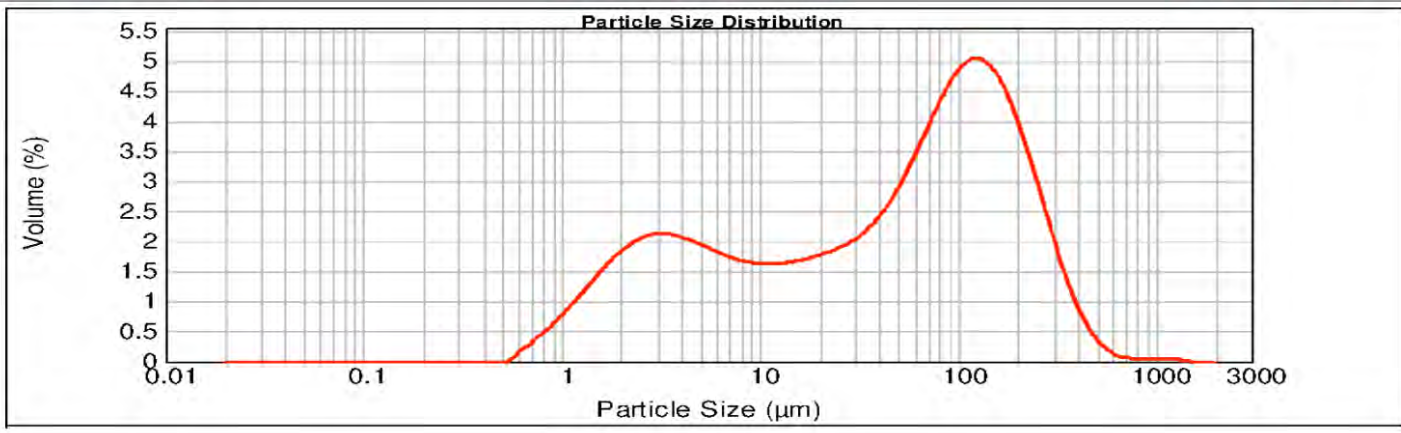


Figure 9.10: Monobore drilling BHA (Oppelt and Lehr, 2012).

<b>Concentration:</b> 0.0049 %Vol	<b>Span :</b> 7.756	<b>Uniformity:</b> 2.58	<b>Result units:</b> Volume
<b>Specific Surface Area:</b> 1.71 m <sup>2</sup> /g	<b>Surface Weighted Mean D[3,2]:</b> 3.515 um	<b>Vol. Weighted Mean D[4,3]:</b> 16.608 um	
<b>d(0.1):</b> 1.451 um	<b>d(0.5):</b> 5.405 um	<b>d(0.9):</b> 43.374 um	



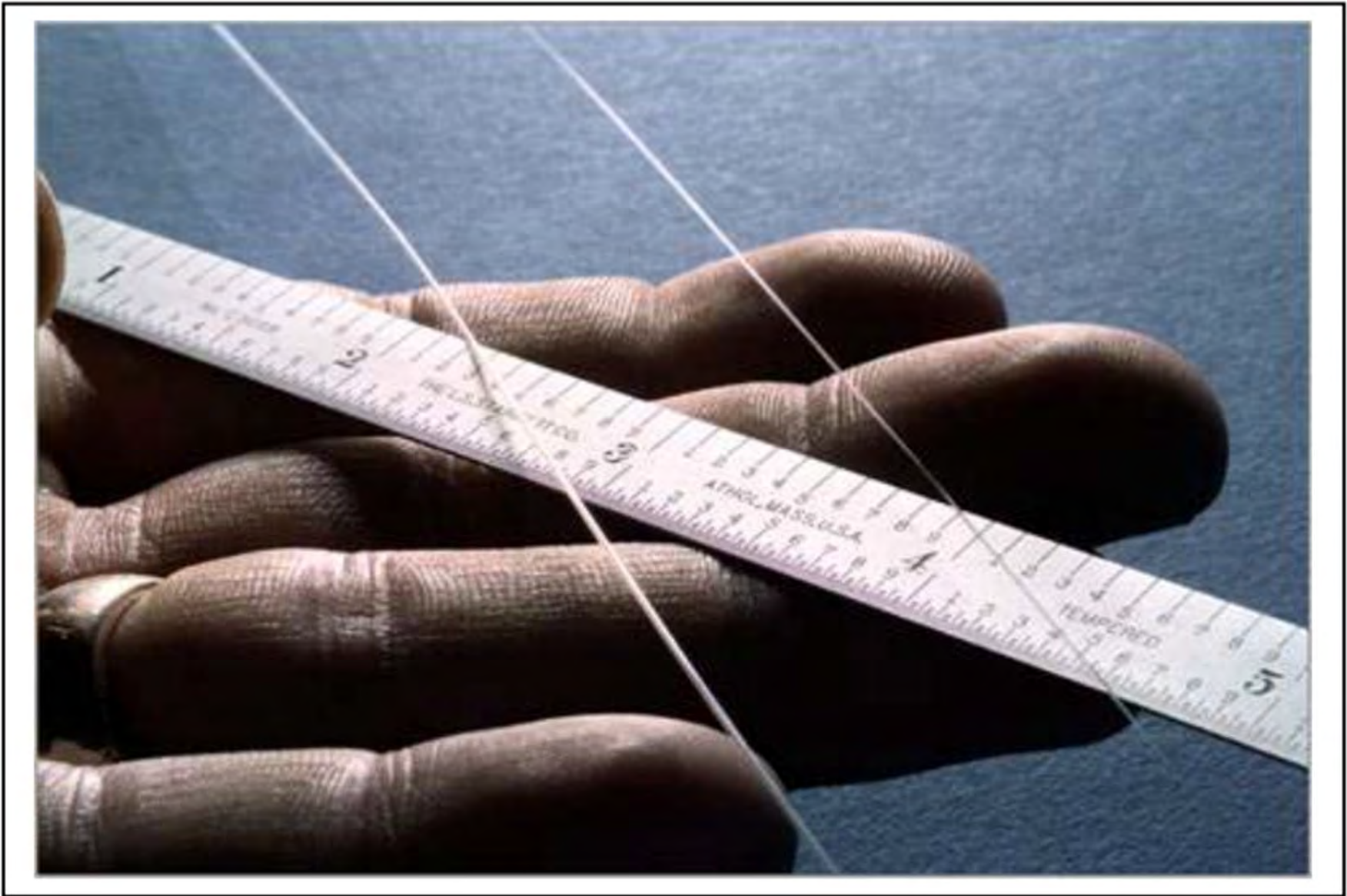
<b>d(0.1):</b> 2.407 um	<b>d(0.5):</b> 54.407 um	<b>d(0.9):</b> 219.190 um
-------------------------	--------------------------	---------------------------



**Figure 9.11:** Particle Size Distribution of geothermal drilling fluid before (top) and after (bottom) treating with micronized cellulose (Rickard *et al.*, 2011b).



**Figure 9.12:** Photograph of two particle ranges of micronized cellulose (Rickard *et al.*, 2011b).



**Figure 9.13:** Typical fibers used for temperature measurement (Finger *et al.*, 2010).

## **APPENDICES**

## APPENDIX A. REFERENCES

- American Petroleum Institute (API), 2011. API SPEC 5CT: Specification for Casing and Tubing. 9<sup>th</sup> Edition, July 2011.
- American Petroleum Institute (API), 2010. API SPEC 6A: ISO 10423:2009 (Modified), Petroleum and Natural Gas Industries - Drilling and Production Equipment - Wellhead and Christmas Tree Equipment. 20<sup>th</sup> Edition, October 2010. Accessed on April 1, 2014 at: <http://www.api.org/certification-programs/api-monogram-program-and-apiqr/~media/files/certification/monogram-apiqr/monogram/program-updates/6a-20th-edition-purch-guidelines-r1-20120429.pdf>.
- American Petroleum Institute (API), 2008. Technical Report on Equations and Calculations for Casing, Tubing, and Line Pipe Used as Casing or Tubing; and Performance Properties Tables for Casing and Tubing. Published December 1, 2008, Seventh Edition, 378 pages.
- American Petroleum Institute (API), 2007a. Recommended Practice for Drilling and Well Servicing Operations Involving Hydrogen Sulfide. API Recommended Practice 49, 3<sup>rd</sup> Edition, May 2001, Reaffirmed March 2007. Accessed on March 1, 2014 at: [file:///D:/Documents/Downloads/API+Drilling-Well+Servicing+H2S\\_49\\_RP.pdf](file:///D:/Documents/Downloads/API+Drilling-Well+Servicing+H2S_49_RP.pdf).
- American Petroleum Institute (API), 2007b. Recommended Practice for Occupational Safety for Oil and Gas Well Drilling and Servicing Operations. API Recommended Practice 54, 3<sup>rd</sup> Edition, August 1999, Reaffirmed March 2007. Accessed on March 1, 2014 at: <http://www.4cornerssafety.com/uploads/clywISBb31iOYendtRsK5JdIbQ5lytDa.pdf>.
- American Petroleum Institute (API), 2005. API SPEC 5CT: Specification 5CT/ISO 11960, Specification for Casing and Tubing. 8<sup>th</sup> Edition, July 2005. Accessed on April 1, 2014 at: <http://www.gaslinepipe.com/wp-content/uploads/2012/08/API-5CT-Specification-for-Casing-and-Tubing.pdf>.
- American Recovery and Reinvestment Act (ARRA), 2014. Blind Geothermal System Exploration in Active Volcanic Environments; Hawai'i and Maui. Funding for Federal

- Contracts, Grants and Loans for February 17, 2009 – Dec 31, 2013: Hawaii (Maui) – Energy Awards – Ormat Technologies, Inc. Profile. Accessed on March 1, 2014 at: <http://www.recovery.gov/arra/Transparency/RecoveryData/pages/RecipientProjectSummary508.aspx?AwardIdSur=93976>.
- Baker Hughes, 2011. Kymera Hybrid Bit Drilled Twice as Fast as Premium Roller-Cone Bits in Iceland: Two Impressive Runs to Total Depth in Basalt. Accessed on March 1, 2014 at: <http://www.bakerhughes.com/news-and-media/resources/case-histories/kymera-hybrid-bit-ch>.
- Battocletti, L., 2005. An Introduction to Geothermal Permitting. Department of Energy: GeoPowering the West Program, 33 pages. Accessed on March 1, 2014 at: [http://www.geothermal-biz.com/Docs/Intro\\_to\\_geo\\_permitting.pdf](http://www.geothermal-biz.com/Docs/Intro_to_geo_permitting.pdf).
- Berard, B., R. Hernandez and H. Nguyen, 2010. Foamed CaP Cement Enables Drilling and Cementing of Geothermal Wells: Case History. *Proceedings World Geothermal Congress, Bali, Indonesia, April 25-29, 2010*, 3 pages.
- Bett, E.K., 2010. Geothermal Well Cementing, Materials and Placement Techniques. Geothermal Training Programme, Orkustofnun, Grensásvegur 9, IS-108, Reykjavík, Iceland, 32 pages.
- Blaydes and Associates, 2007. California Geothermal Energy Collaborative: Expanding California's Confirmed Geothermal Resources Base – Geothermal Permitting Guide. Prepared for the California Energy Commission, 54 pages. Accessed on March 1, 2014 at: <http://energy.ucdavis.edu/files/04-24-2013-CEC-500-2007-027-1.pdf>.
- Bour, D. and B. Rickard, 2000. Application of Foamed Cement on Hawaiian Geothermal Well. *Geothermal Resources Council Transactions*, v. 24, pp. 55-60.
- Bourgoyne, Jr., A.T., K.K. Milheim, M.E. Chenevert and F.S. Young, Jr., 1991. *Applied Drilling Engineering*. Society of Petroleum Engineers, Second Edition, ISBN: 978-1-55563-001-4, 502 pages.



- Boyd, T., 2002. Hawaii and Geothermal – What has been Happening? International Summer School on Direct Application of Geothermal Energy, Volume 23, No. 3, pp. 11-21.
- Busche, S., C. Donnelly, D. Atkins, R. Fields and C. Black, 2013. Renewable Energy Permitting Barriers in Hawai'i: Experience from the Field. National Renewable Energy Laboratory Technical Report No. NREL/TP-7A20-55680, 31 pages.
- California Division of Oil, Gas and Geothermal Resources, 2014. Well Permitting. Accessed on March 1, 2014 at: [http://www.conservation.ca.gov/dog/Pages/WellPermitting.aspx#p\\_a](http://www.conservation.ca.gov/dog/Pages/WellPermitting.aspx#p_a).
- Callis, T., February 7, 2014. Funding OK'd for Gas Monitors, Geothermal Studies. West Hawaii Today. Accessed on March 1, 2014 at: <http://westhawaiiitoday.com/news/local-news/funding-ok-d-gas-monitors-geothermal-studies#>.
- Callis, T., March 23, 2013. Bill to Reinstitute Geothermal Subzones Fails. West Hawaii Today. Accessed on March 1, 2014 at: <http://westhawaiiitoday.com/sections/news/local-news/bill-reinstitute-geothermal-subzones-fails.html>.
- Campbell, A.R. III, M.C. Gardner and GeothermEx, Inc., 1983. Geology and Drilling History of the Ashida #1 Geothermal Test, Opihikao Prospect, Hawaii. Published by GeothermEx, Inc. Accessed on March 1, 2014 at: <http://evols.library.manoa.hawaii.edu/handle/10524/12323>.
- Cannon, E., 1999. Paleoseismic Analysis of the South Flank of Kilauea Volcano, Hawaii. Master's Thesis for the University of California at Berkeley, 81 pages. Accessed on March 1, 2014 at: <http://seismo.berkeley.edu/~burgmann/RESEARCH/HILINA/THESIS/PROSPECT/PROSPECT.html>.
- Chicon, M., March 4, 2013. Dispatchable Geothermal Plant May Shape Future Deals. ALT Energy Stocks. Accessed on March 1, 2014 at: <http://www.altenergystocks.com/archives/2013/03/>.

Clague, D.A. and G.B. Dalrymple, 1987. The Hawaiian-Emperor Volcanic Chain: Part I – Geologic Evolution. In: Decker, R. W., T. L. Wright, and P. H. Stauffer, eds., *Volcanism in Hawaii*, U.S. Geological Survey Professional Paper 1350, pp. 5-54.

Department of Business, Economic Development and Tourism (DBEDT), 2014a. Hawaii Renewable Energy Projects Directory: Geothermal Projects. Accessed on March 1, 2014 at: <https://energy.hawaii.gov/epd/public/energy-project-details.html?rid=c9--34fd0189f21dae1>.

Department of Business, Economic Development and Tourism (DBEDT), 2014b. Renewable Energy Permitting Wizard. Developed under the Hawaii Clean Energy Initiative (HCEI). Accessed on March 1, 2014 at: <http://wizard.hawaii-cleanenergyinitiative.org/>.

Department of Business, Economic Development and Tourism (DBEDT), 2014c. Hawaii State GIS Program. Hawaii State Office of Planning. Accessed on March 1, 2014 at: <http://maps.hawaii.gov/LUDfinder/>.

Department of Business, Economic Development and Tourism (DBEDT), 2013. Guide to Renewable Energy Facility Permits in the State of Hawaii (Version 1). Prepared under the Hawaii Clean Energy Initiative (HCEI), 80 pages. Accessed on March 1, 2014 at: [http://energy.hawaii.gov/wp-content/uploads/2011/12/Permitting-Guide\\_2013\\_VERSION1.pdf](http://energy.hawaii.gov/wp-content/uploads/2011/12/Permitting-Guide_2013_VERSION1.pdf).

Department of Business, Economic Development and Tourism (DBEDT), 2010a. Federal and State Approvals for Geothermal: Hawaii Renewable Energy Permits and Approvals Guidebook. Developed under the Hawaii Clean Energy Initiative (HCEI), 47 pages. Accessed on March 1, 2014 at: [http://energy.hawaii.gov/wp-content/uploads/2011/11/geothermal\\_guidebook.pdf](http://energy.hawaii.gov/wp-content/uploads/2011/11/geothermal_guidebook.pdf).

Department of Business, Economic Development and Tourism (DBEDT), 2010b. Hawaii County Approvals: Hawaii Renewable Energy Permits and Approvals Guidebook. Developed under the Hawaii Clean Energy Initiative (HCEI), 26 pages. Accessed on

March 1, 2014 at: [http://energy.hawaii.gov/wp-content/uploads/2011/11/hawaii\\_guidebook.pdf](http://energy.hawaii.gov/wp-content/uploads/2011/11/hawaii_guidebook.pdf).

Department of Health (DOH), 2013. Regulating Geothermal Air Emissions. Department of Health, Clean Air Branch, State of Hawaii, 2 pages. Accessed on August 1, 2014 at: [http://health.hawaii.gov/cab/files/2013/07/geothermal\\_factsheet2.pdf](http://health.hawaii.gov/cab/files/2013/07/geothermal_factsheet2.pdf).

Department of Health (DOH), 1996. Hawaii Administrative Rules: Title 11, Health Administrative Rules Department of Health, Chapter 46, Community Noise Control (HAR 11-46). State of Hawaii, 32 pages. Accessed on March 1, 2014 at: <http://gen.doh.hawaii.gov/sites/har/AdmRules1/11-46.pdf>.

Department of Land and Natural Resources (DLNR), 2014a. Engineering Division, Geothermal Forms. Accessed on March 1, 2014 at: <https://dlnreng.hawaii.gov/geothermal/forms/>.

Department of Land and Natural Resources (DLNR), 2014b. State Historic Preservation Division, Administrative Rules – HRS Section 343-5. Accessed on March 1, 2014 at: <http://files.hawaii.gov/dlnr/shpd/rules/343-5.pdf>.

Department of Land and Natural Resources (DLNR), 2014c. Engineering Division, Geothermal Exploration Permit Application Form. Accessed on March 1, 2014 at: <http://dlnreng.hawaii.gov/geothermal/wp-content/uploads/sites/17/2014/01/DLNR-Exploration-Permit-Application1.pdf>.

Department of Land and Natural Resources (DLNR), 2014d. Engineering Division, Geothermal Drilling and Well Modification Permit. Accessed on March 1, 2014 at: <http://energy.hawaii.gov/wp-content/uploads/2013/11/DLNR-ENG-Geothermal-Drilling-and-Well-Modification-Permit-9.18.13.pdf>.

Department of Land and Natural Resources (DLNR), 2014e. Engineering Division, Geothermal Drilling and Well Modification Permit Application Form. Accessed on March 1, 2014 at: <http://dlnreng.hawaii.gov/geothermal/wp-content/uploads/sites/17/2014/01/DLNR-Drilling-Permit-Application1.pdf>.

Department of Land and Natural Resources (DLNR), 2014f. Commission on Water Resource Management, Ground Water Forms – Well Abandonment Report. Accessed on March 1, 2014 at: <http://files.hawaii.gov/dlnr/cwrm/forms/WAR.pdf>.

Department of Land and Natural Resources (DLNR), 2012a. Hawaii Revised Statute 182-1: Definitions for Reservation and Disposition of Government Mineral Rights (HRS 182). State of Hawaii, 54 pages. Accessed on March 1, 2014 at: <http://evols.library.manoa.hawaii.edu/bitstream/handle/10524/33591/1981%20-%20Chapter%20183%20Leasing%20and%20Drilling%20of%20GT%20Resources.pdf>.

Department of Land and Natural Resources (DLNR), 2012b. Environmental Impact Statement Preparation Notice for Ulupalukua Geothermal Mining Lease and Geothermal Resource Subzone Modification Application, Island of Maui. State of Hawaii DLNR, 40 pages. Accessed on March 1, 2014 at: <http://www.kulamaui.com/uploads/5/6/3/9/5639079/geothermal-fea-eispn-ulupalakua-feb-23-2012.pdf>.

Department of Land and Natural Resources (DLNR), 2004. Hawaii Well Construction & Pump Installation Standards. Prepared by the Commission on Water Resource Management. Accessed on March 1, 2014 at: <http://files.hawaii.gov/dlnr/cwrm/regulations/hwcpis04.pdf>.

Department of Land and Natural Resources (DLNR), 1981. Hawaii Administrative Rules: Title 13, Department of Land and Natural Resources, Sub-Title 7. Water and Land Development, Chapter 183, Rules on Leasing and Drilling of Geothermal Resources (HAR 13-183). State of Hawaii, 54 pages. Accessed on March 1, 2014 at: <http://evols.library.manoa.hawaii.edu/bitstream/handle/10524/33591/1981%20-%20Chapter%20183%20Leasing%20and%20Drilling%20of%20GT%20Resources.pdf>.

Dick, A., M. Otto, K. Turner and J. Macpherson, 2012. A 300°C Directional Drilling System for EGS Well Installation. Geothermal Resources Council Transactions, v. 36, pp. 393-398.

- Dorian Tool International (Dorian), 2012. High Performance Threading, Grooving and API Cutting Tools and Inserts for CNC and Manual Lathes. 2012 Threading Catalog Inch/Metric. Accessed on April 1, 2014 at: [http://www.doriantool.com/wp-content/uploads/dorian\\_tool\\_threading\\_grooving\\_and\\_api\\_catalog.pdf](http://www.doriantool.com/wp-content/uploads/dorian_tool_threading_grooving_and_api_catalog.pdf).
- Dosch, M.W. and S.F. Hodgson, 1997. Drilling and Operating Oil, Gas, and Geothermal Wells in an H<sub>2</sub>S Environment. California Division of Oil, Gas, and Geothermal Resources (CADOGGR), Publication No. M10, 46 pages.
- Durrand, C.J., M.R. Skeem, R.B. Crockett and D.R. Hall, 2010. Super-hard, Thick, Shaped PDC Cutters for Hard Rock Drilling: Development and Test Results. Proceedings, Thirty-Fifth Workshop on Geothermal Reservoir Engineering, Stanford University, February 1-3, 2010, pp. 454-461.
- Equip Outlet Inc., 2014. API Steel Grade Category and Color. Accessed on April 1, 2014 at: <http://www.equipoutlet.com/api-steel-grade-category/>.
- Finger, J. and D. Blankenship, 2010. Handbook of Best Practices for Geothermal Drilling. Sandia National Laboratories Report SAND2010-6048, 84 pages. Accessed on March 1, 2014 at: <http://www1.eere.energy.gov/geothermal/pdfs/drillinghandbook.pdf>.
- Fitch, D. and S. Matlick, 2008. Gold, Silver and Other Metals in Scale - Puna Geothermal Venture, Hawaii. Geothermal Resource Council *Transactions*, Vol. 32, pp.385-387.
- Fowler, N., D. Thomas and W. Yen, 1980. Geothermal Energy. Hawaii Natural Energy Institute, 66 pages.
- Geothermal Education Office (GEO), 2014. Introduction to Geothermal Energy. Accessed on March 1, 2014 at: <http://geothermal.marin.org/GEOpresentation/>.
- Geothermal Energy Association (GEA), 2013. The Values of Geothermal Energy: A Discussion of the Benefits Geothermal Power Provides to the Future U.S. Power System. Accessed on March 1, 2014 at: <http://www.geothermalenergy.org/pdf/reports/AGuidetoGeothermalEnergyandtheEnvironment10.6.10.pdf>.

- Geothermal Energy Association (GEA), 2007. A Guide to Geothermal Energy and the Environment. Accessed on March 1, 2014 at: <http://www.geo-energy.org/pdf/reports/AGuidetoGeothermalEnergyandtheEnvironment10.6.10.pdf>.
- GeothermEx, Inc., 2005. Assessment of Energy Reserves and Costs of Geothermal Resources in Hawaii. Accessed on March 1, 2014 at: <http://maui-tomorrow.org/pdf/geothermal-assessment-05.pdf>.
- GeothermEx, Inc., 2000. Update of the Statewide Geothermal Resource Assessment of Hawaii. Accessed on March 1, 2014 at: <http://energy.hawaii.gov/wp-content/uploads/2011/10/Update-of-the-Statewide-Geothermal-Resource-Assessment-of-Hawaii.pdf>.
- GeothermEx, Inc., 1994. Annual Report: Geothermal Resource Assessment. Accessed on March 1, 2014 at: <http://evols.library.manoa.hawaii.edu/handle/10524/23406>.
- GeothermEx, Inc., 1992. Annual Report: Geothermal Resource Assessment. Accessed on March 1, 2014 at: <http://evols.library.manoa.hawaii.edu/handle/10524/19340>.
- GeothermEx, Inc., 1989. Reservoir Assessment of the Puna Geothermal Field, Island of Hawaii. Prepared for Ormat Energy Systems, Inc., 104 pages. Accessed on March 1, 2014 at: <http://evols.library.manoa.hawaii.edu/handle/10125/23617>.
- GeothermEx, Inc., 1984. Drilling History and Geology of the Lanipuna No. 6 Geothermal Test, Lanipuna Prospect Hawaii. Accessed on March 1, 2014 at: <http://evols.library.manoa.hawaii.edu/handle/10524/12322>.
- GeothermEx, Inc., 1983. Geology and Drilling History of Lanipuna #1/Sidetrack, Tokyo Lands Prospect, Hawaii. Accessed on March 1, 2014 at: <http://evols.library.manoa.hawaii.edu/handle/10524/12325>.
- GeothermEx, Inc., 1981. Geology and Drilling History of Lanipuna #1 Geothermal Test, Tokyo Lands Prospect, Hawaii. Accessed on March 1, 2014 at: <http://evols.library.manoa.hawaii.edu/handle/10524/12325>.

- Grace, R.D., 2003. Blowout and Well Control Handbook. Published by Gulf Professional Publishing. Accessed on April 1, 2014 at:  
<http://books.google.com/books?id=mYgJQQSyHNQC&printsec=frontcover#v=onepage&q&f=false>.
- Hawaii State Energy Office (HSEO), 2014. Renewable Energy Project Permitting in the State of Hawaii – Guide and Packets. Accessed on March 1, 2014 at:  
<http://energy.hawaii.gov/renewable-energy-project-permitting-in-the-state-of-hawaii>.
- Hawaiian Electric Companies (HECO), 2013. The Renewable Energy Future: The Hawaiian Electric Experience. Electric Power Research Institute Summer Seminar presentation. Accessed on May 1, 2014 at: [http://www.epri.com/About-Us/Documents/Summer%20Seminar%20Presentations/3.5\\_Seu\\_HECO\\_FINAL.pdf](http://www.epri.com/About-Us/Documents/Summer%20Seminar%20Presentations/3.5_Seu_HECO_FINAL.pdf).
- Hernandez, R. and H. Nguyen, 2010. Reverse-Circulation Cementing and Foam Latex Cement Enable Drilling in Lost-Circulation Zones. *Proceedings World Geothermal Congress*, Bali, Indonesia, April 25-29, 2010, 5 pages.
- Hernandez, R., 2009. Reverse-Circulation Cementing and High Performance Geothermal Cements. Geothermal Energy Utilization Associated with Oil & Gas Development - Conference Presentations – Emerging Technologies Forum. Southern Methodist University Geothermal laboratory. Accessed on April 1, 2014 at:  
[http://smu.edu/geothermal/Oil&Gas/2009/Presentations/Hernandez\\_Halliburton\\_09.pdf](http://smu.edu/geothermal/Oil&Gas/2009/Presentations/Hernandez_Halliburton_09.pdf).
- Hofschneider, A., February 26, 2013. Panel OKs Bill Giving Counties More Geothermal Oversight. Honolulu Star Advertiser. Accessed on March 1, 2014 at:  
[http://www.staradvertiser.com/news/20130226\\_Panel\\_OKs\\_bill\\_giving\\_counties\\_more\\_geothermal\\_oversight.html?id=193210931](http://www.staradvertiser.com/news/20130226_Panel_OKs_bill_giving_counties_more_geothermal_oversight.html?id=193210931).
- Hole, H., 2008a. Geothermal Well Design – Casing and Wellhead. Petroleum Engineering Summer School, Workshop #26, Dubrovnik, Croatia, June 9-13, 2008, 7 pages.

- Hole, H., 2008b. Geothermal Deep Well Drilling Practices – An Introduction. Petroleum Engineering Summer School, Workshop #26, Dubrovnik, Croatia, June 9-13, 2008, 6 pages.
- Hole, H., 2008c. Geothermal Well Cementing. Petroleum Engineering Summer School, Workshop #26, Dubrovnik, Croatia, June 9-13, 2008, 6 pages.
- Hosseini-Pourazad, H., 2005. High-Temperature Geothermal Well Design. Geothermal Training Programme, Orkustofnun, Grensasvegur 9, IS-108 Reykjavik, Iceland, 13 pages.
- Huntington, 2014. Seal-Lock APEX Specifications Sheet. Accessed on April 1, 2014 at: [http://www.hunting-intl.com/media/837777/ksl\\_apex\\_spr\\_prnt\\_6-04\\_red.pdf](http://www.hunting-intl.com/media/837777/ksl_apex_spr_prnt_6-04_red.pdf).
- International Organization for Standardization (ISO), 2007. Petroleum and Natural Gas Industries -- Equations and Calculations for the Properties of Casing, Tubing, Drill Pipe and Line Pipe Used as Casing or Tubing. Published by ISO, First Edition, ISO/TR 10400:2007, 229 pages.
- Kaleikini, M., P. Spielman, and T. Buchanan, 2011. Puna Geothermal Venture 8MW Expansion. Geothermal Resources Council Transactions, v. 35, pp. 1,313-1,314.
- Karlsdottir, S.N., I.O. Thorbjornsson and Reykjavik University, 2012. Hydrogen Embrittlement and Corrosion in High Temperature Geothermal Well. NACE International Corrosion Conference and Expo, 2012, 18 pages.
- Keller, G.V., 1974. Drilling at the Summit of Kilauea Volcano. Prepared for the National Science Foundation. Colorado School of Mines, 50 pages.
- Kenedi, C.L., E. Shalev, A. Lucas and P. Malin, 2010. Microseismicity and 3-D Mapping of an Active Geothermal Field, Kilauea Lower East Rift Zone, Puna, Hawaii. *Proceedings World Geothermal Congress, Bali, Indonesia, April 25-29, 2010*, 6 pages.
- Kinslow, R., B. Hass, P. Maddi and P. Bakane, 2012. Development Overview of Geothermal Resources in Kilauea East Rift Zone. *Geo-Heat Center Bulletin*, August 2012, pp. 9-17.



- Kubacki, J., 1984. Geothermal Technology Circular C-108. Prepared for State of Hawaii Department of Land and Natural Resources, 33 pages.
- Kutasov and Eppelbaum, 2012. Cementing of Geothermal Wells – Radius of Thermal Influence. Proceedings, Thirtieth Workshop on Geothermal Reservoir Engineering, Stanford University, Jan 30-Feb 1, 2012, pp. 57-60.
- Lazzarotto, A. and F. Sabatelli, 2005. Technological Developments in Deep Drilling in the Larderello Area. *Proceedings World Geothermal Congress*, Antalya, Turkey, April 24-29, 2005, 6 pages.
- Lentsch, D., A. Savvatis, A. Schubert and W. Schoebel, 2012. Overcoming Drilling Challenges with Rotary Steerable Technology in Deep Geothermal Wells in the Molasse Basin of Southern Germany. *Geothermal Resources Council Transactions*, v. 36, pp. 165-169.
- Lichti, K.A., D.M. Firth and A.D. Karstensen, 2005. Hydrogen Induced Cracking of Low Strength Steels in Geothermal Fluids. *Proceedings World Geothermal Congress*, Antalya, Turkey, April 24-29, 2005, 11 pages.
- Lovekin, J.W., R.C. Henneberger and S.K. Sanyal, 2006. Energy Reserves and Costs of Geothermal Resources in Hawaii. *Geothermal Resources Council Transactions*, v. 30, pp. 891-895.
- Michaux, M., E. Nelson and B. Vidick, 1989. Cement Chemistry and Additives. *Oilfield Review* 1, April 1989, no. 1, pp. 18-25. Accessed on April 1, 2014 at: [http://www.slb.com/~media/Files/resources/oilfield\\_review/ors89/apr89/2\\_cement.pdf](http://www.slb.com/~media/Files/resources/oilfield_review/ors89/apr89/2_cement.pdf).
- Millineaux, D.R., D.W. Peterson and D.R. Crandell, 1987. Volcanic Hazards in the Hawaiian Islands. U.S. Geological Survey Paper 1350 *in* *Volcanism in Hawaii*, pp. 559-621. Accessed on March 1, 2014 at: [http://pubs.usgs.gov/pp/1987/1350/chapters/ch22\\_Mullineaux.pdf](http://pubs.usgs.gov/pp/1987/1350/chapters/ch22_Mullineaux.pdf).
- Mitchell, R.F., 2007. *Petroleum Engineering Handbook, Volume II: Drilling Engineering*. Society of Petroleum Engineers, ISBN: 978-1-55563-114-7, 763 pages.

- Murdock, C., 2010. 6 Massive Secret Operations That Are Hidden All Around You: L.A.'s Urban Oil Rigs. Published August 26, 2010. Accessed on March 1, 2014 at: [http://www.cracked.com/article\\_18717\\_6-massive-secret-operations-that-are-hidden-all-around-you.html](http://www.cracked.com/article_18717_6-massive-secret-operations-that-are-hidden-all-around-you.html).
- Nevada State Legislature, 2013. Nevada Administrative Code Chapter NAC-534A – Geothermal Resources. Accessed on March 1, 2014 at: <http://www.leg.state.nv.us/nac/NAC-534A.html>.
- NACE International, 2001a. Petroleum and Natural Gas Industries - Materials for Use in H<sub>2</sub>S-Containing Environments in oil and gas production, Part 1: General Principles for Selection of Cracking-Resistant Materials. NACE MR0175/ISO 15156-1:2001(E), ISBN 1-57590-1765.
- NACE International, 2001b. Petroleum and Natural Gas Industries - Materials for Use in H<sub>2</sub>S-Containing Environments in oil and gas production, Part 2: Cracking-Resistant Carbon and Low Alloy Steels, and the Use of Cast Irons. NACE MR0175/ISO 15156-2:2001(E).
- NACE International, 2001c. Petroleum and Natural Gas Industries - Materials for Use in H<sub>2</sub>S-Containing Environments in oil and gas production, Part 3: Cracking-Resistant CRAs (Corrosion-Resistant Alloys) and Other Alloys. NACE MR0175/ISO 15156-3:2001(E).
- Ngugi, P.K., 2008. Geothermal Well Drilling. Short Course on Exploration for Geothermal Resources, UNU-GTP and Ken-Gen at Lake Naivasha, Kenya, October 24 – November 17, 2008, 23 pages.
- Ocampo-Diaz, J.D. and J.E. Vaca-Serrano, 2005. Analysis of Workover Techniques in Geothermal Wells of Cerro Prieto Field, Mexico. Proceedings, Thirtieth Workshop on Geothermal Reservoir Engineering, Stanford University, Jan 31-Feb 2, 2005, pp. 122-128.
- Olson, H.J. and J.E. Deymonaz, 1992. The Hawaiian Scientific Observation Hole Program: Preliminary Results and Status Report. School of Ocean and Earth Science and Technology contribution number 2662, 6 pages. Accessed on March 1, 2014 at:

[http://scholarspace.manoa.hawaii.edu/bitstream/handle/10125/21067/HI\\_SOHProg\\_PrelimResultsStatusReport\\_NZ.PDF?sequence=1](http://scholarspace.manoa.hawaii.edu/bitstream/handle/10125/21067/HI_SOHProg_PrelimResultsStatusReport_NZ.PDF?sequence=1).

- Oppelt, J. and J. Lehr, 2012. Innovative Drilling and Completion Concept for Geothermal Applications. Geothermal Resources Council Transactions, v. 36, pp. 109-113.
- Ormat, 2014. Puna Geothermal Venture (PGV), Hawaii, USA. Project website. Accessed on March 1, 2014 at: <http://www.ormat.com/case-studies/puna-geothermal-venture-hawaii>.
- Ormat, 2011. Briefing and Policy Dialogue on Geothermal Energy Potential and Biofuel Energy Potential to Help Meet HCEI Renewable Energy Goals. Presentation accessed on March 1, 2014 at: <http://www.hawaiienergypolicy.hawaii.edu/outreach-communication/energy-briefings/downloads/2011-geothermal-energy-potential-kaleikini.pdf>.
- Orazzini, S., R. Kasirin, G. Ferrari, A. Bertini, I. Bizzocchi, R. Ford, Q. Li and M. Zhang, 2011. New Roller Cone Bit Technology for Geothermal Application Significantly Increases On-Bottom Drilling Hours. Geothermal Resources Council Transactions, v. 35, pp. 215-224.
- Osher, W., February 23, 2012. Geothermal Possibilities Explored at Ulupalakua. Maui Now. Accessed on March 1, 2014 at: <http://mauinow.com/2012/02/23/geothermal-possibilities-explored-at-ulupalakua/>.
- Patterson, R. A., W. L. D'Olier and H. E. Wheeler, 1994a. Hawaii Geothermal Blowout Prevention Manual: Circular C 125. Report by R. A. Patterson and Associates, prepared for State of Hawaii Department of Land and Natural Resources, 66 pages.
- Patterson, R. A., W. L. D'Olier and H. E. Wheeler, 1994b. Hawaii Geothermal Drilling Guide: Circular C 126. Report by R. A. Patterson and Associates, prepared for State of Hawaii Department of Land and Natural Resources, 71 pages.
- Peters, B., A.S. Samuel, W.M. Rickard and M. Sauter, 2013. Reverse Foam Latex Cementing 11-3/4-inch Intermediate Casing in PGV Well KS-15. Geothermal Resources Council Transactions, v. 37, pp. 97-100.

- PICHTR, 2013. Hawaii Geothermal Assessment and Roadmap. Prepared by Pacific International Center for High Technology Research (PICHTR) under contract to Hawaii Natural Energy Institute, University of Hawaii, January 2013. Accessed on March 1, 2014 at:  
<http://www.hnei.hawaii.edu/sites/web41.its.hawaii.edu/www.hnei.hawaii.edu/files/story/2013/03/Geothermal%20Assessment%20and%20Roadmap%20PICHTR%20Jan%202013%20for%20release.pdf>.
- Prevedel, B., J. Binder, R. Jatho, B. Kibellus and L. Wohlgemuth, 2010. Geothermal Drilling Experience with an Innovative Drill Rig. World Geothermal Congress, Bali, Indonesia, April 25-29, 2010, 4 pages.
- PRweb, 2014. Reel-Revolution, Ltd. Begins Building the Revolver(TM) - The World's First Coiled Tubing Drilling Rig That Rotates from Surface. Accessed on March 1, 2014 at:  
<http://www.prweb.com/releases/2008/01/prweb616461.htm>.
- Raymond, D., S. Knudsen, D. Blankenship, S. Bjornstad, J. Barbour and A. Schen, 2012. PDC Bits Outperform Conventional Bit in Geothermal Drilling Project. Geothermal Resources Council Transactions, v. 36, pp. 307-316.
- Reel Revolution Holdings, Ltd., 2014. Company website. Accessed on March 1, 2014 at:  
<http://www.reel-revolution.com/>.
- Richter, L.X., 2014. Hellisheidi geothermal plant starts experimental H2S reinjection. ThinkGeoEnergy. Published April 2, 2014, available on the web at:  
<http://thinkgeoenergy.com/archives/18293>.
- Rickard, B., A. Samuel, C. Lee, P. Spielman, I. Cuadros, J. Long and E. Robert, 2011a. KS 14 Puna Geothermal Venture: Flawless Execution of Aerated Mud Drilling with Mud Motor in Hostile Environment. Geothermal Resources Council Transactions, v. 35, pp. 229-232.
- Rickard, B., A. Samuel, P. Spielman, M. Otto and N. Nickels, 2011b. Successfully Applying Micronized Cellulose to Minimize Lost Circulation on the PUNA Geothermal Venture

- Wells. Presented at the Geothermal Resources Council Transactions, 34<sup>th</sup> Annual Meeting. Accessed on March 1, 2014 at: <http://geothermalresourcegroup.com/wp-content/uploads/2011/03/Successfully-Appling-Micronized-Cellulose-Publication.pdf>.
- Rickard, B., A.S. Samuel, B. Alarcon, A. Bailey and W. Howard, 2011c. Reverse Circulation Cementing of Geothermal Wells: A Comparison of Methods. Geothermal Resources Council Transactions, v. 35, pp. 225-228.
- Schlumberger, 2014a. Oilfield Glossary. Accessed on March 1, 2014 at: <http://www.glossary.oilfield.slb.com/>.
- Schlumberger, 2014b. Neyrfor Turbodrilling Systems. Accessed on March 1, 2014 at: [http://www.slb.com/services/drilling/drilling\\_services\\_systems/directional\\_drilling/neyrf\\_or\\_turbodrills.aspx](http://www.slb.com/services/drilling/drilling_services_systems/directional_drilling/neyrf_or_turbodrills.aspx).
- Schlumberger, 2014c. TDDirect CD Casing-While-Drilling Service. Accessed on March 1, 2014 at: [http://www.slb.com/services/drilling/drilling\\_services\\_systems/casing\\_drilling/directional\\_casing.aspx?t=2](http://www.slb.com/services/drilling/drilling_services_systems/casing_drilling/directional_casing.aspx?t=2).
- Schlumberger, 2014d. Drilling Monitoring. Accessed on March 1, 2014 at: [http://www.slb.com/services/drilling/mud\\_logging/drilling\\_monitoring.aspx](http://www.slb.com/services/drilling/mud_logging/drilling_monitoring.aspx).
- Schlumberger, 2013. Kaldera Bit Drills Geothermal Well Section 25% Farther for Northern California Power Agency. Schlumberger Case Study. Accessed on March 1, 2014 at: [http://www.slb.com/~media/Files/smith/case\\_studies/kaldera\\_california\\_cs.pdf](http://www.slb.com/~media/Files/smith/case_studies/kaldera_california_cs.pdf).
- Schlumberger, 2011. Kaldera Roller Cone Increases On-Bottom Drilling Hours by 37% in Italian Geothermal Application. Schlumberger Case Study. Accessed on March 1, 2014 at: [http://www.slb.com/~media/Files/smith/case\\_studies/kaldera\\_italy\\_cs.pdf](http://www.slb.com/~media/Files/smith/case_studies/kaldera_italy_cs.pdf).
- Sherrod, D. R., J.M. Sinton, S.E. Watkins, and K.M. Brunt, 2007. Geologic Map of the State of Hawai'i. U.S. Geological Survey Open-File Report 2007-1089, version 1.0, 63 pages. Accessed on March 1, 2014 at: <http://pubs.usgs.gov/of/2007/1089/>.

- Smith, D., 2013. State to Plug 20-year-old Geothermal Research Wells. Big Island Now. Published on June 20, 2013, accessed on March 1, 2014 at: <http://bigislandnow.com/2013/06/20/state-to-plug-20-year-old-geothermal-research-wells/>.
- Smith, D., 2012a. Council Approves Ban on Nighttime Well Drilling. Published November 9, 2012, accessed on March 1, 2014 at: <http://bigislandnow.com/2012/11/09/council-approves-ban-on-nighttime-well-drilling/>.
- Smith, D., 2012b. Drilling-Ban Bill Draws Technical and Economic Concerns. Published October 31, 2012, accessed on March 1, 2014 at: <http://bigislandnow.com/2012/10/31/drilling-ban-bill-draws-technical-and-economic-concerns/>.
- Smith, D., 2012c. Council Nixes Environmental Impact Statements for Geothermal Exploration. Published May 21, 2012, accessed on March 1, 2014 at: <http://bigislandnow.com/2012/05/21/council-nixes-environmental-impact-statements-for-geothermal-exploration/>.
- Southon, J.N.A., 2005. Geothermal Well Design, Construction and Failures. *Proceedings World Geothermal Congress, Antalya, Turkey, April 24-29, 2005*, 6 pages.
- Spielman, P., W. Rickard and W. Teplow, 2006. Puna Geothermal Venture, Hawaii – 2005 Drilling Program. *Geothermal Resources Council Transactions*, v. 30, pp. 309-314.
- Standards New Zealand, 1991. Code of Practice for Deep Geothermal Wells. NZS 2403:1991, 96 pages.
- State of Hawaii, 2013. House Bill No. 106: A Bill for an Act Relating to Geothermal Resources. House of Representatives Twenty-Seventh Legislature, 2013, 13 pages.
- Storey, M.L. and E.M. Colvard, 1994. Potential Effects of the Hawaii Geothermal Project on Groundwater Resources on the Island of Hawaii. United States Geological Survey Water

- Resources Investigations Report 94-4028, 41 pages. Accessed on March 1, 2014 at:  
<http://pubs.usgs.gov/wri/1994/4028/report.pdf>.
- Tan, T.T., 1997. Planning of a Slim Well for Geothermal Exploration in Vietnam. Geothermal Training Programme, Orkustofnun, Grensasvegur 9, IS-108 Reykjavik, Iceland, 18 pages.
- Teodoriu, C. and C. Cheuffa, 2011. A Comprehensive Review of Past and Present Drilling Methods with Application to Deep Geothermal Environment. Proceedings, Thirty-Sixth Workshop on Geothermal Reservoir Engineering, Stanford University, Jan 31-Feb 2, 2011, 8 pages.
- Teplow, W., B. Marsh, J. Hulen, P. Spielman, M. Kaleikini, D. Fitch and W. Rickard, 2009. Dacite Melt at the Puna Geothermal Venture Wellfield, Big Island of Hawaii. Geothermal Resources Council Transactions, v. 33, pp. 989-994.
- Thomas, R., D. Whiting, J. Moore, and D. Milner, 1991. Independent Technical Investigation of the Puna Geothermal Venture Unplanned Steam Release, June 12 and 13, 1991, Puna Hawaii. Prepared for the County of Hawaii and the State of Hawaii Department of Land and Natural Resources, 40 pages. Accessed on March 1, 2014 at:  
<http://evols.library.manoa.hawaii.edu/handle/10524/12303>.
- Thomas, D.M., 1986. Geothermal Resources Assessment in Hawaii. Geothermics, v. 15, no. 4, pp. 435-514.
- Thomas, D.M., 1982. A Geochemical Case History of the HGP-A Well 1976-1982. Hawaii Institute of Geophysics Contribution No. 1293, pp. 6. Accessed on March 1, 2014 at:  
<http://scholarspace.manoa.hawaii.edu/bitstream/handle/10125/21042/GeochemCaseHistory.pdf?sequence=1>.
- Thorhallsson, S., 2003. Geothermal Well Operation and Maintenance. Geothermal Training Programme, Reykjavik, Iceland, IGC Short Course, 2003, 23 pages.

- Tilling, R., C. Heliker and D. Swanson, 2010. Eruptions of Hawaiian Volcanoes - Past, Present, and Future. U.S. Geological Survey General Information Product 117, 63 pages. Accessed on March 1, 2014 at: <http://pubs.usgs.gov/gip/117/>.
- True/Mid-Pacific Geothermal Venture, 1982. Revised Environmental Impact Statement for the Kahauale'a Geothermal Project, District of Puna, Island of Hawaii, State of Hawaii. Prepared for the State of Hawaii Department of Land and Natural Resources, 790 pages. Accessed on March 1, 2014 at: <http://evols.library.manoa.hawaii.edu/handle/10524/12283>.
- Tuttle, J.D., S. Reilly, J. Combs, V. Welch and R. Listi, 2010. Managing Geothermal Exploratory Drilling Risks: Drilling Geothermal Exploration and Delineation Wells with Small-Footprint, Highly-Portable Hydraulic Diamond Core Rigs. Geothermal Resources Council Transactions, v. 34, pp. 261-267.
- Ungemach, P., M. Antics, P.E. Danielsen and H. Hole, 2010. Short Course 1: Drilling, Completion and Testing of Geothermal Wells (Lecture Notes). World Geothermal Congress, Bali, Indonesia, April 25-29, 2010, 322 pages.
- University of Hawaii, 2014. Humu'ula Groundwater Research Project (HGRP). Accessed on May 1, 2014 at: <http://hgrp.blogspot.com/p/about.html>.
- U.S. Department of Energy (USDOE), 2014a. Geothermal Regulatory Roadmap. Under the Geothermal Technologies Program in partnership with the National Renewable Energy Laboratory (NREL). Accessed on March 1, 2014 at: [http://en.openei.org/wiki/Hawaii/Geothermal#tab=Regulatory\\_Roadmap](http://en.openei.org/wiki/Hawaii/Geothermal#tab=Regulatory_Roadmap).
- U.S. Department of Energy (USDOE), 2014b. Geothermal Regulatory Roadmap. Under the Geothermal Technologies Program in partnership with the National Renewable Energy Laboratory (NREL). Accessed on March 1, 2014 at: [http://en.openei.org/wiki/GRR/Section\\_20-FD-a\\_-\\_Well\\_Abandonment\\_Process](http://en.openei.org/wiki/GRR/Section_20-FD-a_-_Well_Abandonment_Process)
- U.S. Department of Energy (USDOE), 2014c. Geothermal Technologies Office – Geothermal FAQs. Accessed on March 1, 2014 at:



[https://www1.eere.energy.gov/geothermal/faqs.html#visual\\_impact\\_of\\_geothermal\\_technologies](https://www1.eere.energy.gov/geothermal/faqs.html#visual_impact_of_geothermal_technologies).

U.S. Department of the Interior (USDOl), 2014a. Mammoth Pacific Power Plant. Bureau of Land Management News Bytes Extra, Issue 209. Accessed on March 1, 2014 at: [http://www.blm.gov/ca/news/newsbytes/xtra-05/209-xtra\\_mam\\_geothermal.html](http://www.blm.gov/ca/news/newsbytes/xtra-05/209-xtra_mam_geothermal.html)

U.S. Department of the Interior (USDOl), 2014b. Monthly Report of Geothermal Operations. Accessed on March 1, 2014 at: <http://www.blm.gov/pgdata/etc/medialib/blm/noc/business/eforms.Par.10059.File.dat/3260-005.pdf>.

U.S. Department of the Interior, 1975. Geothermal Resources Operational Order No. 3. Accessed on March 1, 2014 at: <http://www.blm.gov/pgdata/etc/medialib/blm/nv/minerals/geothermal.Par.16792.File.dat/BLM%20GEOTHERMAL%20ORDERS%201970%20Order%203.pdf>.

U.S. Geological Survey, 2014a. Hawaiian Volcano Observatory (HVO) Website: Kīlauea's East Rift Zone (Pu‘u ‘Ō‘ō) Eruption 1983 to present. Accessed on September 14, 2014 at: <http://hvo.wr.usgs.gov/kilauea/summary/main.html>.

U.S. Geological Survey, 2014b. Hawaiian Volcano Observatory (HVO) Website: September 12, 2014 - Kīlauea. Accessed on September 14, 2014 at: <http://hvo.wr.usgs.gov/maps/>.

VAM, 2014. VAM HP Specifications Sheet. VAM Services. Accessed on April 1, 2014 at: [http://www.vamservices.com/products/tubing\\_casing/vamhp.aspx](http://www.vamservices.com/products/tubing_casing/vamhp.aspx).

Whitwam, R., 2014. New ‘extreme’ computer chip can withstand temperatures up to 300 degrees Celsius. Accessed on April 1, 2014 at: <http://www.extremetech.com/extreme/179594-new-extreme-computer-chip-can-withstand-temperatures-up-to-300-degrees-celsius>.

Williamson, D., 2013. Drilling Fluid Basics. Oilfield Review, Spring 2013, v. 25, no.1, pp. 2. Accessed on April 1, 2014 at:

[http://www.slb.com/resources/publications/oilfield\\_review/~media/Files/resources/oilfield\\_review/ors13/spr13/defining\\_fluids.ashx](http://www.slb.com/resources/publications/oilfield_review/~media/Files/resources/oilfield_review/ors13/spr13/defining_fluids.ashx).

Wohletz, K. and G. Heiken, 1992. *Volcanology and Geothermal Energy*. Berkeley: University of California Press, 1992. Accessed on March 1, 2014 at:

<http://ark.cdlib.org/ark:/13030/ft6v19p151/>.

Wygle, P.R., 1995. *Blowout Prevention in California*. Prepared for California Department of Conservation – Division of Oil, Gas and Geothermal Resources, 119 pages.

Yoshihara, T., 1986. The Designation of Geothermal Subzones in Hawaii. *Geothermics*, v. 15, no. 4, pp. 425-430.

## APPENDIX B. GLOSSARY

### A

**actuating system** n.: the array of equipment that stores, pumps and controls the hydraulic fluid needed to operate the components of the BOP stack. Consists of the accumulator, emergency backup system, control manifold, remote operating station(s) and control lines to the wellhead.

**accumulator** n.: on a drilling rig, the storage device for nitrogen-pressurized hydraulic fluid, which is used in closing the blowout preventers.

**aerated drilling fluid** n.: a mixture primarily containing drilling mud or water and compressed air.

**anchor casing** n.: the casing cemented back to surface upon which the permanent wellhead valve or assembly is mounted.

**annular blowout preventer** n.: a large valve, usually installed above the ram preventers, that forms a seal in the annular space between the pipe or kelly and wellbore or, if no pipe is present, on the wellbore itself.

**annulus** n.: 1. the space between outside of drill string and inside of casing or wellbore. 2. the space between outside of casing and the hole.

**API** *abbr.*: American Petroleum Institute.

**APL** *abbr.*: annular pressure loss.

**Auxiliary equipment** n.: the accessories to the BOP stack that assist in preventing or controlling kicks. Consists of the fill-up line, kelly cock(s), safety valve and internal preventer.

### B

**BHA** *abbr.*: bottom hole assembly.

**BHP** *abbr.*: bottom hole pressure.

**BHT** *abbr.*: bottom hole temperature.

**blind ram** n: rams that close against each other to seal off the wellbore completely when there is no pipe in the hole; not intended to seal off against pipe.

**BLM** *abbr.*: Bureau of Land Management.

**BLNR** *abbr.*: Board of Land and Natural Resources (BLNR) for the State of Hawaii. The Board is composed of seven members, one from land district and two at large, and the Chairperson, the executive head of the Department.

**blowout** n: a blowout is an uncontrolled flow of formation steam, fluids or gas from a well bore into the atmosphere or into lower pressure subsurface zones. A blowout occurs when formation pressure exceeds the pressure applied by the column of drilling fluid.

**blowout preventer** n.: the equipment installed at the wellhead to prevent or control the escape of high pressure formation fluids, either in the annular space between the casing and drill pipe or in an open hole (*i.e.*, hole with no drill pipe) during drilling and completion operations. The blowout preventer is located beneath the rig at the surface. See annular blowout preventer and ram blowout preventer.

**BOP** or **BOPE** *abbr.*: blowout prevention equipment or blowout preventer.

**BOP equipment** n.: The entire array of equipment installed at the well to detect and control kicks and prevent blowouts. It includes the BOP stack, its actuating system, kill and choke lines, kelly cocks, safety valves and all other auxiliary equipment and monitoring devices.

**BOP stack** n.: The array of preventers, spools, valves and all other equipment attached to the well head while drilling.

**borehole** n.: the wellbore; the hole made by drilling or boring. See *wellbore*.

**bottom hole assembly** n.: the assembly of heavy drilling tools at the bottom of the drill string; normally includes bit, reamers, stabilizers, drill collars, heavy-weight drill pipe, jars, and other miscellaneous tools.

**bottom hole temperature** n.: The temperature of the fluids at the bottom of the hole. While drilling, these temperatures may be measured by minimum reading temperature devices, which

only record temperatures above a designed minimum, and may not provide an accurate bottom hole temperature. Bottom hole temperature readings should be recorded after a period of fluids circulation at a particular depth in order to stabilize the reading.

## C

**cap rock** n.: relatively impermeable rock overlying a geothermal reservoir that tends to prevent migration of formation fluids out of the reservoir.

**casing** n.: steel pipe, cemented in the wellbore to protect it against external fluids and rock conditions, and to facilitate the reliable and safe production or injection of geothermal fluids.

**CCL** *abbr.*: constant collar locator.

**cellar** n.: a pit in the ground to provide additional height between the rig floor and the wellhead and to accommodate the installation of blowout preventers, rathole, mousehole, and so forth. It also collects drainage water and other fluids for subsequent disposal.

**cementing** n.: the application of a liquid slurry of cement and water to various points inside or outside the casing.

**choke line** n.: the high-pressure piping connecting the BOP outlets or the side of the openings of the mud cross to the choke (control) manifold.

**choke (control) manifold** n.: the system of valves, chokes, piping and gauges used to control the flow from the annulus of the well and regulate the pressures in the working string/annulus flow system.

**CHP** *abbr.*: combined heat and power.

**CO<sub>2</sub>** n.: carbon dioxide; commonly found in geothermal systems almost always as dissolved or free carbon dioxide.

**competent rock** n.: (in wellbores) any rock that stands without support in the drilled wellbore can be described as competent. Beds of ash, or loose volcanic clastics, are vulnerable to failure in open wellbores, and are thus considered to be incompetent rock.

**complete shut off** n.: a full closure and containment of wellbore fluids and pressure at the wellhead.

**conductor** n.: a short string of large-diameter casing used to keep the top of the wellbore open and to provide a means of conveying the up-flowing drilling fluid from the wellbore to the mud pit.

**conductor pipe** n.: the first large diameter pipe set at a shallow depth, usually installed before the rig is mobilized over the well location before drilling commences, used to prevent surface material from cave-in or collapse.

**CSO** *abbr.*: complete shut off.

**CWD** *abbr.*: casing while drilling.

## D

**DBEDT** *abbr.*: Department of Business, Economic Development & Tourism.

**DBR** *abbr.*: damaged beyond repair. Used for defining the condition of drilling equipment or tools.

**diverter** n.: a system used to control well blowouts when drilling at relatively shallow depths by directing the flow away from the rig. The diverter is part of the BOP Stack that includes an annular preventer with a vent line beneath. A valve on the vent line is installed so that it is opened whenever the annular preventer is closed.

**DLNR** *abbr.*: Department of Land and Natural Resources.

**DOA** *abbr.*: Department of Agriculture.

**DOH** *abbr.*: Department of Health.

**DOP** *abbr.*: Department of Planning.

**drilling break** n.: an occasion during drilling when the rate of penetration suddenly increases.

**drill collar** n.: a heavy, thick-walled tube, usually steel, used between the drill pipe and the bit in the drill stem to provide a pendulous effect to the drill stem.

**drilling fluid** n.: a circulating fluid, one function of which is to force cuttings out of the wellbore and to the surface. While a mixture of clay, water, and other chemical additives is the most common drilling fluid, wells can also be drilled using air, gas, or water as the drilling fluid. Also called circulating fluid. See *mud*.

**drilling monitoring** v.: an array of continuous sensing actions which attempt to accurately indicate subsurface conditions as the drill bit is advancing through the rock formation.

**drilling spool** n.: a spacer used as part of the wellhead equipment. It provides room between various wellhead devices (as the blowout preventers) so that devices in the drill stem (as a tool joint) can be suspended in it.

**drill pipe** n.: the heavy seamless tubing used to rotate the bit and circulate the drilling fluid. Joints of pipe are coupled together by means of tool joints.

**drill string** n.: the column, or string, of drill pipe with attached tool joints that transmits fluid and rotational power from the kelly to the drill collars and bit. Often, the term is loosely applied to include both drill pipe and drill collars. Compare drill stem.

**drilling rod** n.: tubulars used to rotate the diamond bit on a core hole. Usage of the Boart Longyear registered trademark sizing names is common, with the largest size being PQ and smallest being AQ (see chart below).

**Hole Size Chart (Based on Boart Longyear\* Product Names)**

SERIES	ROD OD (MM)	ROD ID (MM)	HOLE SIZE (MM)
AQ	44.5	34.9	48
BQ/BRQ	55.6	46.1	60
NQ/NRQ	69.9	60.3	75.7
HQ/HRQ	88.9	77.8	96
PQ/PHD	114.3	101.6	122.6

\*Q® and RQ® are registered trademarks of Boart Longyear

## E

**ECD** *abbr.*: equivalent circulating density. The effective density exerted by the circulating fluid against the formation that takes into account the difference in pressure from the surface to the depth being measured. It is an important parameter in avoiding kicks and losses.

**EGS** *abbr.*: enhanced geothermal system.

**EPA** *abbr.*: US Environmental Protection Agency.

**ESP** *abbr.*: electric submersible pump.

## F

**fill-up line** n.: the line connected to the BOP stack used to add drilling fluid or mud to the wellbore during trips to keep the hole full and maintain the wellbore pressure.

**fish** n.: any part of the drill string, or other tools, accidentally left in the hole.

**flange** n.: a projecting rim or edge (as on pipe, fittings and opening in pumps and vessels), usually drilled with holes to allow bolting to other flanged fittings.

**formation pressure** n.: the force exerted by fluids in a formation, recorded in the hole at the level of the formation with the well shut in. Also called reservoir pressure or shut-in bottom-hole pressure. See *reservoir pressure*.

## G

**geothermal** n.: the thermal energy derived from and stored in the earth.

**GTP** *abbr.*: US DOE Geothermal Technologies Program (recently renamed Geothermal Technologies Office (GTO)).

## H

**H<sub>2</sub>S** n.: hydrogen sulfide; a poisonous gas sometimes found in geothermal drilling.

**Hawaii PUC** *abbr.*: Hawaii Public Utilities Commission.

**HQ** *abbr.*: drilling rod and bit size for core holes. See *drilling rods*.

**HT** *abbr.*: high-temperature.

**HT/HP** *abbr.*: high-temperature/high-pressure.

**hyaloclastites** n.: basaltic lavas which are quickly quenched and fragmented during volcanic eruptions under water or where subaerial flows reach the sea or other bodies of water.



## I

**ID abbr.:** inside or inner diameter. Casing, tubing and drillpipe are commonly described in terms of inside diameter and outside diameter (OD).

**intermediate casing n.:** casing installed where required by subsurface conditions and depth of designed wellbore, to enable the target depth to be reached.

**Internal preventer n.:** a surface-installed working string check valve that tripping back to bottom and reestablishing circulation to control a kick while tripping.

## J

**joint n.:** a single length of drill pipe or of drill collar, casing, or tubing, that has threaded connections at both ends. Several joints, screwed together, constitute a stand of pipe.

## K

**kelly n.:** the heavy steel member, four- or six-sided, suspended from the swivel through the rotary table and connected to the topmost joint of drill pipe to turn the drill stem as the rotary table turns. It has a bored passageway that permits fluid to be circulated into the drill stem and up the annulus, or vice versa.

**kelly cock n.:** a valve installed between the swivel and the kelly. When a high-pressure backflow begins inside the drill stem, the valve is closed to keep pressure off the swivel and rotary hose. See *kelly*.

**kick n.:** an entry of water, gas, or other formation fluid into the wellbore. It occurs because the hydrostatic pressure exerted by the column of drilling fluid is not great enough to overcome the pressure exerted by the fluids in the formation drilled. If prompt action is not taken to control the kick or kill the well, a blowout will occur.

**kill line n.:** a high pressure line that connects the mud pump and the well and through which heavy drilling fluid can be pumped into the well to control a threatened blowout.

## L

**L.C. abbr.:** lost circulation.

**L.C.M. abbr.:** lost circulation material. See *lost circulation material*.

**L.C.Z. abbr.:** lost circulation zone.

**leak off test** n.: a test conducted to determine the strength or fracture pressure of the open formation, usually immediately after drilling below a new casing shoe. The well is shut in and fluid is pumped downhole and at a certain pressure will enter the formation, or leak off. Also known as a pressure integrity test (PIT).

**log** 1. n.: a systematic recording of data, as from the driller's log, mud log, electrical well log, or radioactivity log. Many different logs are run in wells to obtain various characteristics of downhole formations. 2. v.: to record data.

**lost circulation** n.: the loss of quantities of any drilling fluid to a formation, usually in cavernous, fissured, or highly permeable beds, evidenced by the complete or partial failure of the fluid to return to the surface as it is being circulated in the hole. Lost circulation can lead to a kick, which, if not controlled, can lead to a blowout.

**lost circulation material** n.: the collective term for the solid substances added to drilling fluids when drilling fluids are being lost to the formations downhole. Lost-circulation materials may consist of fibrous (*e.g.*, mineral fiber), flaky (*e.g.*, mica flakes) or granular (*e.g.*, wood, nut hulls).

**LOT** *abbr.:* leak off test.

## M

**manifold** n.: an accessory system of piping to a main piping system (or another conductor) that serves to divide a flow into several parts, to combine several flows into one, or to reroute a flow to anyone of several possible destinations.

**MD** *abbr.:* measured depth. The depth of the wellbore measured along the path drilled.

**Measurement While Drilling (MWD)** n.: mud pulse telemetry system used to take real-time measurements of the inclination and magnetic direction of the bottom of the wellbore during drilling operations.

**mud** n.: the liquid circulated through the wellbore during rotary drilling and workover operations. In addition to its function of bringing cuttings to the surface, drilling mud cools and lubricates the bit and drill stem, protects against blowouts by holding back subsurface pressures, and prevent loss of fluids to the formation. Although it was originally a suspension of earth solids (especially clays) in water, the mud used in modern drilling operations is a more complex, three-phase mixture of liquids, reactive solids, and inert solids. The liquid phase may be fresh water, and may contain one or more conditioners. See *drilling fluid*.

**mud logging** n.: the recording of information derived from examination and analysis of formation cuttings suspended in the mud or drilling fluid, and circulated out of the hole. A portion of the mud is diverted through a gas-detecting device. Cuttings brought up by the mud are examined to detect potential geothermal production intervals. Mud logging is often carried out in a portable laboratory set up near the well.

**mud pits** n. pl.: a series of open tanks, usually made of steel plates, through which the drilling mud is cycled to allow sand and sediments to settle out. Additives are mixed with the mud in the pits, and the fluid is temporarily stored there before being pumped back into the well. Modern rotary drilling rigs are generally provided with three or more pits, usually fabricated steel tanks fitted with built-in piping, valves, and mud agitators. Mud pits are also called shaker pits, settling pits, and suction pits, depending on their main purpose. Also called mud tanks.

**mud weight** n.: a measure of the density of a drilling fluid expressed as pounds per gallon (ppg), pounds per cubic foot (lb/ft<sup>3</sup>), or kilograms per cubic meter (kg/m<sup>3</sup>). Mud weight is directly related to the amount of pressure the column of drilling mud exerts at the bottom of the hole.

**MWD** *abbr.* Measurement While Drilling

## N

**NCG** *abbr.*: non-condensable gas(es).

**NMFS** *abbr.*: National Marine Fisheries Service.

**NOAA** *abbr.*: National Oceanic and Atmospheric Administration.

**NQ** *abbr.*: drilling rod and bit size for core holes. See *drilling rods*.

## O

**OD** *abbr.*: outside or outer diameter. Casing, tubing and drillpipe are commonly described in terms of inside diameter (ID) and outside diameter.

**ORC** *abbr.*: organic Rankine cycle. A thermodynamic process used to transfer heat to a fluid at a constant pressure enabling recovery from lower temperature resources.

## P

**P&A** *abbr.*: plugged and abandoned.

**PDC** *abbr.*: polycrystalline diamond compact.

**permeability** n.: 1. a measure of the ease with which fluids can flow through a porous rock. 2. the fluid conductivity of a porous medium. 3. the ability of a fluid to flow within the interconnected network of a porous medium.

**PHPA** *abbr.*: partially hydrolyzed polyacrylamide. A powder used as a mud additive to stabilize a wellbore.

**pipe ram** n.: a sealing component for a blowout preventer that closes the annular space between the pipe and the blowout preventer or wellhead. See ram and ram blowout preventer.

**pit-level indicator** n.: one of a series of devices that continuously monitors the level of the drilling mud in the mud pits. The indicator usually consists of float devices in the mud pits that sense the mud level and transmit data to a recording and alarm device (called pit-volume recorder) mounted near the driller's position on the rig floor. If the mud level drops too low or rises too high, the alarm sounds to warn the driller that action may be necessary to control lost circulation or to prevent a blowout.

**polycrystalline diamond compact (PDC)** n.: a disk-shaped cutting element of a bit, composed of a tungsten carbide substrate that supports a disk of diamond grains sintered together, usually with cobalt.

**pounds per gallon** n.: a measure of the density of a fluid (as drilling mud).

**pounds per square inch** n.: a measure of the pressure of a fluid (as drilling mud) in terms of force per unit area.

**ppg** *abbr.*: pounds per gallon.

**ppm** *abbr.*: parts per million.

**pressure** n.: the force that a fluid (liquid or gas) exerts when it is in some way confined within a vessel, pipe, hole in the ground, and so forth, such as that exerted against the inner wall of a tank or that exerted on the bottom of the wellbore by drilling mud. Pressure is often expressed in terms of force per unit of area, as pounds per square inch (psi).

**production casing** n.: the deepest string of casing fully cemented back to the surface.

**production liner** n.: a casing string installed to protect the openhole section of the well from the corrosive and/or erosional effects of the producing fluid or steam.

**psi** *abbr.*: pounds per square inch.

**PWD** *abbr.*: Public Works Department.

## Q

**quench** v.: the injection of cool fluids or water into the wellbore to condense steam or to reduce the temperature of the wellbore, surrounding formation and any formation fluids.

## R

**ram** n.: the closing and sealing component on a blowout preventer. One of three types - blind, pipe, or shear - may be installed in several preventers mounted in a stack on top of the wellbore. Blind rams, when closed, form a seal on a hole that has no drill pipe in it; pipe rams, when closed, seal around the pipe; shear rams cut through drill pipe and then form a seal.

**ram blowout preventer** n.: a blowout preventer that uses rams to seal off pressure on a drillpipe, casing annulus or an open hole. It is also called a ram preventer. See *blowout preventer* and *ram*.

**RC** *abbr.*: roller cone.

**reservoir pressure** n.: the pressure in a reservoir under normal conditions.

**ROP** *abbr.*: rate of penetration.

**rotating head** n.: a rotating pressure sealing device used when performing well operations with air, gas or foam as a circulating fluid, or in any other conditions that may result in underbalanced wellbore conditions.

**RPM** *abbr.*: revolutions per minute.

## S

**safety valve** n.: a fully opening valve positioned on the rig floor, fitted with connections or adaptors to fit the working pipe in use, which is used to close off the inside of the working string to prevent internal flow.

**slotted liner** n.: casing pipe having perforations to allow for the passing through of fluids or steam either during production or injection. Also installed in the openhole section of the well to prevent cave-in or collapse.

**shear rams** n.: rams with a built in cutting blade which will shear any pipe in the hole to form a complete seal against itself.

**slurry** n.: a semiliquid cement mixture, typically composed of fine particles cement and other additives such as bentonite or wood calcium chloride (CaCl) suspended in water.

**sour gas** n.: natural gas or any other gas containing significant amounts of hydrogen sulfide (H<sub>2</sub>S). See H<sub>2</sub>S.

**ST** *abbr.*: sidetrack.

**sulfide stress corrosion or cracking (SSC)** n.: form of corrosion that may occur due to tensile stress and environments involving hydrogen sulphide in an aqueous phase. Low pH greatly accelerates material failure.

**surface casing** n.: the first string of steel pipe (after the conductor) that is set in a well, varying in length from a few hundred to several thousand feet, and cemented back to surface.

**survey** n.: a continuous wellbore measurement of a parameter such as pressure or temperature.

## T

**TCI** *abbr.*: tungsten carbide insert.

**TD** *abbr.*: total depth.

**TDS** *abbr.*: total dissolved solids.

**TDT** *abbr.*: tracer-dilution testing.

**TFT** *abbr.*: tracer flow testing.

**top job** n.: casing cement which is placed from the top, rather than being displaced through the casing shoe. It is either pumped under pressure directly into the top of the annulus, or pumped through a tremie line for shallower placement in the annulus.

**total dissolved solids (TDS)** n.: a measure of the minerals dissolved in a fluid, usually applied to produced brine from a geothermal well.

**trip** 1. n.: the operation of hoisting the drill stem from and returning it to the wellbore. 2. v.: shortened form of make a trip.

**TVD** *abbr.*: true vertical depth. The true depth measured vertically from the surface.

## U

**USACE** *abbr.*: US Army Corps of Engineers.

**USDA** *abbr.*: US Department of Agriculture.

**USDOE** *abbr.*: US Department of Energy.

**USDOI** *abbr.*: US Department of Interior. Includes the Bureau of Land Management (BLM).

**USFWS** *abbr.*: US Fish and Wildlife Service.

## W

**wellbore** n.: a borehole; the hole drilled by the bit. A wellbore may have casing in it or may be open (*i.e.*, uncased), or a portion of it may be cased and a portion of it may be open. Also called borehole or hole.

**wellhead** 1. n.: the equipment installed at the surface of the wellbore. A wellhead includes such equipment as the casing head and tubing head. 2. adj.: pertaining to the wellhead (as wellhead pressure).

**WHP** *abbr.*: wellhead pressure.


**WO** *abbr.*: weight on bit.

**workover** v.: the process of performing major maintenance or remedial treatments on a well.




## APPENDIX C. RENEWABLE ENERGY PERMIT CHECKLISTS (FEDERAL, STATE AND COUNTY)


**Table 2-4. Checklist of Federal Renewable Energy Approvals**

	Possible Activity to be Performed	Permit Packet Number	Department	Name of Permit
<b>Federal Environmental Permits and Reviews</b>				
	<p>Any of the following activities trigger this permit:</p> <p>(1) work in “waters of the US”, including placement of structures. “Waters of the US” encompass a range of surface water features, including wetlands, lakes, intermittent streams, rivers, and ocean areas;</p> <p>(2) discharge of dredged or fill material into wetlands or other types of surface waters; or</p> <p>(3) transport dredged material for ocean disposal.</p> <p>If other federal agencies are also involved because of the location or type of renewable energy project (e.g., FERC, NOAA, BOEM), the federal agencies will need to coordinate their roles and responsibilities.</p>	F-01	USACE	Department of the Army (DA) Permit (includes Clean Water Act Section 404 approval, Rivers and Harbors Act Section 10 approval, and Marine Protection, Research and Sanctuaries Act Section 103 approval) 401 APPLY HERE?
	This permit is triggered by the construction or modification of a bridge (including causeway) across “navigable waters of the United States.” Jurisdiction is typically coordinated with the USACE.	F-02	USCG	Bridge Permit, Rivers and Harbors Act Section 9 Approval
	This permit and notice are triggered by any activity in “navigable waters of the U.S.” that may impact marine transportation, harbor activities and the environment. This permit and notice process would typically start a few months before marine construction starts.	F-03	USCG	Marine and Harbor Activities Notice
	To assess the environmental effect of projects performed by federal agencies, or projects requiring a federal permit, receiving federal funds, or located on federal land. If there is federal involvement in the project through funding or other mechanism, NEPA compliance is required.	F-04	CEQ	National Environmental Policy Act (NEPA) compliance, or EIS Law
	To perform subsurface injection of waste fluids below, into and above underground sources of drinking water. “Injection” includes seeping, flowing, leaching, and pumping, with or without added pressure. This permit may be required where groundwater injection is proposed for waste discharge.	F-05	EPA	Groundwater & Drinking Water Permit
	The intent of this process is to assure that high quality air is maintained in our National Parks. To meet the federal and state regulation National Park Service Federal Land Manager (FLM) consultation requirements regarding possible sources of air pollution that may affect Class I areas (generally within 300 km of a Class I area) or are within close proximity to Class II areas.	F-06	NPS	National Park Service, Air Resources Division


**Table 2-4. Checklist of Federal Renewable Energy Approvals (continued)**

	Possible Activity to be Performed	Permit Packet Number	Department	Name of Permit
	To conduct an activity that might “take” (harass, harm, pursue, hunt, kill, trap, capture, or collect) any marine mammal, marine or anadromous fish, or other living marine resources with federal nexus. Endangered Species Act (ESA) listed Essential Fish Habitat (EFH) consultations should also occur during this process.	F-07	NOAA	Incidental Take Statement, Endangered Species Act Section 7 (a)(2)
	To conduct an activity that might “take” (harass, harm, pursue, hunt, shoot, wound, kill, trap, capture, or collect, or to attempt to engage in any such conduct) an Endangered Species Act (ESA) listed marine mammal, marine or anadromous fish, or other living marine resources with no federal nexus.	F-08	NOAA	Incidental Take Permit, Endangered Species Act Section 10(a)(1)(B)
	To conduct an activity that might “take” small numbers of marine mammals by U.S. citizens who engage in a specified activity (other than commercial fishing) within a specified geographic region. The LOA or IHA includes harassment of marine mammals by noise.	F-09	NOAA	Letter of Authorization (LOA) or Incidental Harassment Authorization (IHA)
	To conduct an activity that might “take” (harass, harm, pursue, hunt, shoot, wound, kill, trap, capture, or collect, or to attempt to engage in any such conduct) an Endangered Species Act (ESA) listed terrestrial and freshwater aquatic species with federal nexus.	F-10	USFWS	Incidental Take Statement, Endangered Species Act Section 7 (a)(2)
	To conduct an activity that might “take” (harass, harm, pursue, hunt, shoot, wound, kill, trap, capture, or collect, or to attempt to engage in any such conduct) an Endangered Species Act (ESA) listed terrestrial and freshwater aquatic species with no federal nexus.	F-11	USFWS	Incidental Take Permit, Endangered Species Act Section 10(a)(1)(B)
	To construct structures and perform activities that could impact cultural, historic, or archeological resources as defined in Section 106 of the National Historic Preservation Act.	No Packet	DLNR-SHPD	Historic and Archeological Resource Protection, Section 106 Process
	To construct structures and perform activities that would impact properties funded by the Land and Water Conservation Fund.	No Packet	NPS	Section 6(f), Land and Water Conservation Fund Act
<b>Federal Land Use Permits</b>				
	To construct or alter any structure more than 200 feet in height above the ground level at its site (additional requirements exist for structures closer than 20,000 feet to the nearest point of the nearest runway of specified airports).	F-12	FAA	Construction in Airspace
	To allow renewable energy of existing facilities on the Outer Continental Shelf (OCS).	F-13	BOEM	Outer Continental Shelf (OCS) Renewable Energy Project Leases, Rights-of-Use and Easement, and Rights-of-Way


**Table 2-4. Checklist of Federal Renewable Energy Approvals (continued)**

	Possible Activity to be Performed	Permit Packet Number	Department	Name of Permit
<b>Federal Utility Permits</b>				
	To construct, operate, or maintain a non-federal hydroelectric project that is or would be (a) located in the navigable waters of the U.S.; (b) occupy U.S. lands; (c) utilize surplus water or water power from a U.S. government dam; or (d) be located on a stream over which Congress has Commerce Clause jurisdiction, where project construction or expansion occurred on or after August 26, 1935, and the project affects the interests of interstate or foreign commerce.	F-14	FERC	Hydroelectric License
	To obtain authorization for hydrokinetic pilot project activities on the Outer Continental Shelf (OCS).	F-15	FERC	Hydrokinetic Pilot Project License


**Table 2-5. Checklist of State Renewable Energy Approvals**

	Possible Activity to be Performed	Permit Packet Number	Department	Name of Permit
<b>State of Hawai'i Environmental Permits and Reviews</b>				
	To perform federal actions (including activities performed by a non-federal entity requiring federal permits, licenses or other forms of federal authorization) that has a reasonably foreseeable effect on any land or water use or natural resource of the coastal zone, and/or is on the outer continental shelf.	S-01	OP	Coastal Zone Management Federal Consistency Review
	To apply for agricultural burning (i.e. the use of open outdoor fires in agricultural operations, forest management, or range improvement).	S-02	DOH	Agricultural Burning
	To construct, reconstruct, modify, or operate a stationary air pollution source.	S-03	DOH	Air Pollution Control Permit (Covered Source Permit and Noncovered Source Permit)
	To build a treatment works which complies with the basic wastewater treatment criteria set in Hawai'i Administrative Rules (HAR) §11-62-26, and treatment works from which sludge is not covered by HAR §11-62-50(d) and HAR §11-62-40(a) 2 through 4.	S-04	DOH	Biosolids Treatment Works Permit—Notice of Intent


**Table 2-5. Checklist of State Renewable Energy Approvals (continued)**

	Possible Activity to be Performed	Permit Packet Number	Department	Name of Permit
	To propose the use of state or county lands, or lands within conservation districts, shoreline area, historic sites, or in the Waikiki Special District; to propose amendments to county general plans; or to propose a wastewater system, waste-to-energy facility, landfill, oil refinery, or power generating facility according to Hawai'i Revised Statutes (HRS) Chapter 343-5.	S-05	DOH	Environmental Impact Statement/ Environmental Assessment
	To own or operate a facility or enterprise that engages in the treatment, storage, or disposal of hazardous waste as defined by HAR §11-261-3.	S-06	DOH	Hazardous Waste TSD
	To apply to build, run, or operate an individual wastewater treatment facility.	S-07	DOH	Individual Wastewater System Permit
	To engage in any activity that might materially alter the surrounding water supply, or to operate a facility that creates a liquid discharge into state or local water supplies.	S-08	DOH	National Pollutant Discharge Elimination System Permit (Operation)
	To establish, operate, or modify any solid waste management facility.	S-09	DOH	Solid Waste Management by Rule
	To own or operate a facility in the state that stores, uses or manufactures any hazardous substance that is equal to or exceeds reporting thresholds as established by Hawai'i Chemical Inventory Form (HCIF) according to Hawai'i Administrative Rules (HAR) 128E-6, and the EPA's federal regulations for chemicals.	S-10	DOH	Superfund Amendment & Reauthorization Act (SARA) Reporting
	To apply to construct, operate, or modify an underground injection well.	S-11	DOH	Underground Injection Control
	To construct, install, or operate an underground storage tank or tank system.	S-12	DOH	Underground Storage Tank
	To discharge water pollutant in excess of applicable standards according to Hawai'i Administrative Rules 11-62.	S-13	DOH	Variance from Pollution Control
	To assimilate domestic, agricultural, and industrial waste discharges into the natural environment in a manner that achieves the highest attainable level of water quality as described in Hawai'i Administrative Rules §11-54.	S-14	DOH	Zone of Mixing Permit
	To allow the incidental take of endangered or threatened species while carrying out an otherwise lawful activity. "Take" is defined as to: harass, harm, pursue, hunt, shoot, wound, kill, trap, capture, or collect any threatened or endangered species, including plants, animals, birds, fresh and marine water species.	S-15	DLNR	Incidental Take License and Habitat Conservation Plan
	To conduct trials involving the evaluation of pesticides to determine the scope and limitations of its usefulness and the effect of its use on humans and the environment.	S-16	DOA	Pesticides Experimental Use Permit


**Table 2-5. Checklist of State Renewable Energy Approvals (continued)**

	Possible Activity to be Performed	Permit Packet Number	Department	Name of Permit
	To use Restricted-Use Pesticides (those that have a greater chance of impacting the environment or human health).	S-17	DOA	Pesticides Applicator Certification
	To engage in the construction, expansion, or demolition of buildings, houses, bridges, roadway (including improvements), utilities, reservoirs or any other activity causing excess noise in the community <u>within</u> the standard business hours.	S-18	DOH	Noise Permit
	To engage in the construction, expansion, or demolition of buildings, houses, bridges, roadway (including improvements), utilities, reservoirs or any other activity causing excess noise in the community <u>outside</u> the standard business hours.	No Packet	DOH	Noise Variance
	To show that construction runoff on renewable energy construction site will not violate applicable water quality standards.	S-19	DOH	Section 401 Water Quality Certification Permit
	To install, construct, reconstruct, or relate any boiler, pressure vessel or pressure system.	S-20	DLIR	Boiler / Pressure Vessel Permit
	To install or alter elevators, dumbwaiters, escalators, moving walks, manlifts, and personnel hoists.	S-21	DLIR	Elevator and Kindred Equipment Permit
	To construct, enlarge, repair, alter, or remove a (dam)s.	S-22	DLNR	Dams and Reservoirs Permit
	To develop geothermal and cable system projects.	S-23	DLNR	Geothermal and Cable System Development Permitting
	To conduct any exploration activity (including geophysical operations, drilling of shallow temperature test holes less than 500 feet in depth unless deeper drilling is allowed by the board, construction of roads and trails, and vehicle travel) on state or reserved lands for evidence of geothermal resources.	S-24	DLNR	Geothermal Exploration Permit
	To access or enter into forest reserves.	No Packet	DLNR	Right of Entry/Access Permit
	To drill wells for the irrigation of water.	S-25	DLIR	Well Construction and Pump Installation Permit
	To perform construction to cross or enter the State Energy Corridor on O’ahu. The State Energy Corridor is a pipeline extending from the refineries in Campbell Industrial Park to Honolulu Harbor.	S-26	DOT	Construction to Cross or Enter the State Energy Corridor
	To perform work upon a state highway, such as utility service connections, overhead/ underground utility crossings, soil borings, etc.	S-27	DOT	Construction Upon a State Highway

**Table 2-5. Checklist of State Renewable Energy Approvals (continued)**

	Possible Activity to be Performed	Permit Packet Number	Department	Name of Permit
	To use vehicles or transport loads of a size or weight that exceeds the maximum dimensions established by Hawai'i Administrative Rules 19-104.	S-28	DOT	Oversize and Overweight Vehicles
	To park on a restricted section of highway under state jurisdiction for construction adjacent to and within the highway right-of-way.	S-29	DOT	Use and Occupancy Agreement (Lane Use Permit for Construction Work)
	To perform any dredging, filling, installation of buoys, or erecting of any construction within commercial harbors and entrance channels belonging to or controlled by the State.	S-30	DOT	Work in Ocean Waters of the State
	To perform activities in the development or redevelopment of the makai or mauka areas of the Kaka`ako District	S-31	HCDA	Kakaako Development Permit
	To amend a land use district boundary in order to development a renewable energy resource or technology on that land.	S-32	LUC	District Boundary Amendment
	To develop on over 15 acres of agricultural and/or rural district lands for "unusual and reasonable" uses; or to develop any number of acres on lands designated as "important agricultural lands."	S-33	LUC	Special Use Permit—over 15 acres
	To develop in special management areas as defined in the state (including Kaka`ako Industrial Area on O`ahu), as well as build structures and perform activities within shoreline setback areas of community development districts.	S-34	LUC	Special Management Area Use Permit
	To enter a closed, restricted watershed.	S-35	DLNR	Closed Watershed Entry
	To apply for a land use in the State Land Use Conservation District.	S-36	DLNR	Conservation District Use Permit
	To conduct marine activities (including ocean thermal energy conversion; mariculture; and other energy or water, research, scientific, and educational activities) in, on, or under state marine waters or submerged lands.	S-37	DLNR	Conservation District Use Permit—State Marine Waters/Ocean Waters Construction Permit (OWCP)
	To drill, modify, modify use, or abandon wells.	S-38	DLNR	Well Construction and Modification Permit
	To request for state lands for access, utility or other easements to private property; purchase of remnant; direct lease; and/or land license.	S-39	DLNR	Easement for Use of State Land
	To conduct activities otherwise prohibited in state natural area reserves, including research, collection of samples, education, management, or other generally prohibited activity.	S-40	DLNR	Forest Reserve Special Use Permit


**Table 2-5. Checklist of State Renewable Energy Approvals (continued)**

	Possible Activity to be Performed	Permit Packet Number	Department	Name of Permit
	To conduct geothermal development and/or exploration activities.	No Packet	DLNR	Geothermal Drilling Permits
	To lease geothermal resources for commercial production.	No Packet	DLNR	Geothermal Mining Lease
	To establish new uses of ground water (as well as modifications of existing ground water use permits) in a designated ground water management area.	S-42	DLNR	Groundwater Control Area
	To construct structures and perform activities that could impact a historic property, aviation artifact, or a burial site as defined in Section 6E-8 of Hawai'i Revised Statutes (HRS). After an assessment, develop and execute plans to avoid, minimize, or mitigate adverse effects to the historic properties. (Please note that if a Native Hawaiian burial site is affected, the appropriate Island Burial Council must be consulted during this process.)	S-43	DLNR	Historic Preservation Review, HRS Chapter 6E
	To assess effects of a renewable energy project on significant historic properties, and then develop and execute plans to avoid, minimize, or mitigate adverse effects to the historic properties.	S-44	DLNR	Historic Sites Review
	To conduct research / activities within the Natural Area Reserve System (NARS).	S-45	DLNR	Natural Area Reserves Permit
	To improve and/or divert existing streams on renewable energy project property.	S-46	DLNR	Stream Channel Alteration
	To enter a prohibited area in a wildlife sanctuary, and/or collect data.	S-47	DLNR	Wildlife Sanctuary Entry
	To enter or access into restricted forest reserve(s).	S-48	DLNR	Forest Reserve Entry/Access Permit
	To commence business as a public utility in the State of Hawai'i.	S-49	PUC	Certificate of Public Convenience and Necessity
	To conduct activities that would require the utility to purchase power from an independent power producer.	S-50	PUC	Power Purchase Agreement Approval
	To interconnect a proposed renewable energy project to the existing grid, where new transmission lines are required.	S-51	PUC	Transmission Line Approval


Source: Renewable Energy Project Permitting in the State of Hawaii

Website: [://energy.hawaii.gov/developer-investor/renewable-energy-project-permitting-in-the-state-of-](http://energy.hawaii.gov/developer-investor/renewable-energy-project-permitting-in-the-state-of-)


**Table 3-4. Hawai'i County Activity Checklist**

	Possible Activity to be Performed	Permit Packet Number	Department	Name of Permit
<b>Environmental Permits</b>				
	To construct structures and perform activities in the "Shoreline Setback Area" as defined in Hawai'i County Planning Department Rules of Practice and Procedure, Rule 11 and Hawai'i County Planning Commission Rules of Practice and Procedure, Rule 8.	H-1	PD	Certified Shoreline/Shoreline Setback Variance
	To perform any development, structure, or activity within the Special Management Area (SMA) as defined in the Hawai'i County Planning Commission Rules of Practice and Procedure, Rule 9.	H-2	PD	Special Management Area Use Permit (Assessment and Application)
<b>Construction and Operation Permits</b>				
	To erect a new building or structure.	H-3	PWD	Building Permit
	To perform any type of plumbing work.	H-4	PWD	Plumbing Application
	To perform any construction activity in or near a flood zone.	H-5	PWD	Flood Zone Designation Form
	To perform any one of the following activities that (1) exceeds 100 cubic yards of excavation or fill; (2) a vertical height of excavation or fill measured at its highest point that exceeds 5 feet; or (3) when the general and localized drainage pattern with respect to abutting property lines is altered.	H-6	PWD	Grading Permit
	To clear areas that exceed one acre (43,560 square feet).	H-7	PWD	Grubbing Permit
	To work within the County right-of-way before construction; i.e., landscaping, utility lines, driveways, sidewalk repair, and construction.	H-8	PWD	Permit to Work Within the County-Right-of-Way
	To place a private waterline within the County right-of-way.	H-9	PWD	Private Waterline Installation
	To store material exceeding 500 cubic yards.	H-10	PWD	Stockpiling Permit
	To request a variance from provisions and conditions found in Hawai'i County Code Chapter 22 concerning county streets.	H-11	PWD	Variance Application for County Streets




	Possible Activity to be Performed	Permit Packet Number	Department	Name of Permit
<b>Land Use Permits</b>				
	To develop within the agricultural zoning districts and establish an Agricultural Project District (APD). An APD requires no less than 5 acres of land and is defined in Hawai'i County Code, Chapter 25, Article 6. (In lieu of specific land designations, this permit provides a flexible and creative planning approach in the location of specific types of agricultural uses and variations in lot sizes.)	H-12	PD	Agricultural Project District Application
	To allow development certain districts in order to ensure conformance with the Hawai'i County General Plan, to assure that the intent and purpose of Hawai'i County Code Chapter 25 are carried out, and to ensure pertinent conditions of previous approvals related to the development have been implemented.	H-13	PD	Plan Approval
	To construct or perform activities that would require the granting of provisions in the zoning requirements, Hawai'i County Code Chapter 25; provided that a variance shall not allow the introduction of a use not otherwise permitted within the district; and provided further that a variance shall not primarily effectuate relief from applicable density limitations.	H-14	PD	Variance Zoning Application
	To establish a project district on over 50 acres of land. (This permit process provides for a flexible and creative planning approach rather than specific land use designations. It will also allow for flexibility in location of specific uses and mixes of structural alternatives).	H-15	PD	Project District Application
	To conduct agricultural tourism activities (construction, use, or activities) in the state agricultural land districts that do not conform to section 25-4-15(d) in Hawai'i County Code. (This would apply to state land use agricultural or rural districts.)	H-16	PD	Special Permit Application


**Table 3-8. Maui County Activity Checklist**

	Possible Activity to be Performed	Permit Packet Number	Department	Name of Permit
<b>Environmental Permits and Reviews</b>				
	To construct a structure or perform activities that may have significant environmental impacts as defined by HRS Chapter 343 Environmental Impact Statements law.	M-1	PD	Environmental Assessment/Impact Determination
	To construct structures or perform activities not permitted within the Maui "Shoreline Setback Area" as defined in Shoreline Rules for the Maui Planning Commission.	M-2	PD	Certified Shoreline/Shoreline Setback Variance
	To construct structures or perform activities that would require an amendment to the boundaries of any special management area map on Maui as defined as a "development" in Special Management Area Rules, Maui Planning Commission.	M-3	PD	Amendment to Special Management Area Maps
	To construct a structure or perform an activity that has a total cost fair market value of \$125,000 or more; or has significant adverse environmental or ecological effect within the Maui Special Management Area, as defined as a "development" pursuant to Special Management Area Rules, Maui Planning Commission.	M-4	PD	Special Management Area Use Permit
	To construct structures in areas subject to flood hazards.	M-5	PD	Flood Development Permit
	To discharge wastewater that is processed at Maui County's Wastewater Treatment facilities.	M-6	DEM	Wastewater Discharge Permit
	To construct structures or perform activities not permitted within the Lana'i "Shoreline Setback Area" as defined in Shoreline Setback Rules and Regulations for the Lana'i Planning Commission.	M-7	MC Lana'i	Lana'i Certified Shoreline/Shoreline Setback Variance
	To construct a structure or perform an activity that has a total cost fair market value of \$125,000 or more; or has significant adverse environmental or ecological effect within the Lana'i Special Management Area, as defined as a "development" pursuant to Special Management Area Rules, Lana'i Planning Commission .	M-8	MC Lana'i	Lana'i Special Management Area Permit
	To construct structures or perform activities not permitted within the Moloka'i "Shoreline Setback Area" as defined in Rules of the Moloka'i Planning Commission relating to the Shoreline Area.	M-9	MC Moloka'i	Moloka'i Certified Shoreline/Shoreline Setback Variance
		No Packet		


**Table 3-8. Maui County Activity Checklist (continued)**

	Possible Activity to be Performed	Permit Packet Number	Department	Name of Permit
<b>Construction and Operation Permits</b>				
	To discharge wastewater into Maui County's wastewater collection or treatment facilities.	M-11	DEM	Wastewater Hauler Permit
	To handle explosives and/or blasting agents.	M-12	DFPS	Explosives & Blasting Agent Permit
	To install fire sprinklers, water mains for fire protection, fire hydrants, and fire alarms.	M-13	DFPS	Fire Protection Permit
	To use or operate, repair or modify a pipeline for the transportation of flammable or combustible liquids.	M-14	DFPS	Flammable & Combustible Tank Permit
	To utilize flammable spray finishes for any facility.	M-15	DFPS	Flammable Finish Facility Application
	To handle hazardous materials.	M-16	DFPS	Hazardous Materials Permit
	To store, use, handle, or dispense LP gas, or to install or maintain LP gas tanks.	M-17	DFPS	Liquefied Petroleum Gases Permit
	To erect any temporary structure larger than 700 square feet in size.	M-18	DFPS	Temporary Structure Permit
	To construct, alter, move, demolish, repair or use any building or structure.	M-19	PWD	Building Permit
	To use, occupy or change existing occupancy classification of a building, structure or portion thereof.	M-20	PWD	Certificate of Occupancy Permit
	To construct, reconstruct, remove or repair any driveway on a County roadway.	M-21	PWD	Driveway Permit
	To perform any type of electrical work.	M-22	PWD	Electrical Permit
	To temporarily store soil, sand, gravel, rock, or any similar material; to uproot and remove from the surface of the ground any vegetation including trees, timber, shrubbery and plants. A grading permit is required for the evacuation of fill.	M-23	PWD	Grading & Grubbing Permits
	To operate vehicles on public roads whose dimensions or weights, including loads, or both exceed the limits set by Hawai'i Revised Statutes, Section 291.	M-24	PWD	Moving Permit
	To perform work on County highways when a County roadway will be dug up, undermined, broken up, or disturbed in any way.	M-25	PWD	Perform Work on County Highway Permit
	To perform any type of plumbing work.	M-26	PWD	Plumbing/Gas Permit


**Table 3-8. Maui County Activity Checklist (continued)**

	Possible Activity to be Performed	Permit Packet Number	Department	Name of Permit
Land Use Permits				
	To use property in a manner not allowed under the current zoning of that particular parcel of land.	M-27	PD	Change in Zoning Permit
	To develop an "unusual and reasonable" land use within the Agricultural and Rural Districts of Wailuku, Makawao, Lāhainā, and Hana, other than permissible agricultural or rural uses within those districts.	M-28	PD	Special Use Permit—State Land Use Commission
	To revise or amend an existing Community Plan for the following areas: Hana, Kaho'olawe, Kīhei-Mākena, Lana'i, Makawao-Pukalani-Kula, Moloka'i, Pā'ia-Ha'ikū, Wailuku-Kahului, and West Maui.	M-29	MC	Community Plan Amendment Application
	To propose a land use that is not specifically permitted, but is related or compatible to those uses permitted within a given use zone for a limited period of time—Maui and Lana'i.	M-30	MC Lana'i Moloka'i	Conditional Use Permit – Lana'i and Moloka'i
	To amend or reclassify State Land Use District boundaries involving lands 15 acres or less presently classified in the Agricultural, Rural or Urban Districts as defined in HRS Section 205-3.1.	M-31	PD	District Boundary Amendment — State Land Use Commission
	To receive a tentative planned development approval (PD1, or Step 1), tentative sketch plan approval, (PD2, or Step 2), and unified site and building program approval (PD3, or Step 3) for parcels of land greater than 3 acres in the state urban district or parcels of land greater than 10 acres outside the state urban districts.	M-32	PD Moloka'i	Planned Development Approval
	To develop tracts of land designated as project districts by the adopted community plans—Maui & Lana'i.	M-33	PD Lana'i Moloka'i	Project District Development Approval
	To establish general planning and development control parameters as required for a few zoning districts of Title 19, Maui County Zoning Ordinance, including regional park and golf course park districts.	M-34	PD	Project Master Plan Preview

**Table 3-8. Maui County Activity Checklist (continued)**

	Possible Activity to be Performed	Permit Packet Number	Department	Name of Permit
	To develop a structure that would require specific, similar, or related accessory uses as provided for under Title 19, Maui County Zoning Ordinance. This would include the Hotel Districts, B-2 Community Business District, and B-R Resort Commercial District.	M-35	PD	Special Accessory Use Permit
	To establish general planning and development control to specify the uses of land, and the layout of the project's landscaping, circulation, and buildings for district or uses which also require a Project Master Plan Review.	M-36	PD	Development Plan Review
	To propose certain special uses within the various zoning districts on Maui and Lana'i.	M-37	PD Lana'i Moloka'i	County Special Use Permit
	To obtain variances from the strict application of any zoning, subdivision or building ordinances. To appeal a decision or order of, or alleged error by, any department charged with the enforcement of zoning, subdivision, and building ordinances.	M-38	PD	Board of Variance and Appeals
	To verify the County Zoning, Community Plan, State Land Use District designations, Flood Zone and other special districts for parcels of land located within Maui County.	M-39	PD	Zoning and Flood Confirmation Form
	To conduct activities that would require the subdivision or consolidation of land.	M-40	PWD	Subdivision Applications
	To develop an "unusual and reasonable" land use within the Agricultural and Rural Districts of Lana'i, other than permissible agricultural or rural uses within those districts.	M-41	MC Lana'i	Lana'i Special Use Permit—State Land Use Commission
	To propose a land use that is not specifically permitted, but is related or compatible to those uses permitted within a given use zone for a limited period of time—Moloka'i.	M-42	MC Moloka'i	Moloka'i Conditional Use Permit
	To propose certain special uses within the various zoning districts on Moloka'i.	M-43	MC Moloka'i	Moloka'i County Special Use Permit Application
	To develop tracts of land designated as project districts by the adopted community plans—Moloka'i.	M-44	MC Moloka'i	Moloka'i Project District Development Approval
	To conduct certain "unusual and reasonable" land use activities within the Agricultural and Rural Districts of Moloka'i, other than permissible agricultural or rural uses within those districts.	M-45	MC Moloka'i	Moloka'i Special Use Permit—State Land Use Commission

**Table 3-8. Maui County Activity Checklist (continued)**

	Possible Activity to be Performed	Permit Packet Number	Department	Name of Permit
	To conduct an emergency use, activity, or operation that qualifies as "development" or has significant adverse environmental or ecological effect within the Lana'i Special Management Area, when there is an imminent threat to a legally habitable structure, or when public infrastructure is at risk of failure which would substantially affect public health and safety.	M-46	MC Lana'i	Lana'i Special Management Area Emergency Permit
	To conduct any use, activity, or operation that qualifies as "development"; establish special controls on development within the area along the shoreline.	M-47	PD	Special Management Area Assessments
	To conduct an emergency use, activity, or operation that qualifies as "development" or has significant adverse environmental or ecological effect within the Maui Special Management Area, when there is an imminent threat to a legally habitable structure, or when public infrastructure is at risk of failure which would substantially affect public health and safety.	M-48	PD	Maui Special Management Area Emergency Permit
	To conduct an emergency use, activity, or operation that qualifies as "development" or has significant adverse environmental or ecological effect within the Moloka'i Special Management Area, when there is an imminent threat to a legally habitable structure, or when public infrastructure is at risk of failure which would substantially affect public health and safety.	No Packet	PD	Moloka'i Special Management Area Emergency Permit
---		M-49		

**(Project Name) Geothermal Project  
Drilling Program**

Well Number: \_\_\_\_\_

Site: \_\_\_\_\_

Wellhead Location: YYYYYYY North - XXXXXX East  
Elevation: ### feet msl  
(approximate)

Target Well Depth: ##### feet ± (measured depth).  
Note: All depths quoted in this program are measured with respect to ground level (or KB).

Objective: Drill a (new full-diameter vertical well; new full-diameter directional well; new exploration well; new slimhole; etc.) to confirm and evaluate geothermal production.

Summary

(A full project summary should be included in this section describing: where the well is to be drilled, what the intended target is, which geologic formations are to be drilled through, what subsurface conditions are expected, what data the expected conditions are based on, what the lost circulation procedures are, what the expected well casing program is, what alternative plans in place are, what safety procedures and protocols are in place, etc.). Include supporting figures, such as a project location map, well pad engineering plans, well section diagram, proposed BOP diagram, etc.

Drilling Procedure

A step-by-step description of the intended drilling program should be included in this section. Specifications for the directional section of the well are to be included here as well. A generic itemization of basic drilling procedures follows. These are meant to be guidelines only, as in a

real drilling program this section would contain explicit drilling procedures and details including all dimensions.

- 1.1. Detailed operations for how the project location site will be prepared. (Include figures).
- 1.2. Detailed operations for mobilizing the rig and all equipment to the project location. (Include table on rig specifications). (Include figures where helpful).
- 1.3. Details on monitoring procedures and protocol for drilling operations.
- 1.4. Detailed operations for rigging up to begin drilling activities.
- 1.5. Details on drilling fluids to be used and additives that may be employed. (Include table of mud properties and additives) (Figure 3.xDrillFluidProps).
- 1.6. Details on procedures to be used if circulation losses are encountered (including LCM and cement plugs).
- 1.7. Details on planned drilling diameter and depth for first stage hole size, hole cleaning procedures, casing grade and type to be used, cement type and additives to be used, top job procedures that may be employed (Include figure or table showing cement calculations) (Figure 3.xCementCalcs).
- 1.8. Detailed operations for changes to equipment for next stage of drilling. (Include figure showing proposed BOP configuration).
- 1.9. Repeat items 1.3 through 1.7 for any additional stages of the well, making the necessary modifications for the different casing sizes.
- 1.10. Details on criteria to be used for determining the well completion depth, and detailed procedures for the completion of the well once permeable zones have been encountered (or not, in the case of a dry hole) including any changes to the drilling fluid, key decision factors and decision points, liner running procedures, flushing hole, etc.



1.11. Detailed procedures for testing productivity or injectivity of well.

1.12. Detailed operations for rigging up to begin drilling activities.

#### Drilling Fluids and Corrosion Control

Details on the mud program to be used should be included in this section. Actual well conditions encountered during drilling will dictate the final type and rheological properties of the drilling fluid. The following rheological conditions should be provided (at minimum):

#### **Dispersed Mud**

Weight	(specific gravity)
pH	
Marsh viscosity	(seconds)
Plastic viscosity	(cp)
Yield point	lbs/100 sq.ft.)
10 min Gel	lbs/100 sq.ft.)
Water loss	(volume/minute)
Wall cake	(inches)
Sand content	%

#### Aerated Water or Aerated Mud

Details on the aerated water or mud program to be used should be included in this section, including criteria for determining the need for a change in drilling fluids.

#### Corrosion Control

Details on the procedures to be used to control corrosion should be included in this section.

#### Casing Design Criteria

Details on the casing design to be used should be included in this section. Below is a sample of a table to include describing the parameters used in the design of the casing program. Details for each stage of the well should be included.

Casing	Burst (psi)	Collapse (psi)	Tension (lb)
(diameter), (grade), (weight), (type)			

The calculations made for the casing and the corresponding safety factors are typically base on the expected stresses to be exerted and their stress calculations for burst pressure, collapse pressure and axial tension.

#### Geological Sampling Procedures

Details on other activities which will be occurring during the drilling of the well should be included in this section, for example:

- Geological Sampling Program - specific sampling requirements, labeling procedures, storage requirements, etc.
- Bulk Unwashed Cuttings – number of samples to collect, sample depths, sample intervals, sample size (volume or weight), labeling procedures, etc.
- Washed and Dried Cuttings - number of samples to collect, sample depths, sample intervals, sample size (volume or weight), labeling procedures, etc.
- Mud Log Report – recording system to be used, frequency of reporting, recording additional data (mud losses, steam entries, downtime, fishing), etc.

#### Drilling Standards

Details on standards for the drilling should be included in this section, for example

- Changes in the Program – procedures for making changes to the drilling program, persons who should be notified of any changes, and the designation of a person (typically

the Drilling Supervisor) who is to be responsible for ensuring that the following standards and procedures are applied.

- Units – designation of the units preferred for use in documentation of all operations and reporting.

### Project Vendors

Details on which vendors are under contract, contact information, main office location and pending schedules should be included. Potential substitutes or local contractors may be included for emergency situations.

### Reporting Requirements

Details on the required frequency, timing and the responsible party for project reporting (to the operating company, for example:

Daily I.A.D.C. Report:	Toolpusher-Contractor	06:00 hrs
Daily Mud Report:	Mud Eng.-Contractor	06:00 hrs
Daily Drilling Report:	Drilling Supervisor	08:00 hrs
Daily Cost Report:	Drilling Supervisor	08:00 hrs
Daily Geology Report:	Well Site Geologist/Mud Logger	08:00 hrs
Casing /Cementing Report:	As required, Drilling Supervisor	Following morning
Incident Report:	As required, Drilling Supervisor	Within 12 hrs
General Safety Meeting:	Weekly, Toolpusher-Contractor	Following morning
Final Well Report	End of Well, Drilling Supervisor	Within 2 weeks

### Other Drilling Program Procedures

Details on other procedures required for the safe and successful completion of the drilling program should be included in this section, for example:

- Well Control – procedures on when and how the well should be shut in, required testing frequency of BOP drills, slow circulation rate (SCR) frequency, emergency shut down operations and frequency of equipment functionality tests.
- Pressure Testing Schedule – required testing frequency, duration and pressures for testing BOP equipment, wellhead and casing.
- Accumulator Test – procedures for conducting accumulator test and required testing frequency.
- Blow Out Preventer (BOP) – maintenance procedures and requirements for well control equipment.
- Tripping – procedures for tripping pipe, reporting requirements for all tripping operations (in and out of the hole, logging and casing running).
- Flow Checks - timing of and required frequency for conducting flow checks.
- Meetings –required frequency, personnel and reporting for all meeting types to be held